

# M52470AP

## 4-INPUT 3-CHANNEL ANALOG SWITCH

### DESCRIPTION

The M52470AP is a semiconductor integrated circuit containing analog switches designed for use in a video system. It contains two audio switches and one video switch. Each switch has four inputs and can be simultaneously controlled. In addition, the video switch contains an amplifier with again of about 7.0dB.

### FEATURES

- Built-in analog switches for video signals and stereophonic audio signals
- Wide-band video switch.....DC to 10MHz
- Excellent crosstalk characteristics  
..... Standard 60dB at 5MHz

### APPLICATION

Video equipment

### TABLE OF SWITCH MODES

SW \ Pin	4	6
1	GND	GND
2	GND	Vcc
3	Vcc	GND
4	Vcc	Vcc

### RECOMMENDED OPERATING CONDITION

- Supply voltage range.....5V to 14V  
 Rated supply voltage.....9V, 12V

### PIN CONFIGURATION (TOP VIEW)

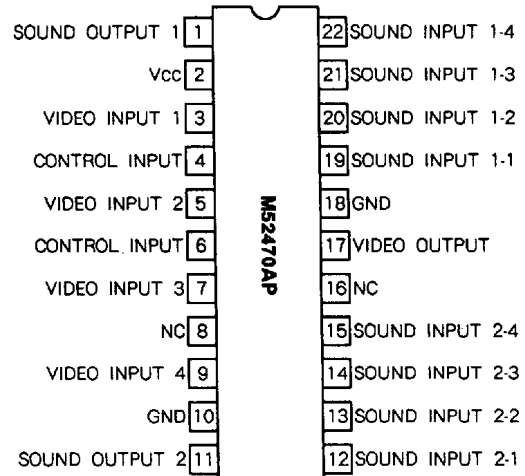

Outline 22P4

NC : NO CONNECTION

### BLOCK DIAGRAM

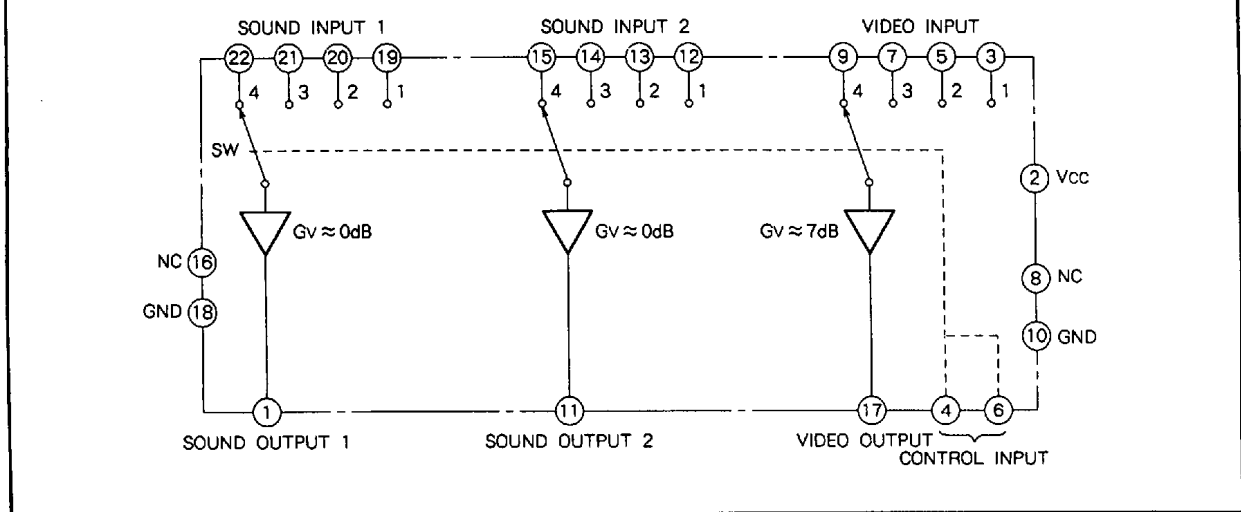

6249826 0021478 754



**M52470AP**

**4-INPUT 3-CHANNEL ANALOG SWITCH**

**ABSOLUTE MAXIMUM RATINGS** (Ta = 25°C, Vcc = 12V unless otherwise noted)

Symbol	Parameter	Conditions	Ratings	Unit
V <sub>cc</sub>	Supply voltage		14	V
V <sub>ic</sub>	Input control voltage		0~V <sub>cc</sub>	V
P <sub>d</sub>	Power dissipation		1.6	W
K <sub>θ</sub>	Thermal derating		16	mW/°C
T <sub>opr</sub>	Operating temperature		-20~+75	°C
T <sub>stg</sub>	Storage temperature		-40~+125	°C
V <sub>in</sub>	Input signal voltage		-0.5~V <sub>cc</sub> +0.5	V
I <sub>so</sub>	Output pin outflow current	Audio	10	mA
I <sub>vo</sub>		Video	10	mA

**ELECTRICAL CHARACTERISTICS** (Ta = 25°C, Vcc = 12V unless otherwise noted)

Symbol	Parameter	Test conditions	Limits			Unit
			Min.	Typ.	Max.	
I <sub>cc</sub>	Circuit current			21	30	mA
V <sub>idc</sub>	Input bias voltage	Sound measuring pins ②, ③, ④, ⑤ ⑥, ⑦, ⑧, ⑨	5.8	6.5	7.2	V
		Video measuring pins ③, ⑤, ⑦, ⑨	4.0	4.4	4.8	
V <sub>odc</sub>	Output bias voltage	Sound measuring pins ①, ⑩	5.2	5.8	6.4	V
		Video measuring pin ⑩	5.0	5.5	6.0	
V <sub>op</sub>	Output DC offset voltage	Measuring pins ①, ⑩, ⑩		5.0	100	mV
V <sub>th</sub>	Control pin threshold voltage	Measuring pins ①, ⑩, ⑩	2.3	2.5	2.7	V
G <sub>v</sub>	Voltage gain	Sound: f=1kHz, V <sub>IN</sub> =1Vrms; Measuring pins ①, ⑩	-0.5	-0.1		dB
		Video: f=1MHz, V <sub>IN</sub> =0.5Vrms; Measuring pin ⑩	6.0	7.0	8.0	
THD	Total harmonic distortion	f=1kHz, V <sub>out</sub> =1Vrms; Measuring pins ①, ⑩		0.01	0.2	%
V <sub>n</sub>	Output noise voltage	Sound: R <sub>g</sub> =620Ω; Band: 15kHz; Measuring pins ①, ⑩		3.0	50	μVrms
		Video: R <sub>g</sub> =75Ω; Band: 10MHz; Measuring pin ⑩		0.5	1.0	mVrms
CT	Crosstalk	Sound: f=1kHz, V <sub>IN</sub> =1Vrms; Measuring pins ①, ⑩	80	95		dB
		Video: f=5MHz, V <sub>IN</sub> =0.5Vrms; Measuring pins ⑩	50	60		
I <sub>in</sub>	Control pin input current	Measuring pins ④, ⑥	-20	-2.0	1.0	μA
Z <sub>in</sub>	Input impedance	Sound measuring pins ②, ③, ④, ⑤ ⑥, ⑦, ⑧, ⑨; f=1kHz, 20kHz	47	58		kΩ
		Video measuring pins ③, ⑤, ⑦, ⑨; f=100kHz	16	26		

# M52470AP

## 4-INPUT 3-CHANNEL ANALOG SWITCH

### INPUT/OUTPUT EQUIVALENT CIRCUIT (V<sub>CC</sub> = 12V)

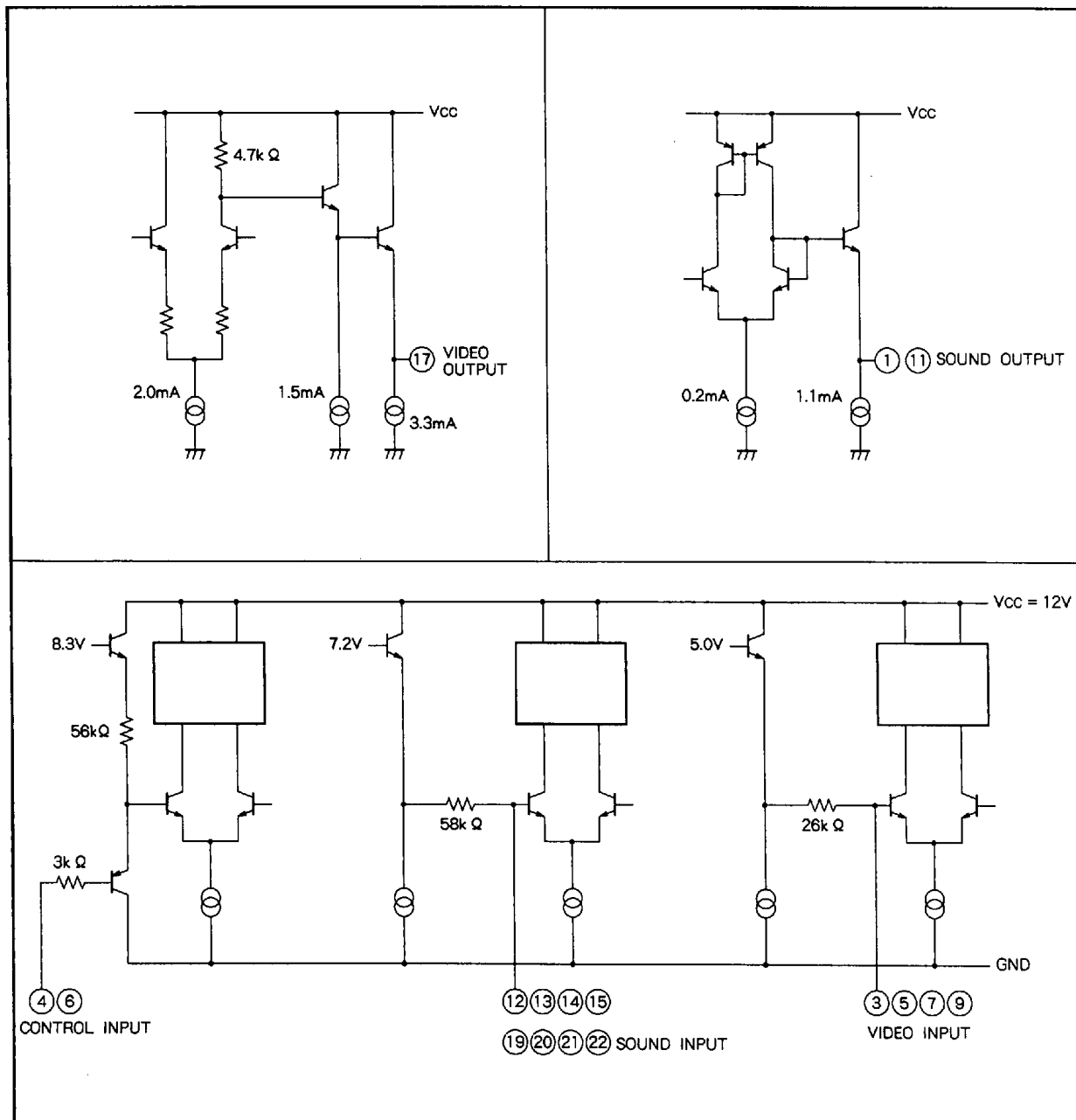

6249826 0021480 302



4-INPUT 3-CHANNEL ANALOG SWITCH

TYPICAL CHARACTERISTICS

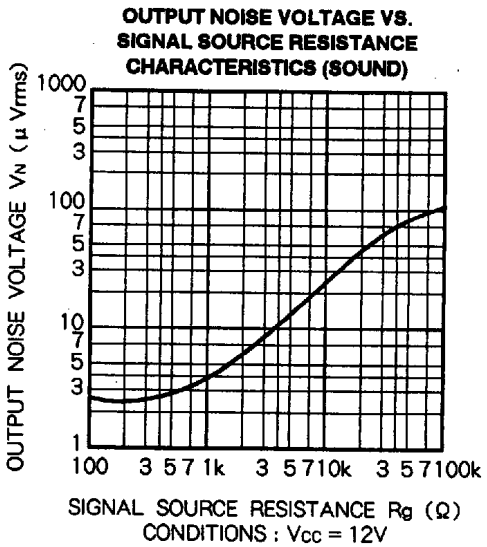
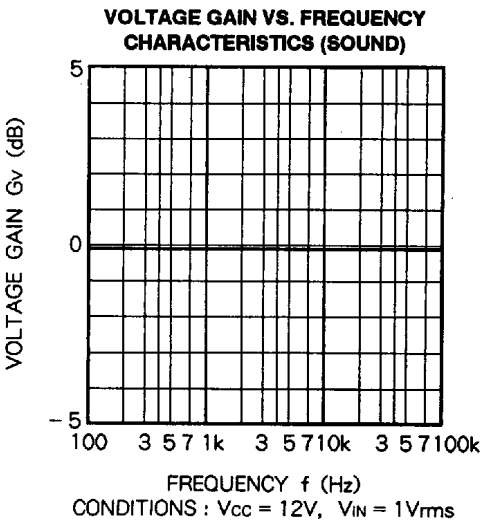
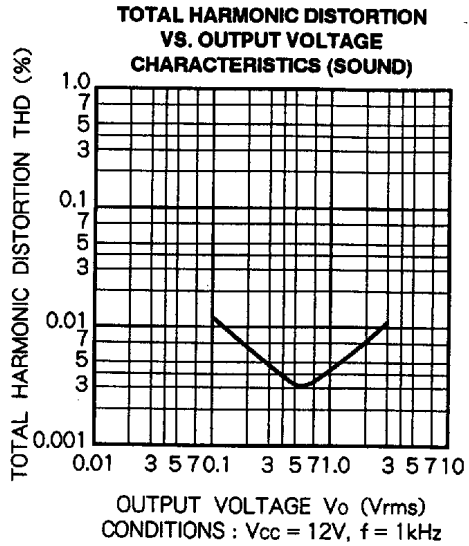
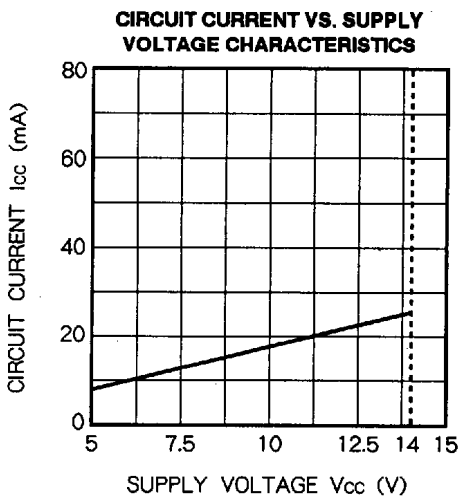
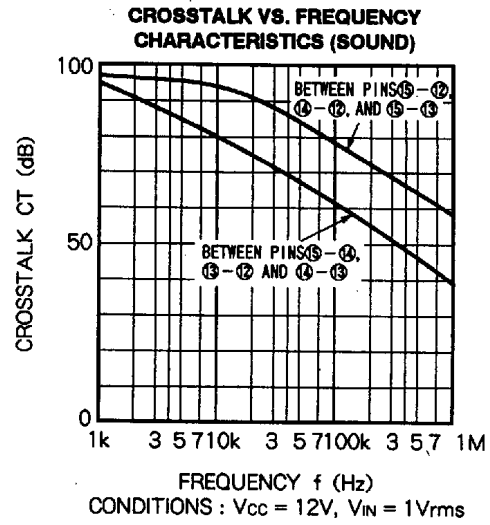
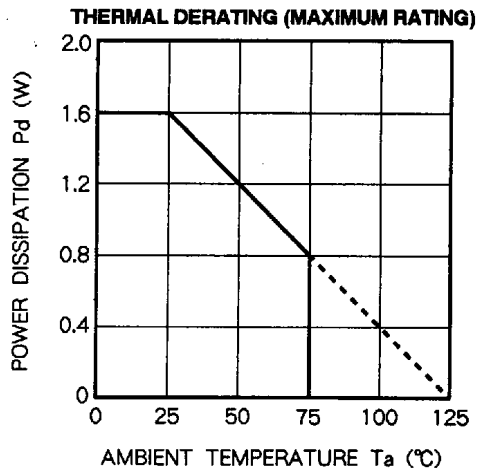

6249826 0021481 249



M52470AP

4-INPUT 3-CHANNEL ANALOG SWITCH

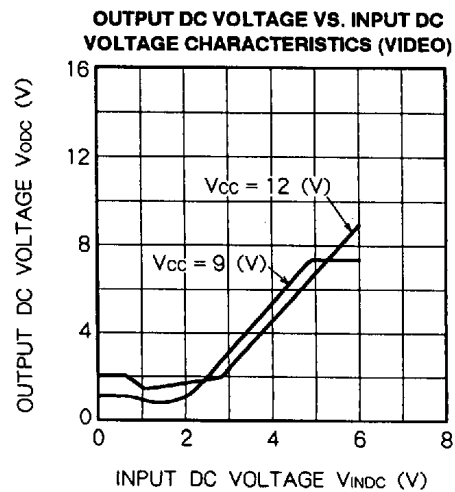
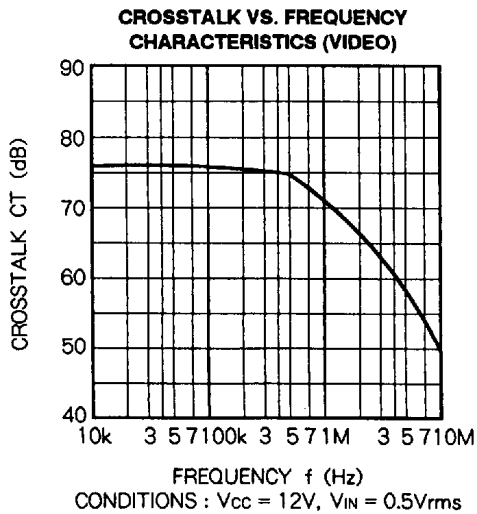
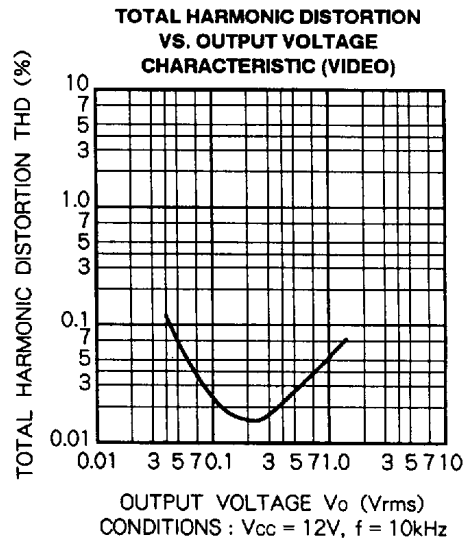
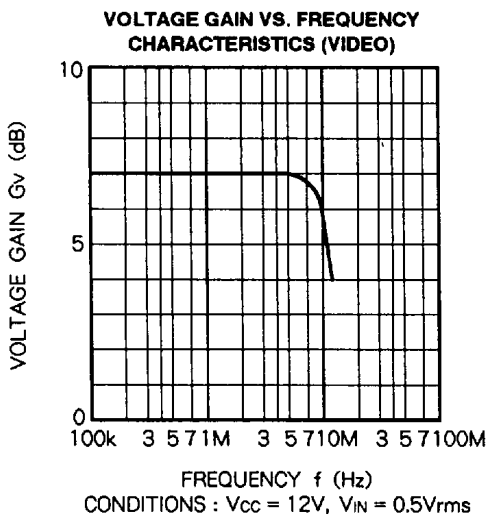
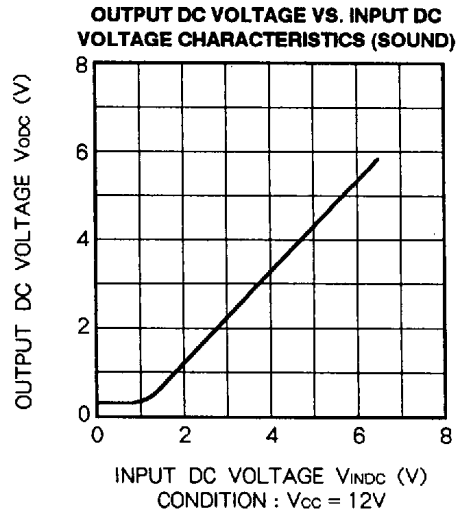
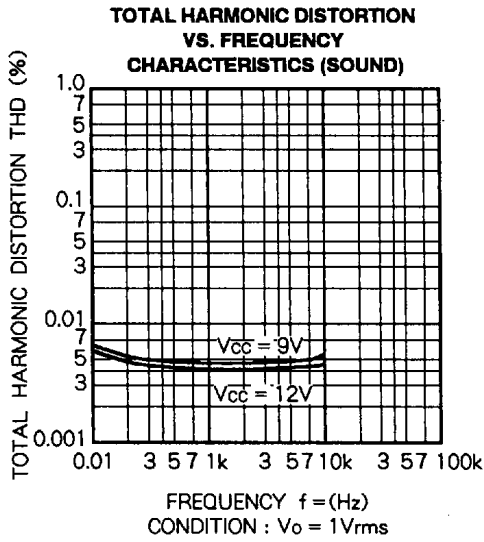

6249826 0021482 185



# M52470AP

## 4-INPUT 3-CHANNEL ANALOG SWITCH

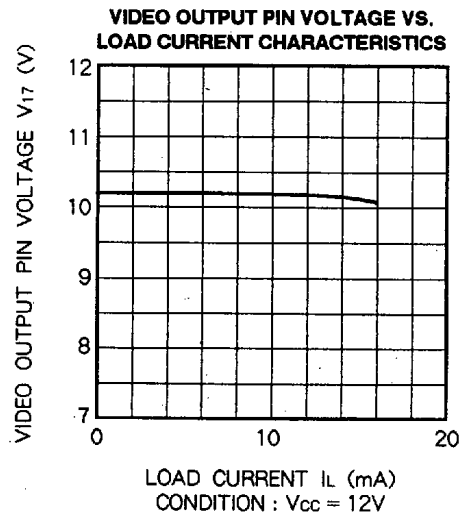
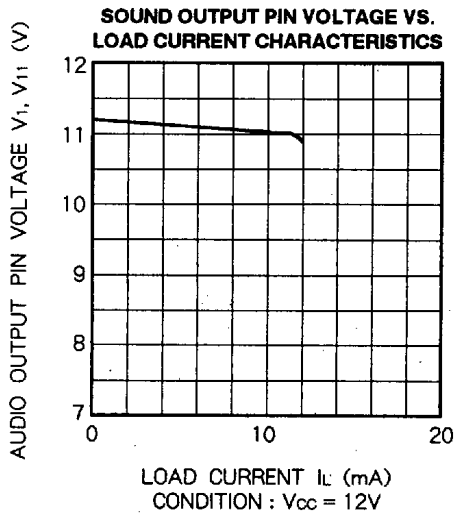

### APPLICATION EXAMPLE

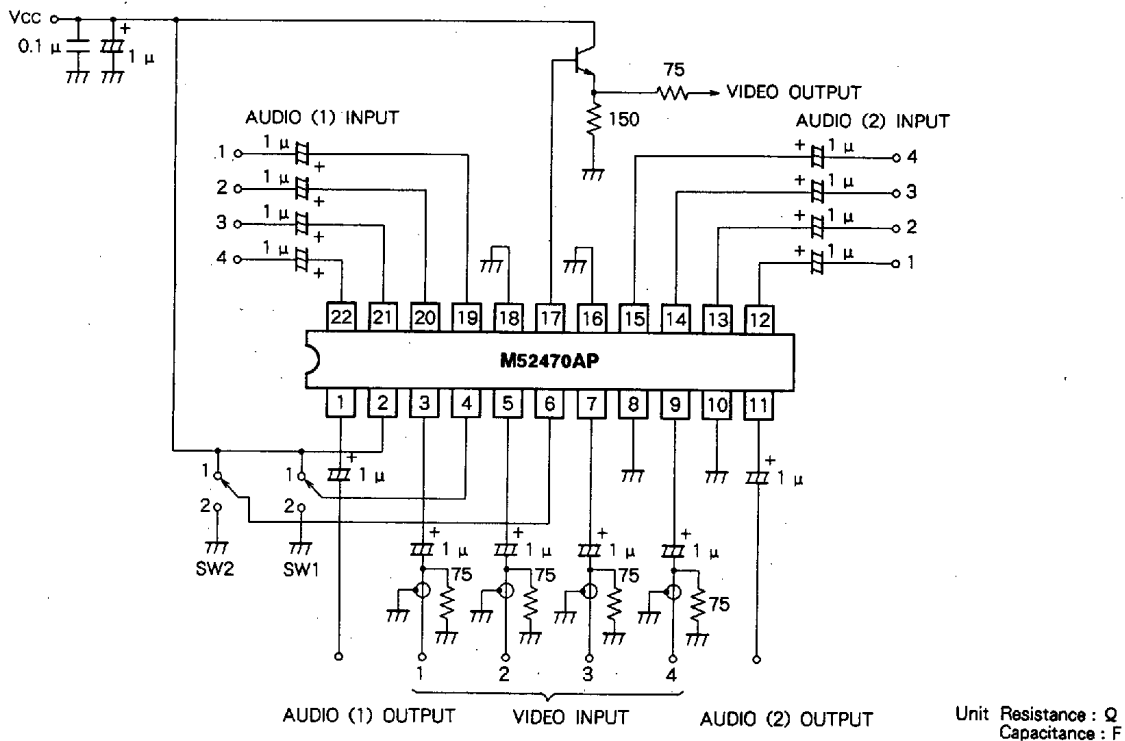

### PRECAUTIONS FOR APPLICATION

Note the following when using the M52470AP. These notes should be fully taken into consideration.

- 1) A large signal to the audio input pins may disturb the video output signal, in case the voltage at the input pin drops to 1V or under (equivalent to AC 10V<sub>P-P</sub> at  $V_{CC} = 12V$ ).

Make some arrangements so that no input signal of large amplitude may enter.

- 2) If the video circuit input pins are terminated by means of 75 $\Omega$  resistors, the capacitance of coupling capacitors might become larger (several tens  $\mu F$ ). When switching power on in that case, the video output will be unstable until the bias to the video output circuit becomes stable. Care should be taken when designing circuits and systems.

6249826 0021483 011

