



1.0 Hz to 100 kHz
Fixed Frequency

32 Pin DIP
6-Pole Filters

Description

The D66 and DP66 Series of small 6-pole fixed-frequency, precision active filters provide high performance linear active filtering in a compact 32-pin DIP package, with a broad range of corner frequencies and a choice of transfer functions. Individual D66 filters can serve in low-pass or high-pass applications (DP66, low-pass only) or be combined to create custom band-pass or band-reject filters. These fully self-contained units require no external components or adjustments. Each model comes factory tuned to a user-specified corner frequency between 1 Hz and 100 kHz (DP66, 1 Hz to 5 kHz) and operate with low total harmonic distortion over a wide dynamic input voltage range from non-critical +/-5V to +/-18V power supplies.

Features/Benefits:

- Low harmonic distortion and wide signal-to-noise ratio to 16 bit resolution.
- Compact 1.8"L x 0.8"W x 0.3"H minimizes board space requirements.
- Plug-in ready-to-use, reducing engineering design and manufacturing cycle time.
- Factory tuned, no external clocks or adjustments needed
- Broad range of transfer characteristics and corner frequencies to meet a wide range of applications.

Applications

- Anti-alias filtering
- Data acquisition systems
- Communication systems and electronics
- Medical electronics equipment and research
- Aerospace, navigation and sonar applications
- Sound and vibration testing
- Acoustic and vibration analysis and control
- Noise elimination
- Signal reconstruction



| Available Low-Pass Models: | | Page |
|----------------------------|--------------------------------------|------|
| D66L6B | 6-pole Butterworth | 2 |
| DP66L6B | 6-pole Butterworth (Low Power) | 2 |
| D66L6L | 6-pole Bessel | 2 |
| DP66L6L | 6-pole Bessel (Low Power) | 2 |

| Available High-Pass Models: | |
|-----------------------------|--------------------------|
| D66H8B | 6-pole Butterworth |

| |
|---|
| General Specifications: |
| Pin-out/package data & ordering information |



| Model | D66L6B & DP66L6B | D66L6L & DP66L6L | Model | D66H6B |
|---|--|--|---|---|
| Product Specifications | Low-Pass | Low-Pass | | High-pass |
| Transfer Function | 6-Pole, Butterworth | 6-Pole, Bessel | Transfer Function | 6-Pole, Butterworth |
| Size | 1.8" x 0.8" x 0.3" | 1.8" x 0.8" x 0.3" | Size | 1.8" x 0.8" x 0.3" |
| Range f_c D66 DP66 | 1 Hz to 100 kHz 1 Hz to 5 kHz | 1 Hz to 100 kHz 1 Hz to 5 kHz | Range f_c D66 DP66 | 1 Hz to 100 kHz Not Available |
| Theoretical Transfer Characteristics | Appendix A Page 8 | Appendix A Page 3 | Theoretical Transfer Characteristics | Appendix A Page 28 |
| Passband Ripple (theoretical) | 0.0 dB | 0.0 dB | Passband Ripple (theoretical) | 0.0 dB |
| DC Voltage Gain (non-inverting) | 0 ± 0.1 dB max. 0 ± 0.05 dB typ. | 0 ± 0.1 dB max. 0 ± 0.05 dB typ. | Voltage Gain (non-inverting) | 0 ± 0.1 dB to 100 kHz 0 ± 0.05 dB to 120 kHz |
| Stopband Attenuation Rate | 36 dB/octave | 36 dB/octave | Stopband Attenuation Rate | 36 dB min. |
| Power Bandwidth | | | Power Bandwidth | (-6dB) 1 MHz |
| Power Bandwidth | | | Power Bandwidth | 120 kHz |
| Cutoff Frequency Stability Amplitude Phase | f _c ± 1% max. ± 0.01% /°C -3dB -270° | f _c ± 1% max. ± 0.01% /°C -3dB -155° | Cutoff Frequency Stability Amplitude Phase | f _c ± 1% max. ± 0.01% /°C -3dB -270° |
| Filter Attenuation (theoretical) | 0.29 dB 0.80 f _c 3.01 dB 1.00 f _c 60.0 dB 3.16 f _c 80.0 dB 4.64 f _c | 1.89 dB 0.80 f _c 3.01 dB 1.00 f _c 60.0 dB 5.41 f _c 80.0 dB 7.99 f _c | Filter Attenuation (theoretical) | 80.0 dB .21 f _c 60.0 dB .32 f _c 3.01 dB 1.00 f _c 0.00 dB 2.5 f _c |
| Phase Match¹ | 0 - 0.8 f _c ± 2° max. ± 1° typ. 0.8 f _c - 1.0 f _c ± 3° max. ± 1.5° typ. | 0 - f _c ± 2° max. ± 1° typ. | Phase Match¹ | f _c - 100 kHz ± 3° max. ± 1.5° typ. |
| Amplitude Accuracy (theoretical) | 0 - 0.8 f _c ± 0.2 dB max. ± 0.1 dB typ. 0.8 f _c - 1.0 f _c ± 0.3° dB max. ± 0.15° dB typ. | 0 - f _c ± 0.2 dB max. ± 0.1 dB typ. | Amplitude Accuracy (theoretical) | 1.0 - 1.25 f _c ± 0.3 dB max. ± 0.15 dB typ. 1.25f _c -100kHz ± 0.2 dB max. ± 0.1 dB typ. |
| Total Harmonic Distortion @ 1 kHz D66 DP66 | <-100 dB typ. <-80 dB typ. | <-100 dB typ. <-80 dB typ. | Total Harmonic Distortion @ 1 kHz D66 | <-88 dB typ. |
| Wide Band Noise (5 Hz - 2 MHz) | 200 μVrms typ. | 200 μVrms typ. | Wide Band Noise (5 Hz - 2 MHz) | 400 μVrms typ. |
| Narrow Band Noise (20 Hz - 100 kHz) | 50 μVrms typ. | 50 μVrms typ. | Narrow Band Noise (20 Hz - 100 kHz) | 100 μVrms typ. |
| Filter Mounting Assembly | FMA-01A | FMA-01A | Filter Mounting Assembly | FMA-01A |

1. Unit to unit match for the same transfer function, set to the same frequency and operating configuration, and from the same manufacturing lot.



Specification

(25°C and Vs ± 15 Vdc)

Pin-Out and Package Data Ordering Information

Analog Input Characteristics¹

| | |
|-------------------|------------------------|
| Impedance | 10 kΩ min. |
| Voltage Range | ± 10 V _{peak} |
| Max. Safe Voltage | ± Vs |

Analog Output Characteristics

| | |
|------------------------------|-------------------------|
| Impedance(Closed Loop) | 1 Ω typ. 10 Ω max. |
| Linear Operating Range | ± 10 V |
| Maximum Current ² | ± 2 mA |
| Offset Voltage ³ | 2 mV typ. 20 mV max. |
| Offset Temp. Coeff. | 50 μV / °C |

Power Supply (±V)

| | |
|-----------------------|-----------------|
| Rated Voltage | ± 15 Vdc |
| Operating Range | ± 5 to ± 18 Vdc |
| Maximum Safe Voltage | ± 18 Vdc |
| Quiescent Current D66 | |

± 19 mA typ.
± 30 mA max.

Quiescent Current DP66

± 7.0 mA typ.
± 8.0 mA max.

Temperature

| | |
|-----------|-----------------|
| Operating | 0 to + 70 °C |
| Storage | - 25 to + 85 °C |

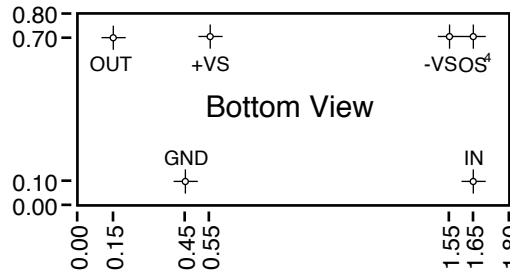
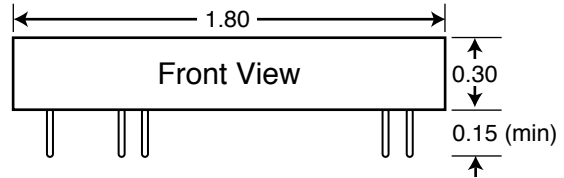
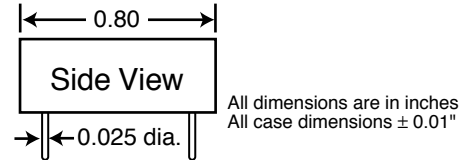
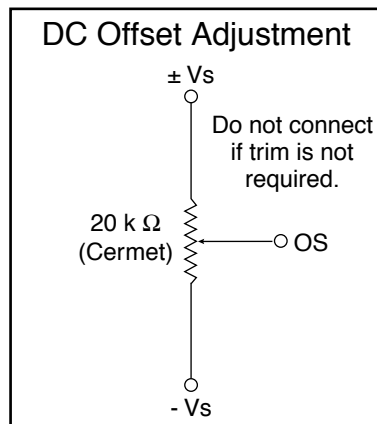

Filter Mounting Assembly-See FMA-01A

Ordering Information

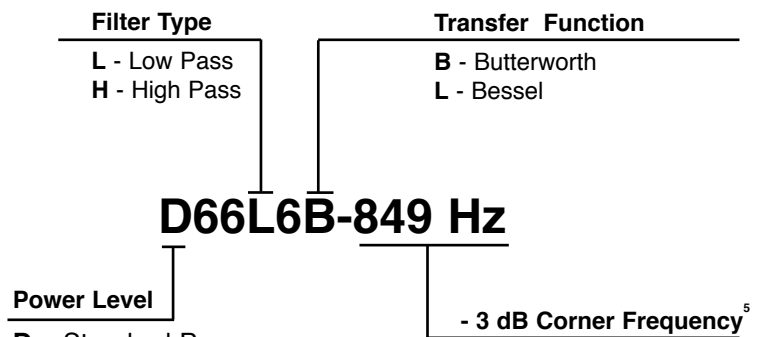

- Notes:
1. Input and output signal voltage referenced to supply common.
 2. Output is short circuit protected to common. DO NOT CONNECT TO ±Vs.
 3. Adjustable to zero.
 4. Units operate with or with out offset pin connected.
 5. How to Specify Corner Frequency:
Corner frequencies are specified by attaching a three digit frequency designator to the basic model number. Corner frequencies can range from 1.00 Hz to 100 kHz.

We hope the information given here will be helpful. The information is based on data and our best knowledge, and we consider the information to be true and accurate. Please read all statements, recommendations or suggestions herein in conjunction with our conditions of sale which apply to all goods supplied by us. We assume no responsibility for the use of these statements, recommendations or suggestions, nor do we intend them as a recommendation for any use which would infringe any patent or copyright. **IN-00D66-00**



Appendix A

Theoretical Transfer Characteristics

| f/fc (Hz) | Amp (dB) | Phase (deg) | Delay ¹ (sec) |
|--------------|-------------|----------------|-----------------------------|
| 0.00 | 0.00 | 0.00 | .430 |
| 0.10 | -0.029 | -15.5 | .430 |
| 0.20 | -0.116 | -31.0 | .430 |
| 0.30 | -0.261 | -46.5 | .430 |
| 0.40 | -0.465 | -62.0 | .430 |
| 0.50 | -0.728 | -77.4 | .430 |
| 0.60 | -1.05 | -92.9 | .430 |
| 0.70 | -1.44 | -108 | .430 |
| 0.80 | -1.89 | -124 | .430 |
| 0.85 | -2.15 | -132 | .430 |
| 0.90 | -2.42 | -139 | .430 |
| 0.95 | -2.70 | -147 | .430 |
| 1.00 | -3.01 | -155 | .430 |
| 1.10 | -3.68 | -170 | .429 |
| 1.20 | -4.44 | -186 | .428 |
| 1.30 | -5.29 | -201 | .426 |
| 1.40 | -6.23 | -216 | .422 |
| 1.50 | -7.29 | -232 | .416 |
| 1.60 | -8.46 | -246 | .401 |
| 1.70 | -9.74 | -261 | .393 |
| 1.80 | -11.1 | -275 | .376 |
| 1.90 | -12.6 | -287 | .357 |
| 2.00 | -14.2 | -300 | .335 |
| 2.25 | -18.3 | -328 | .279 |
| 2.50 | -22.6 | -351 | .228 |
| 2.75 | -26.7 | -369 | .187 |
| 3.00 | -30.7 | -385 | .156 |
| 3.25 | -34.5 | -398 | .131 |
| 3.50 | -38.1 | -408 | .111 |
| 4.00 | -44.7 | -426 | .083 |
| 5.00 | -55.9 | -449 | .052 |
| 6.00 | -65.2 | -465 | .036 |
| 7.00 | -73.2 | -476 | .026 |
| 8.00 | -80.1 | -484 | .020 |
| 9.00 | -86.2 | -490 | .015 |
| 10.0 | -91.6 | -495 | .013 |

Frequency Response

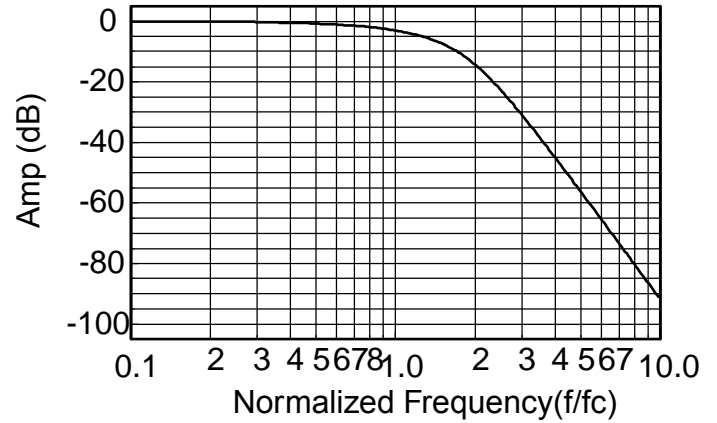

Delay (Normalized)

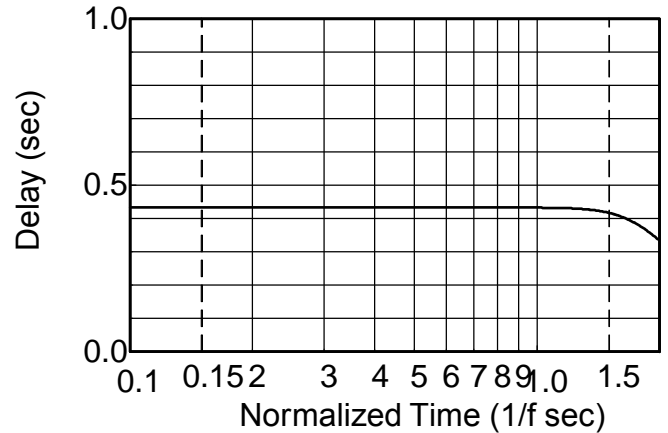

Step Response

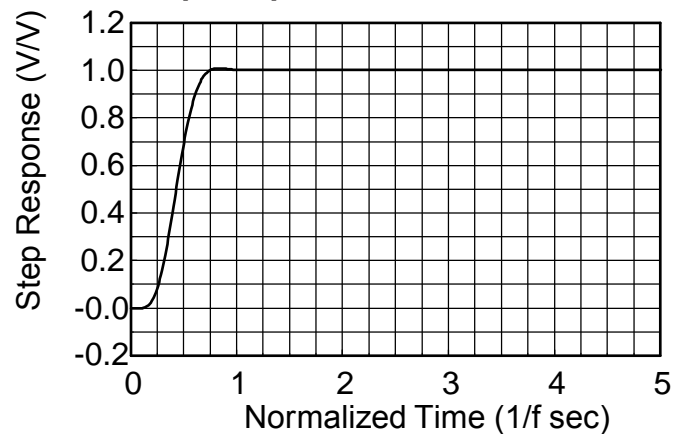

1. Normalized Group Delay:

The above delay data is normalized to a corner frequency of 1.0Hz. The actual delay is the normalized delay divided by the actual corner frequency (fc).

$$\text{Actual Delay} = \frac{\text{Normalized Delay}}{\text{Actual Corner Frequency (fc) in Hz}}$$



Appendix A

Theoretical Transfer Characteristics

| f/fc (Hz) | Amp (dB) | Phase (deg) | Delay ¹ (sec) |
|--------------|-------------|----------------|-----------------------------|
| 0.00 | 0.00 | 0.00 | .615 |
| 0.10 | 0.00 | -22.2 | .617 |
| 0.20 | 0.00 | -44.5 | .624 |
| 0.30 | 0.00 | -67.2 | .637 |
| 0.40 | 0.00 | -90.4 | .656 |
| 0.50 | -0.001 | -115 | .685 |
| 0.60 | -0.009 | -140 | .731 |
| 0.70 | -0.060 | -167 | .803 |
| 0.80 | -0.289 | -198 | .911 |
| 0.85 | -0.578 | -215 | .970 |
| 0.90 | -1.080 | -233 | 1.02 |
| 0.95 | -1.88 | -252 | 1.03 |
| 1.00 | -3.01 | -270 | 1.00 |
| 1.10 | -6.17 | -304 | .845 |
| 1.20 | -9.96 | -331 | .660 |
| 1.30 | -13.9 | -352 | .518 |
| 1.40 | -17.6 | -368 | .417 |
| 1.50 | -21.2 | -382 | .345 |
| 1.60 | -24.5 | -393 | .291 |
| 1.70 | -27.7 | -403 | .251 |
| 1.80 | -30.6 | -412 | .219 |
| 1.90 | -33.5 | -419 | .193 |
| 2.00 | -36.1 | -425 | .171 |
| 2.25 | -42.3 | -439 | .132 |
| 2.50 | -47.8 | -450 | .105 |
| 2.75 | -52.7 | -458 | .086 |
| 3.00 | -57.3 | -465 | .071 |
| 3.25 | -61.4 | -471 | .060 |
| 3.50 | -65.3 | -476 | .052 |
| 4.00 | -72.2 | -484 | .039 |
| 5.00 | -83.9 | -496 | .025 |
| 6.00 | -93.4 | -503 | .017 |
| 7.00 | -101 | -508 | .012 |
| 8.00 | -108 | -512 | .0097 |
| 9.00 | -115 | -515 | .0076 |
| 10.0 | -120 | -518 | .0062 |

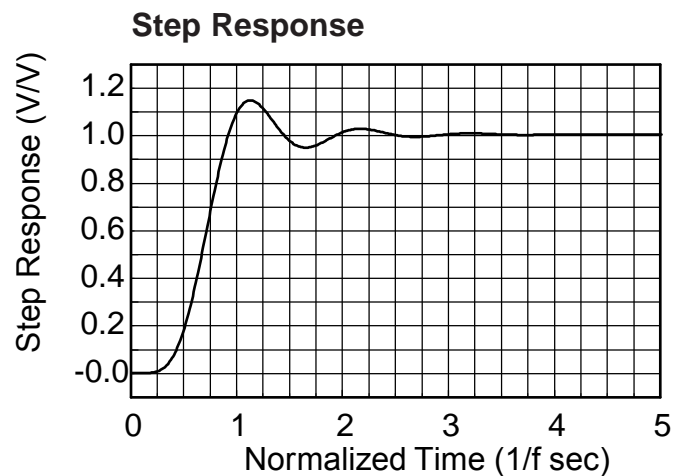
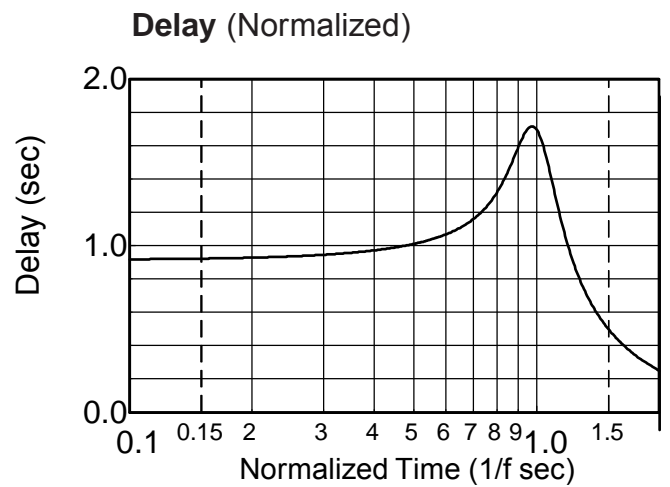
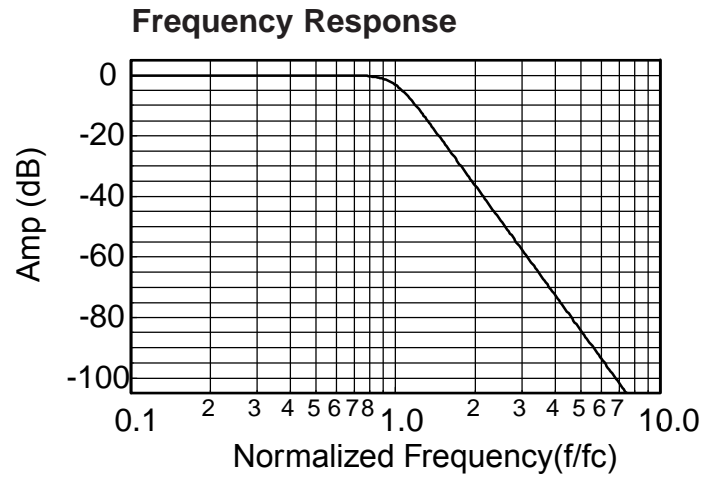

1. Normalized Group Delay:

The above delay data is normalized to a corner frequency of 1.0Hz. The actual delay is the normalized delay divided by the actual corner frequency (fc).

$$\text{Actual Delay} = \frac{\text{Normalized Delay}}{\text{Actual Corner Frequency (fc) in Hz}}$$



Theoretical Transfer Characteristics

| f/fc (Hz) | Amp (dB) | Phase (deg) | Delay¹ (sec) |
|----------------------|---------------------|------------------------|------------------------------------|
| 0.10 | -120 | 518 | 0.617 |
| 0.20 | -83.9 | 496 | 0.624 |
| 0.30 | -62.7 | 473 | 0.637 |
| 0.40 | -47.8 | 450 | 0.656 |
| 0.50 | -36.1 | 425 | 0.685 |
| 0.60 | -26.6 | 400 | 0.731 |
| 0.70 | -18.6 | 373 | 0.803 |
| 0.80 | -11.9 | 342 | 0.911 |
| 0.85 | -9.05 | 325 | 0.970 |
| 0.90 | -6.57 | 307 | 1.017 |
| 0.95 | -4.55 | 288 | 1.033 |
| 1.00 | -3.01 | 270 | 1.005 |
| 1.20 | -0.46 | 209 | 0.660 |
| 1.40 | -0.08 | 172 | 0.417 |
| 1.60 | -0.02 | 147 | 0.291 |
| 1.80 | -0.00 | 128 | 0.219 |
| 2.00 | -0.00 | 115 | 0.171 |
| 2.50 | -0.00 | 90.4 | 0.105 |
| 3.00 | -0.00 | 74.8 | 0.071 |
| 4.00 | 0.00 | 55.8 | 0.039 |
| 5.00 | 0.00 | 44.5 | 0.025 |
| 6.00 | 0.00 | 37.0 | 0.017 |
| 7.00 | 0.00 | 31.7 | 0.013 |
| 8.00 | 0.00 | 27.7 | 0.010 |
| 9.00 | 0.00 | 24.6 | 0.008 |
| 10.0 | 0.00 | 22.2 | 0.006 |

Frequency Response

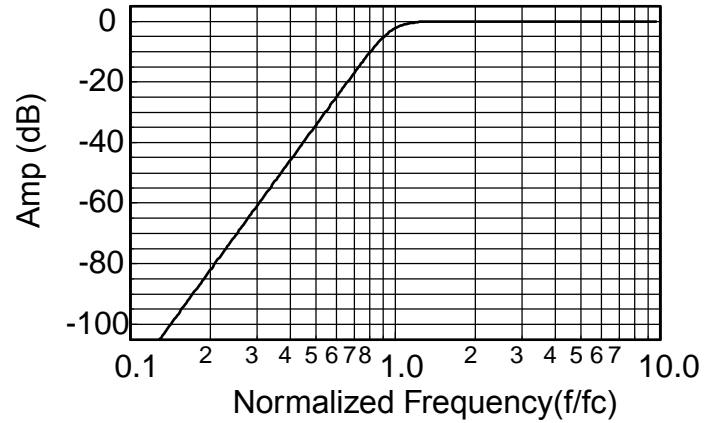

1. Normalized Group Delay:

The above delay data is normalized to a corner frequency of 1.0Hz. The actual delay is the normalized delay divided by the actual corner frequency (fc).

$$\text{Actual Delay} = \frac{\text{Normalized Delay}}{\text{Actual Corner Frequency (fc) in Hz}}$$