

INTRODUCTION

The KS58006 is DTMF/PULSE switchable dialer with a 32-digit redial which can be done using a slide switch. All necessary dual-tone frequencies are derived from a 3.579545 MHz TV crystal or ceramic resonator providing very high accuracy and stability. The required sinusoidal wave form for each individual tone is digitally synthesized on the chip. The generated wave form has very low total harmonic distortion (7% max). A voltage reference is generated on the chip which is stable over the operating voltage and temperature range and regulates the single levels of the dual tone to meet telephone industry specifications. CMOS technology is applied to this device, for very low power requirements high noise immunity, and easy interface to a variety of telephones requiring external components.

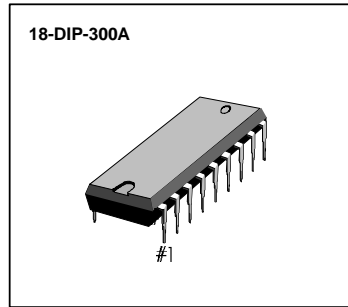

FEATURES

- Tone/Pulse switchable (slide switch)
- 32-digit capacity for redial
- Automatic mix redialing (last number dial) of PULSE → DTMF with multiple auto access pause
- PABX auto-pause for 3.5 sec.
- 4 X 4 or (2 of 8) keyboard available
- Two key single tone operation
- Operating Voltage : 2.0 ~ 5.5V
- Numbers dialed manually after redial are cascadable and stored as additional numbers for next redialing
- Uses inexpensive TV crystal or ceramic resonator (3.579545MHz)
- Make/Break ratio (33.3 / 66.6) pin selectable
- Touch key hooking (604ms)
- Low standby current
- Improved EMI characteristic
- Improved redial memory quality

ORDERING INFORMATION

Device	Package	Operating Temperature
KS58006N	18-DIP-300A	- 20°C ~ + 70°C

PIN CONFIGURATION

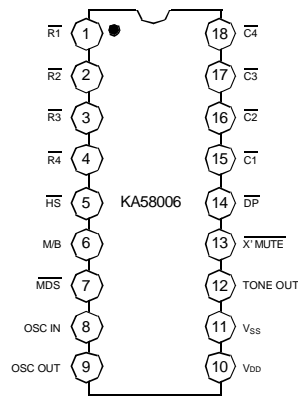

Fig. 1



BLOCK DIAGRAM

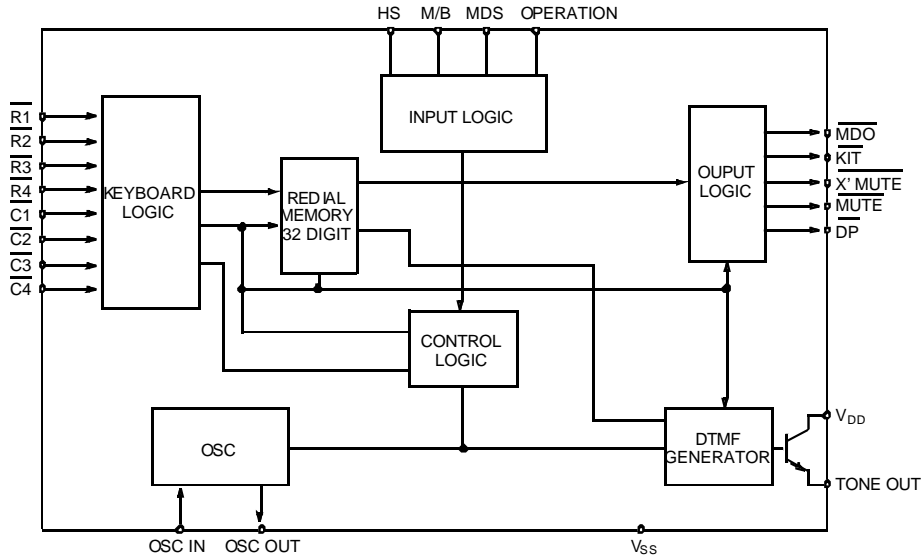
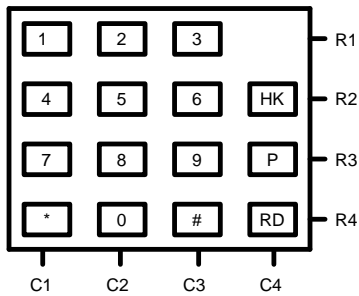

Fig. 2

ARRANGEMENT OF KEYBOARD



TONE FREQUENCIES

Input	Specified	Actual	% Error
R1	697	699.1	+ 0.31
R2	770	766.2	- 0.49
R3	852	847.4	- 0.54
R4	941	948.0	+ 0.74
C1	1209	1215.7	+ 0.57
C2	1336	1331.7	- 0.32
C3	1477	1471.9	- 0.35

* KEYBOARD DESCRIPTION

- HK : HOOKING (604ms)
- P : PAUSE (3.5 second)
- RD : REDIAL



PIN DESCRIPTION

Pin No	Symbol	Description									
1 - 4 15 - 18	$\overline{R1} - \overline{R4}$ $\overline{C1} - \overline{C4}$	Keyboard ($\overline{R1}$, $\overline{R2}$, $\overline{R3}$, $\overline{R4}$, $\overline{C1}$, $\overline{C2}$, $\overline{C3}$, $\overline{C4}$) These inputs can be interfaced to an XY matrix keyboard. $\overline{C1} - \overline{C4}$ & $\overline{R1} - \overline{R4}$ are set to low at On Hook ($\overline{HS} = \text{high}$). $\overline{C1} - \overline{C4}$ key inputs are set to low and $\overline{R1} - \overline{R4}$ are set to high at OFF HOOK ($\overline{HS} = \text{low}$) which enables the key-input operation. The oscillator starts running when a keypress is detected. Scanning signals are presented at both column and row inputs (TYP : 437Hz) until the input key is released. Key inputs are compatible with standard 2-of-8 form or single-contact keyboard. Debouncing is provided to avoid false entry (TYP : 4mS).									
5	\overline{HS}	Hook Switch This input detects the state of the hook switch contact. "Off Hook" corresponds to V_{SS} condition. "On Hook" corresponds to V_{DD} condition.									
6	M/B	Make/Break Ratio This input provides the selection of the Make/Break ratio (33.3: 66.6/40:60) when M/B is connected to V_{DD}/V_{SS} .									
7	\overline{MDS}	Mode Select Input Pulse/DTMF mode is selected as shown in the following table. Initial Mode means the state after going Off Hook ($\overline{HS} \rightarrow "V_{SS}"$) <table border="1" style="margin-left: auto; margin-right: auto;"> <thead> <tr> <th>\overline{MDS}</th> <th>INITIAL MODE</th> <th>SWITCHING ENTRY MODE</th> </tr> </thead> <tbody> <tr> <td>V_{DD}</td> <td>Pulse</td> <td>\overline{MDS} Input = V_{SS}</td> </tr> <tr> <td>V_{SS}</td> <td>Tone</td> <td>N/A</td> </tr> </tbody> </table>	\overline{MDS}	INITIAL MODE	SWITCHING ENTRY MODE	V_{DD}	Pulse	\overline{MDS} Input = V_{SS}	V_{SS}	Tone	N/A
\overline{MDS}	INITIAL MODE	SWITCHING ENTRY MODE									
V_{DD}	Pulse	\overline{MDS} Input = V_{SS}									
V_{SS}	Tone	N/A									
8 - 9	OSC IN OSC OUT	Oscillator Input/Output These pins are provided to connect an external 3.58MHz crystal. Oscillator starts (at Off Hook) and is sustained until pulse or DTMF signals are finished.									
10 - 11	V_{DD} , V_{SS}	Power These are the power supply inputs. The device is designed to be operated on 2.0V to 5.5V									
12	TONE OUT	DTMF Signal Output When a valid keypress is detected in DTMF mode, appropriate low and high group frequencies are generated which hybrid the Dual Tone Output. Tone out is Off State in pulse mode.									
13	$\overline{X'MUTE}$	$\overline{X'MUTE}$ Output <table border="1" style="margin-left: auto; margin-right: auto;"> <thead> <tr> <th>\overline{HS}</th> <th>$\overline{X'MUTE}$ Output</th> </tr> </thead> <tbody> <tr> <td>V_{DD}</td> <td>"ON"</td> </tr> <tr> <td>V_{SS}</td> <td>Normally "OFF" "ON" during pulse and DTMF dialing</td> </tr> </tbody> </table> (N channel open drain)	\overline{HS}	$\overline{X'MUTE}$ Output	V_{DD}	"ON"	V_{SS}	Normally "OFF" "ON" during pulse and DTMF dialing			
\overline{HS}	$\overline{X'MUTE}$ Output										
V_{DD}	"ON"										
V_{SS}	Normally "OFF" "ON" during pulse and DTMF dialing										
14	\overline{DP}	Dial Pulse Out \overline{DP} : The normal output will be "ON" during break and "OFF" during make at "OFF HOOK". The output will be "OFF" at "ON HOOK".									



ABSOLUTE MAXIMUM RATINGS

Characteristic	Symbol	Value	Unit
Supply Voltage	V_{DD}	6.0	V
Input Voltage	V_I	$V_{SS} - 0.3, V_{DD} + 0.3$	V
Output Voltage	V_O	$V_{SS} - 0.3, V_{DD} + 0.3$	V
Output Voltage	$V_{O(DXM)}$	$\leq V_{DD} (\overline{DP}, \overline{X'MUTE}, \overline{MUTE})$	V
Tone Output Current	$I_{O(TONE)}$	50	mA
Power Dissipation	P_D	500	mW
Operating Temperature	T_{OPR}	-20 ~ +70	°C
Storage Temperature	T_{STG}	-40 ~ +125	°C

ELECTRICAL CHARACTERISTICS

($V_{SS} = 0V, V_{DD} = 3.5V, f_{XTAL} = 3.579545MHz, T_a = 25^\circ C$, unless otherwise noted)

Characteristic	Symbol	Test Conditions	Min	Typ	Max	Unit	
Operating Voltage Range	V_{DD}		2.0		5.5	V	
Memory Retention Voltage	V_{MR}		1.0			V	
Memory Retention Current	I_{MR}	$HS = V_{DD} = 1.0V$		0.05	0.1	μA	
Operating Current	$I_{DD(PULSE)}$	$\overline{MDS} = V_{DD}$	One key selected $HS = V_{SS}$, All outputs Unloaded	0.1	0.3	mA	
	$I_{DD(TONE)}$	$\overline{MDS} = V_{SS}$		0.4	0.7		
Standby Current	I_{SB}	$\overline{HS} = V_{SS}$	No key selected. All outputs unloaded	10	50	μA	
Output Current	I_{OL1}	$\overline{DP},$	$V_{OL} = 0.4V$	$V_{DD} = 3.5V$	1.7	5.0	mA
	I_{OL2}	$\overline{X'MUTE}$		$V_{DD} = 2.5V$	0.5	1.5	
Input Voltage	V_{IH}	R1-R4, C1-C3, HS, M/B \overline{MDS}		$0.8V_{DD}$		V_{DD}	V
	V_{IL}			V_{SS}	$0.2V_{DD}$		
Input Current	I_{L1}	$V_{DD} = 3.5V, V_{IN} = 0V$	R1-R4			50	μA
	I_{L2}	$V_{DD} = 2.5V, V_{IN} = 0V$				30	
Valid Key Entry Time	t_{KD}			23		mS	
Key Release Time	t_{KR}			5		mS	
Tone Duration	t_{TD}			110		mS	
Tone Interdigit Pause Time	t_{TIDP}			110		mS	
Column and Row Scanning Frequency	f_{CR}			437		Hz	
Auto Access Pause Time	t_{AP}			3.5		sec	
Tone Output	$V_{O(TONE)}$	ROW TONE ONLY	$V_{DD} = 2.5V, R_L = 5K\Omega$	-14.0		-12.0	dBV
			$V_{DD} = 3.5V, R_L = 5K\Omega$	-14.0		-12.0	
Ratio of Column to Row Tone	dB_{CR}	$V_{DD} = 3.5V$	1.0	2.0	3.0	dB	
Distortion	THD	$V_{DD} = 3.5V$			7	%	
Tone Output Delay Time	$t_{D(TONE)}$			1.5		mS	



APPLICATION INFORMATION

KEYBOARD OPERATION

1. SINGLE MODE OPERATION

Pulse Mode Operation



The pulse mode is defined by the initial mode after going off Hook and latched at **D1** key entry. This is the condition under $MDS = V_{DD}$.

Tone Mode Operation



The tone mode is defined by the initial mode after going off Hook and latched at **D1** key entry. This is the condition under $MDS = V_{SS}$.

Manual Dialing with Automatic Access Pause



Multiple Pause key entries can be accepted and stored in the redial memory, each as a digit. Each **P** key provides 3.5 seconds pause time, but the P key entry as the first digit after going Off Hook is ignored. The ***** key can also be used as a pause key in the pulse mode. Pause (2) can be cancelled with the **P** or **RD** key during pause time in redialing.

D = Any numeric key.

Redialing

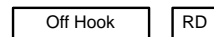

Up to 32 digits can be dialed with the **RD** key. The **RD** key is disabled while pulse or DTMF signals are transmitted. When more than 32 digits are stored, redial is also inhibited. The **#** key can be used as the **RD** key in the pulse mode.

Inhibiting Redial

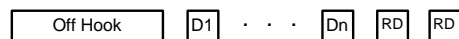

Redial can be inhibited by depressing the **RD** key twice after DTMF or pulse signals are transmitted.



2. PULSE/TONE SWITCHABLE OPERATION

Mode Switching by $\overline{\text{MDS}}$ Input

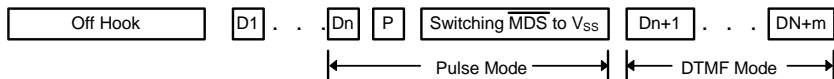

The pulse mode is initially defined $\overline{\text{MDS}} = V_{\text{DD}}$, mode switching to the DTMF mode can be accepted by $\overline{\text{MDS}} = V_{\text{SS}}$, the DTMF mode will be set up after the pulse mode is finished. In this mode, digits $D_n + 1 \dots D_n + m$ are transmitted from Tone Out as DTMF signals by depressing the corresponding keys.

If no P key is contained serially before or after mode switching, the following condition is obtained.

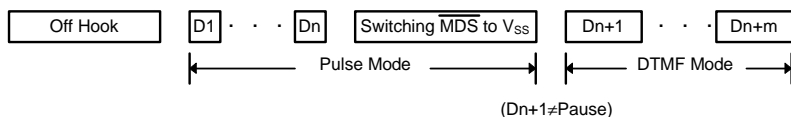

If digit D_{n+1} is depressed after the pulse mode is finished, the DTMF mode will be set up after last the pulse signal (D_n) is generated. In this mode, digits $D_{n+1} \dots D_{n+m}$ are transmitted from Tone Out as DTMF signals by depressing the corresponding keys. If digit D_{n+1} is depressed during dialing pulse signals. What happens? When the DTMF mode is set, the Hold State will be set after last pulse signal D_n is finished. $\overline{\text{MDO}}$ will flash to indicate this Hold State, $D_{n+1} \dots D_{n+m}$ are stored in redial memory as DTMF DATA and not transmitted from Tone Out. When it is ready to transmit DTMF data in redial memory, the $\overline{\text{RD}}$ or $\overline{\text{P}}$ key is depressed to reset this Hold State and $D_{n+1} \dots D_{n+m}$ data are serially transmitted.

TONE MODE TIMING ($\overline{\text{MDS}} = V_{SS}$)

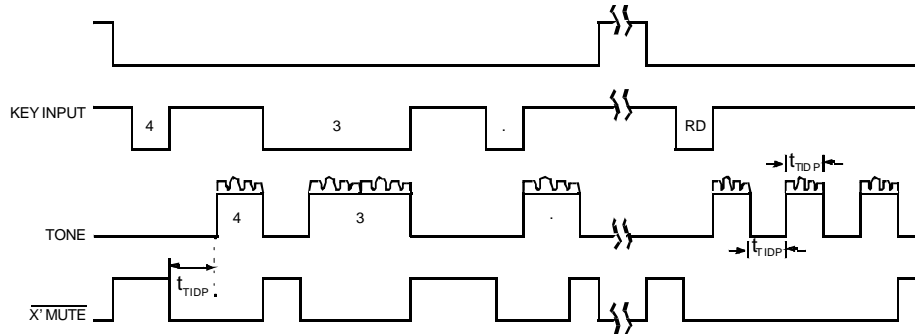

Fig. 3

PULSE MODE TIMING ($\overline{\text{MDS}} = V_{DD}$)

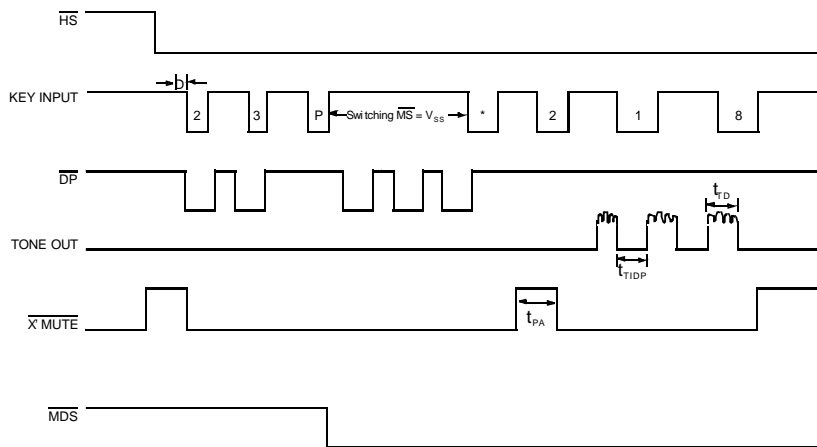

Fig. 4



TIMING DIAGRAM (for Switching Mode Operation by $\overline{\text{MDS}}$ Input)

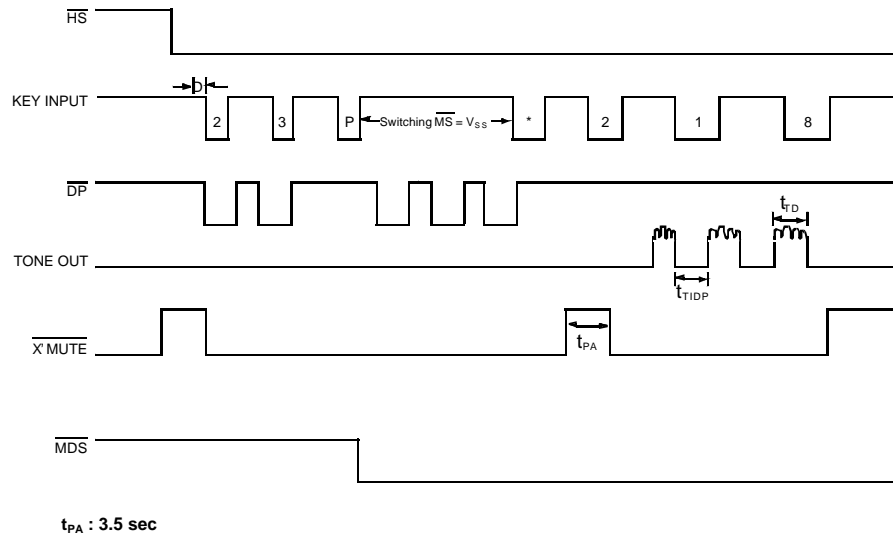

Fig. 5

