

PEAK

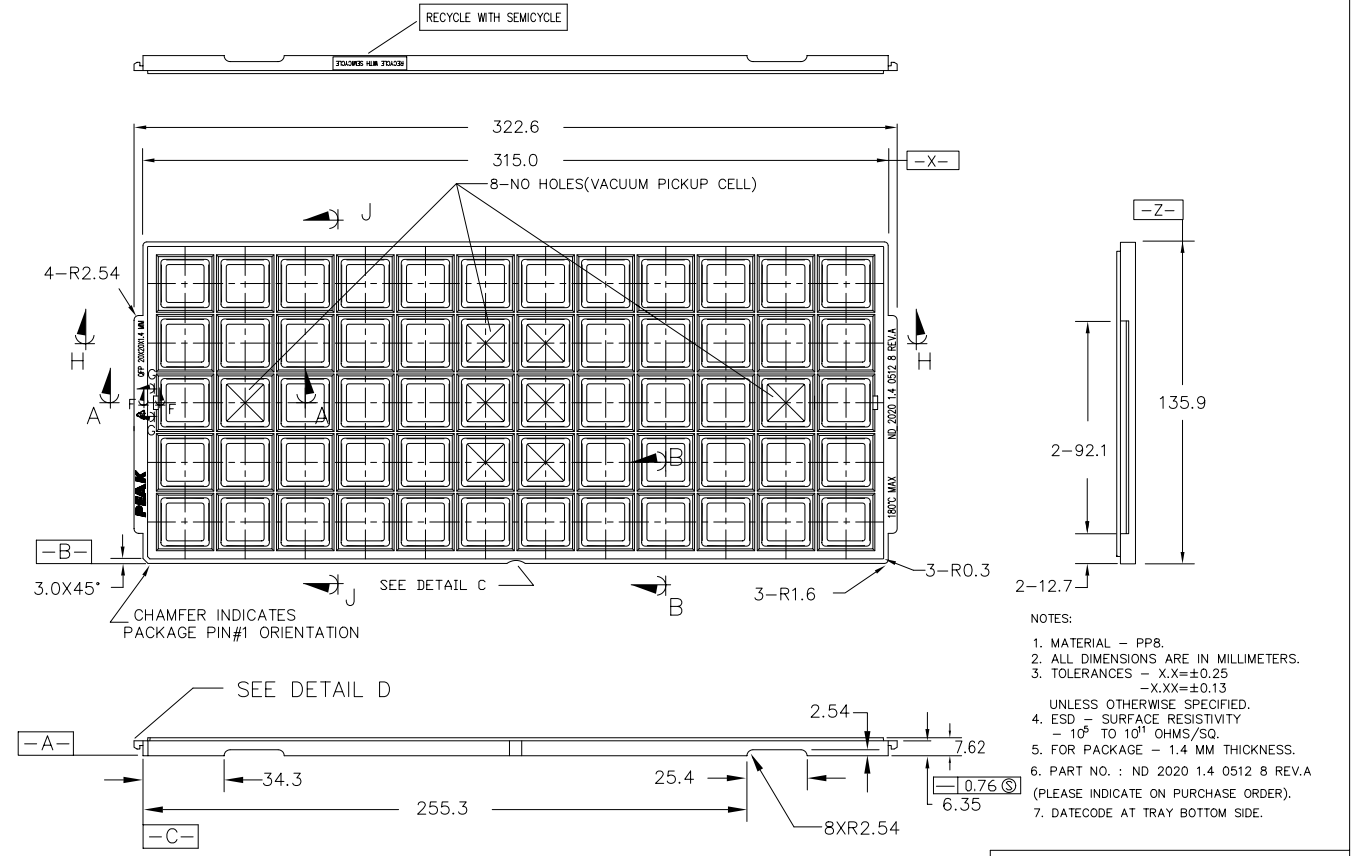

PEAK PEAK PLASTIC & METAL PRODUCTS INT'L LTD.

REV.NO.	ECN #	DESCRIPTION	DATE
12	P-01166	ADD RIBS AND THICKNESS OF PLASTIC ON BOTTOM SIDE	21 FEB 03
11	P-00953	CHANGE FROM TOPP TO QFP	10 AUG 99
10	P-00867	CHANGE SURFACE RESISTIVITY	1 FEB 99
9	P-00624	CHANGE POSITION TOL	25 SEP 97
8	P-00563	CHANGE TOP RIDGE INNER DIM	16 NOV 95
7	P-00557	ADD DETAIL 'S' AS MARKING	9 OCT 95

THIS DOCUMENT CONTAINS INFORMATION PROPRIETARY TO PEAK PLASTIC & METAL PRODUCTS INTERNATIONAL LIMITED. REPRODUCTION, DISCLOSURE OR USE OF THIS DOCUMENT IS EXPRESSLY PROHIBITED EXCEPT IF OTHERWISE AGREED UPON IN WRITING.

DRAWN BY :	WANG	PAGE 1 OF 2
CHECKED BY :	WILDER	DATE : 21 FEB 03
APPROVED BY :	JONES	DATE : 21 FEB 03
APPROVED BY :	DAVY	DATE : 21 FEB 03
DO NOT SCALE DRAWING		CODE : CSA00642

CUSTOMER : **PEAK**

TITLE : ND 2020 1.4 0512 8 REV.A

DWG NO. : ND 2020 1.4 0512 8 REV.A

REV. 12

PEAK

SECTION A-A

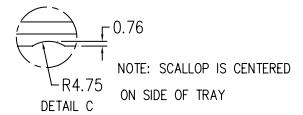
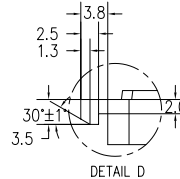
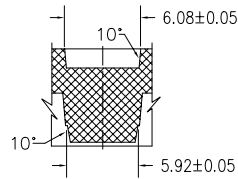
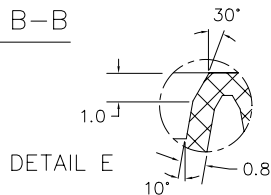
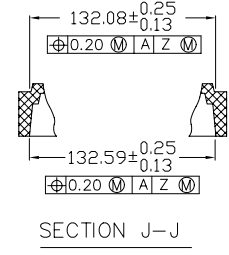
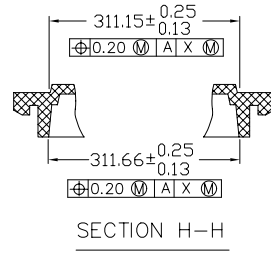
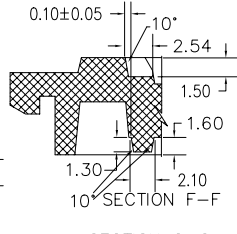
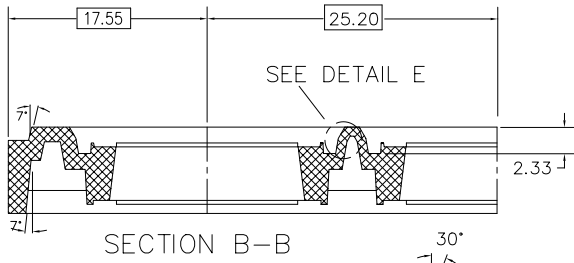
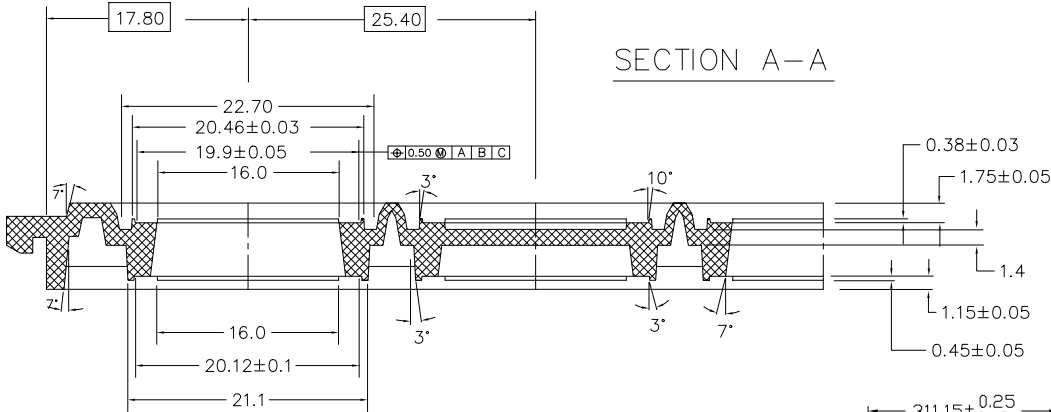

REV. NO.	ECN #	DESCRIPTION	DATE
12	P-01166	ADD RIBS AND THICKNESS OF PLASTIC ON BOTTOM SIDE	21 FEB 03
11	P-00953	CHANGE FROM TOFP TO QFP	10 AUG 99
10	P-00867	CHANGE SURFACE RESISTIVITY	1 FEB 99
9	P-00624	CHANGE POSITION TOL	25 SEP 97
8	P-00563	CHANGE TOP RIDGE INNER DIM	16 NOV 95
7	P-00557	ADD DETAIL 'S' AS MARKING	9 OCT 95

THIS DOCUMENT CONTAINS INFORMATION PROPRIETARY TO PEAK PLASTIC & METAL PRODUCTS INTERNATIONAL LIMITED. REPRODUCTION, DISCLOSURE OR USE OF THIS DOCUMENT IS EXPRESSLY PROHIBITED EXCEPT IF OTHERWISE AGREED UPON IN WRITING.

DRAWN BY :	WANG	PAGE 2 OF 2
CHECKED BY :	WILDER	DATE : 21 FEB 03
APPROVED BY :	JONES	DATE : 21 FEB 03
APPROVED BY :	DAVY	DATE : 21 FEB 03
DO NOT SCALE DRAWING		CODE : CSA00642

	PEAK PLASTIC & METAL PRODUCTS INT'L LTD.
CUSTOMER :	PEAK
TITLE :	ND 2020 1.4 0512 8 REV.A
DWG NO. :	ND 2020 1.4 0512 8 REV.A
REV. 12	