

1.1GHz 2 Modulus Prescaler for Cellular Equipment

Description

The CXA1541M is a 1.1GHz 2 modulus prescaler developed for cellular equipment use. A low current consumption of 3.5mA and small package makes it most suitable for lowering power consumption and increasing the compactness of equipments.

Features

- Ultra-low power consumption (3.5mA at $V_{CC} = 5.0V$)
- Rated maximum operating frequency provided at 1.1GHz
- Selection of 64/65 and 128/129 frequency dividers

Applications

1 GHz band radio communications of cellular equipment

Structure

Bipolar silicon monolithic IC



Absolute Maximum Ratings

- Supply voltage V_{CC} 7.0 V
- Operating temperature T_{OPR} -35 to +85 °C
- Storage temperature T_{STG} -65 to +150 °C
- Allowable power dissipation P_D 300 mW

Operating Conditions

- Supply voltage V_{CC} 4.5 to 5.5 V

Block Diagram and Pin Configuration

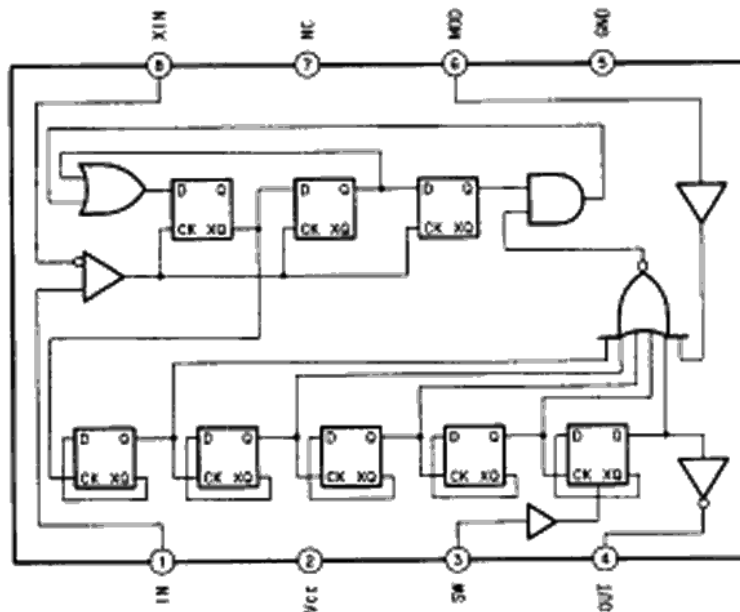

Pin Description

Pin No.	Symbol	Reference pin voltage (DC)	Equivalent circuit	Description
1	IN	2.2V		<p>Input for signal frequency to be divided. Differential input is used as indicated by equivalent circuit. For single ended input, connect a capacitor to one of the input pins.</p>
8	XIN	2.2V		
2	V _{cc}	5.0V		V _{cc}
3	SW	(Open "L")		<p>Switchover for the frequency divider value (Refer to the Description of Operation)</p>
4	OUT	3.6V		<p>Output for frequency divided signal</p>
5	GND	0V		GND
6	MOD	(Open "L")		<p>Switchover for the divider value (Refer to the Description of Operation)</p>
7	NC	—		No connection

Electrical Characteristics

(Refer to Electrical Characteristics Test Circuit, $V_{CC}=4.5V$ to $5.5V$, $T_a=-35^{\circ}C$ to $85^{\circ}C$, $C_L=2pF$)

No.	Item	Symbol	Test condition	Test point	Min.	Typ.	Max.	Unit
1	Supply current	I_{CC}	$f_{in}=1.1GHz$ $P_{in}=-10dBm$ MOD, SW="H"	1cc		3.5	5.0	mA
2	Output amplitude	V_{OUT}	$f_{in}=1.1GHz$ $P_{in}=-10dBm$	4pin	1.0	1.5		Vp-p
3	Response input frequency	f_{in}		4pin	0.8		1.1	GHz
4	Allowable input level	P_{in}		1pin	-10		0	dBm
5	"High" level voltage	MOD input	V_{IH}	6pin	2.0			V
	"Low" level voltage		V_{IL}	6pin			0.8	V
6	"High" level voltage	SW input	V_{IH}	3pin	$V_{CC}-0.1$	V_{CC}	$V_{CC}+0.1$	V
	"Low" level voltage		V_{IL}	3pin	-0.1	0	+0.1	V
7	"High" level current	MOD input	I_{IH}	$V_{IH}=V_{CC}$	16		400	μA
	"Low" level current		I_{IL}	$V_{IL}=0V$	16	-200		μA
8	"High" level current	SW input	I_{IH}	$V_{IH}=V_{CC}$	13		100	μA
	"Low" level current		I_{IL}	$V_{IL}=0V$	13	-10		μA
9	Module setup time	t_{SET}	$f_{in}=1.1GHz$ $P_{in}=-10dBm$	4pin		17	26	ns

Electrical Characteristics Test Circuit

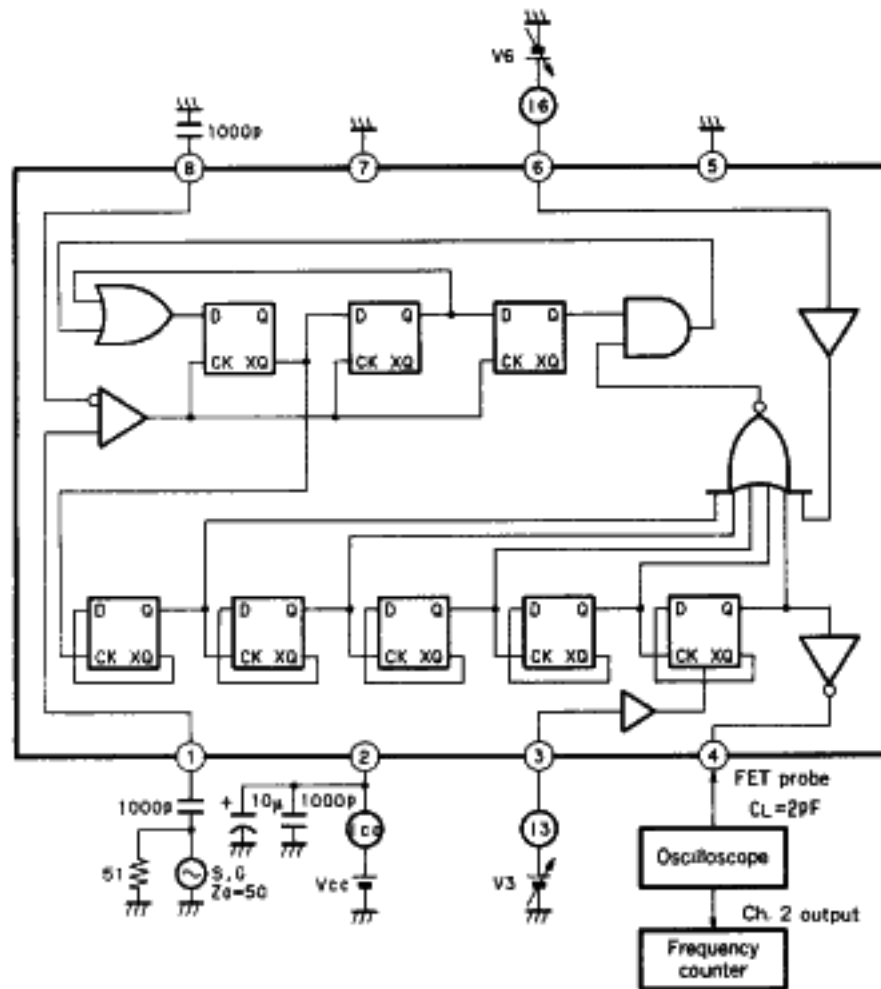

Description of Operation

The table below gives the divider value settings.

SW	MOD	Divider
H	H	64
	L	65
L	H	128
	L	129

The IN and XIN pins serve as inputs for the VCO oscillator signal. A differential input is used for input signals. For single-ended input the XIN pin should be grounded through a capacitor (a 1000pF capacitor is recommended) and the IN pin used for signal input. The signal input to the IN pin is divided by a pre-set divider value and output to the OUT pin. The divider value is pre-set as follows. The SW pin is used to

determine whether a 64/65 or a 128/129 divider is to be used. This pin is usually connected to either V_{CC} or GND. The MOD pin is used to select divider values between 64 and 65 or between 128 and 129. This MOD pin should be connected to the modulus controller output pin of the PLL frequency synthesizer IC. The rising and falling edges of the signal input to the MOD pin must be fast enough to provide the necessary time for module set-up. This IC synchronizes the output of a modulus controller with the falling edge of a comparator/divider and outputs the resultant signal to a PLL frequency synthesizer.

Timing Chart (For 2 modulus, 64/65 divider)

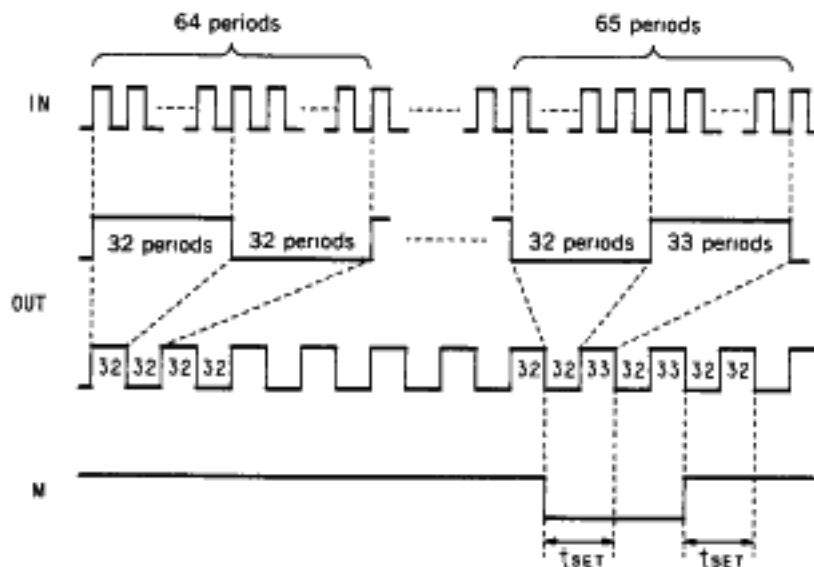

- When an extra cycle (65th cycle) occurs, the input signal is increased by one at the "High" to "Low" falling edge of the 1st period.

Application Circuit

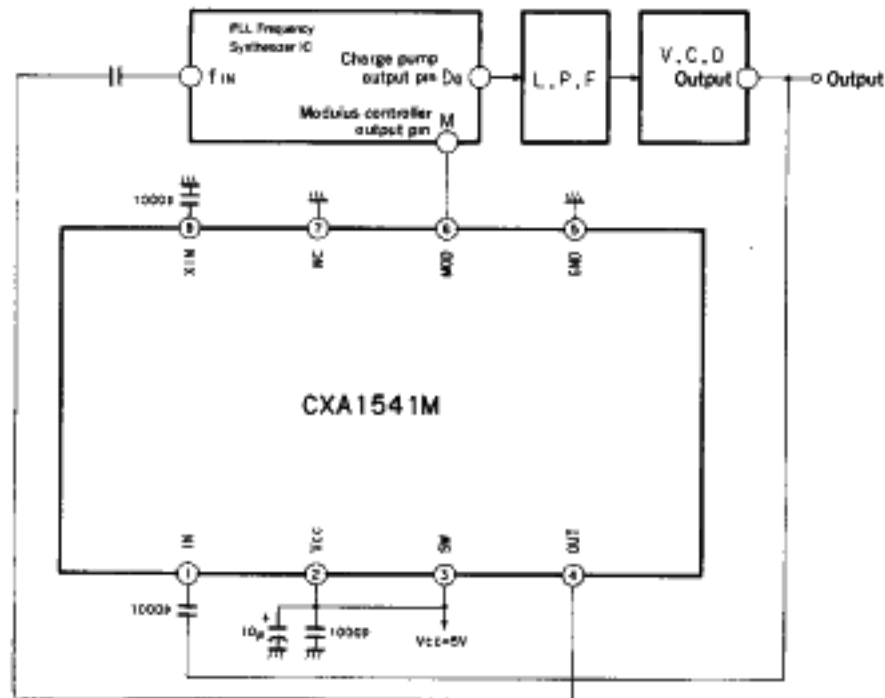

The CXA1541M is capable of functioning as PLL frequency synthesizer when configured with PLL synthesizer IC with 2 modulus prescaler controller, low pass filter, and voltage control oscillator. (This IC operates as a 64/65 divider at the above circuit.)

Notes on Operation

- Pins 1 and 8 process high frequency signals requiring the CXA1541 to use smaller protective elements than a conventional IC. Therefore, its tolerance to static electricity is poor.
- The MOD pin is an input pin for switching divider values. An unstable input may cause a longer module set-up time or an incorrect divider value to be pre-set. A signal with a fast transition time of rise and fall time should be input to ensure smooth operation.
- A short lead should be used to connect the grounding capacitor to V_{CC} due to the high frequencies processed
- The drive capability of the CXA1541 has been minimized in order to reduce current consumption. Therefore Load capacitor must be less than 2pF.

Characteristic Graphs

Input Signal Level vs. Operating Frequency Characteristics 1 $V_{CC}=5V$

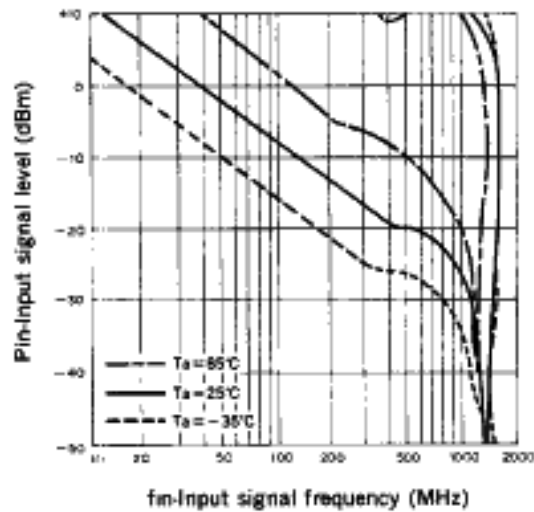

Input Signal Level vs. Operating Frequency Characteristics 2 $T_a=25^\circ C$

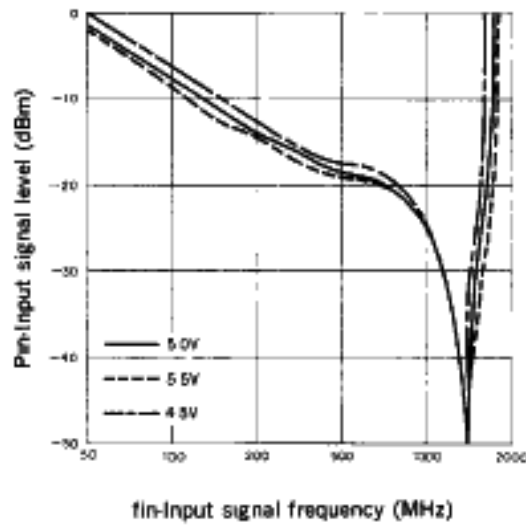

Supply current vs. Supply voltage ($SW=MOD= \text{"High"} , T_a=25^\circ C$)

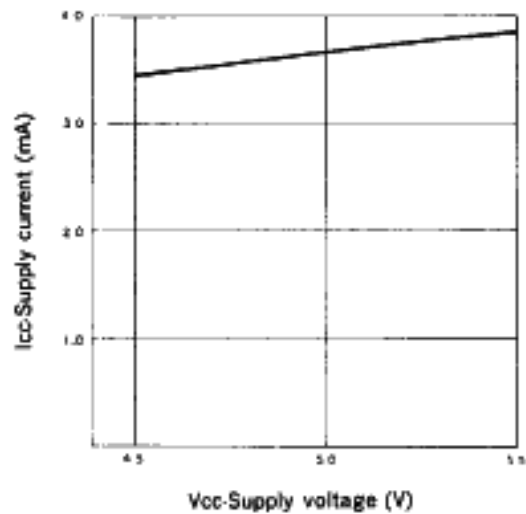

Supply current vs. temperature ($V_{CC}=5V, SW, MOD$ supply current included)

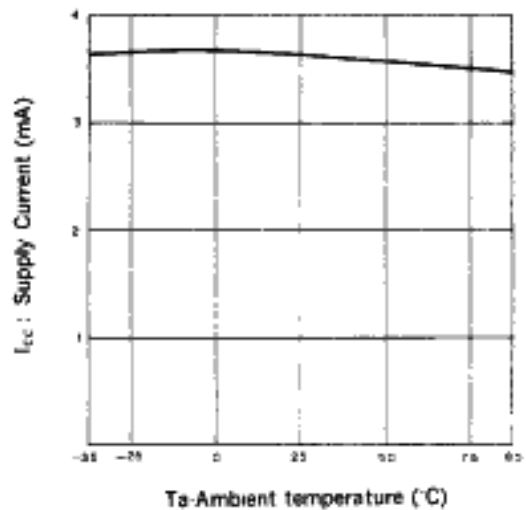

Set up time vs. temperature ($V_{CC}=5V$)

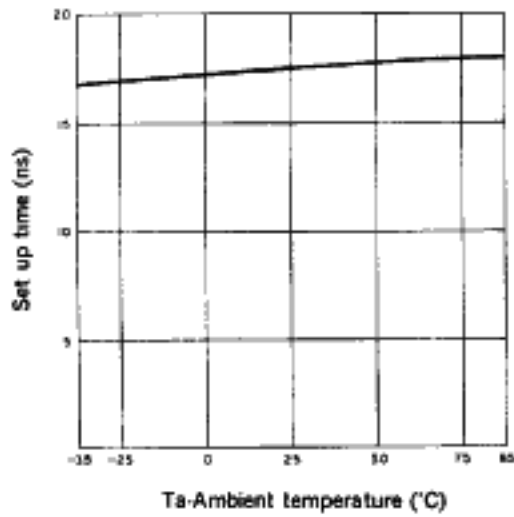

Package Outline Unit: mm



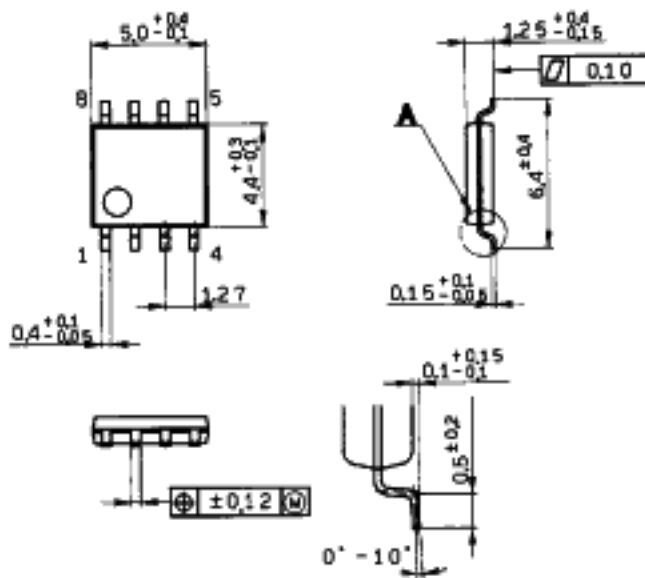











8pin SOP (Plastic) 225mil



Detailed diagram of A

SONY NAME	SOP-8P-L03
EIAJ NAME	*SOP008-P-0225-A
JEDEC CODE	—

Package Name

Type	Package name		Package	Features				
	Symbol	Description		Mount	Lead pitch	Lead shape	Lead pull out direction	
Inserted	Standard	DIP	DUAL IN-LINE PACKAGE		P C	2.54mm (100MIL)	Through Hole Lead	2-direction
		SIP	SINGLE IN-LINE PACKAGE		P	2.54mm (100MIL)	Through Hole Lead	1-direction
		ZIP	ZIG ZAG IN-LINE PACKAGE		P	2.54mm (100MIL) Zig-Zag in-line	Through Hole Lead	1-direction
		PGA	PIN GRID ARRAY		C	2.54mm (100MIL)	Through Hole Lead	Package under side
		PGYB	PIGGY BACK		C	2.54mm (100MIL)	Through Hole Lead	2-direction
Shrink	SDIP	SHRINK DUAL IN-LINE PACKAGE		P	1.778mm (70MIL)	Through Hole Lead	2-direction	
	SZIP	SHRINK ZIG-ZAG IN-LINE PACKAGE		P	1.778mm (70MIL) Zig-Zag in-line	Through Hole Lead	1-direction	
Surface mounted	Standard flat package	QFP	QUAD FLAT LEADED PACKAGE		P C	1.0mm 0.8mm 0.65mm	Gull-Wing	4-direction
		SOP	SMALL OUTLINE LEADED PACKAGE		P	1.27mm (50MIL)	Gull-Wing	2-direction
	Standard 2-direction chip carrier	SOJ	SMALL OUTLINE J-LEADED PACKAGE		P	1.27mm (50MIL)	J-Lead	2-direction
	Shrink flat package	VQFP	VERY SMALL QUAD FLAT PACKAGE		P	0.5mm	Gull-Wing	4-direction
		VSOP	VERY SMALL OUTLINE PACKAGE		P	0.65mm	Gull-Wing	2-direction
		TSOP	THIN SMALL OUTLINE PACKAGE		P	0.5mm (0.55mm)	Gull-Wing	2-direction
	Standard chip carrier	QFJ	QUAD FLAT J-LEADED PACKAGE		P	1.27mm (50MIL)	J-Lead	4-direction
		QFN	QUAD FLAT NON-LEADED PACKAGE		C	1.27mm (50MIL)	Leadless	Package under side

• P Plastic, C Ceramic

2