

PEAK

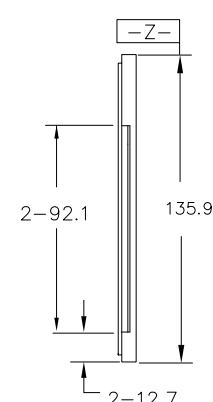

- NOTES :
1. MATERIAL - PP8.
 2. ALL DIMENSIONS ARE IN MILLIMETERS.
 3. TOLERANCES - X.X=±0.25
- X.XX=±0.13
UNLESS OTHERWISE SPECIFIED.
 4. ESD - SURFACE RESISTIVITY
- 10⁹ TO 10¹¹ OHMS/SQ.
 5. FOR PACKAGE - 1.4MM THICKNESS.
 6. PART NO. : ND 1010 1.4 0820 8 REV.A
(PLEASE INDICATE ON PURCHASE ORDER).
 7. ESD - SURFACE RESISTIVITY
10¹¹ OHMS/SQ MAX.
(APPLICABLE FOR ASE PARTS ONLY)

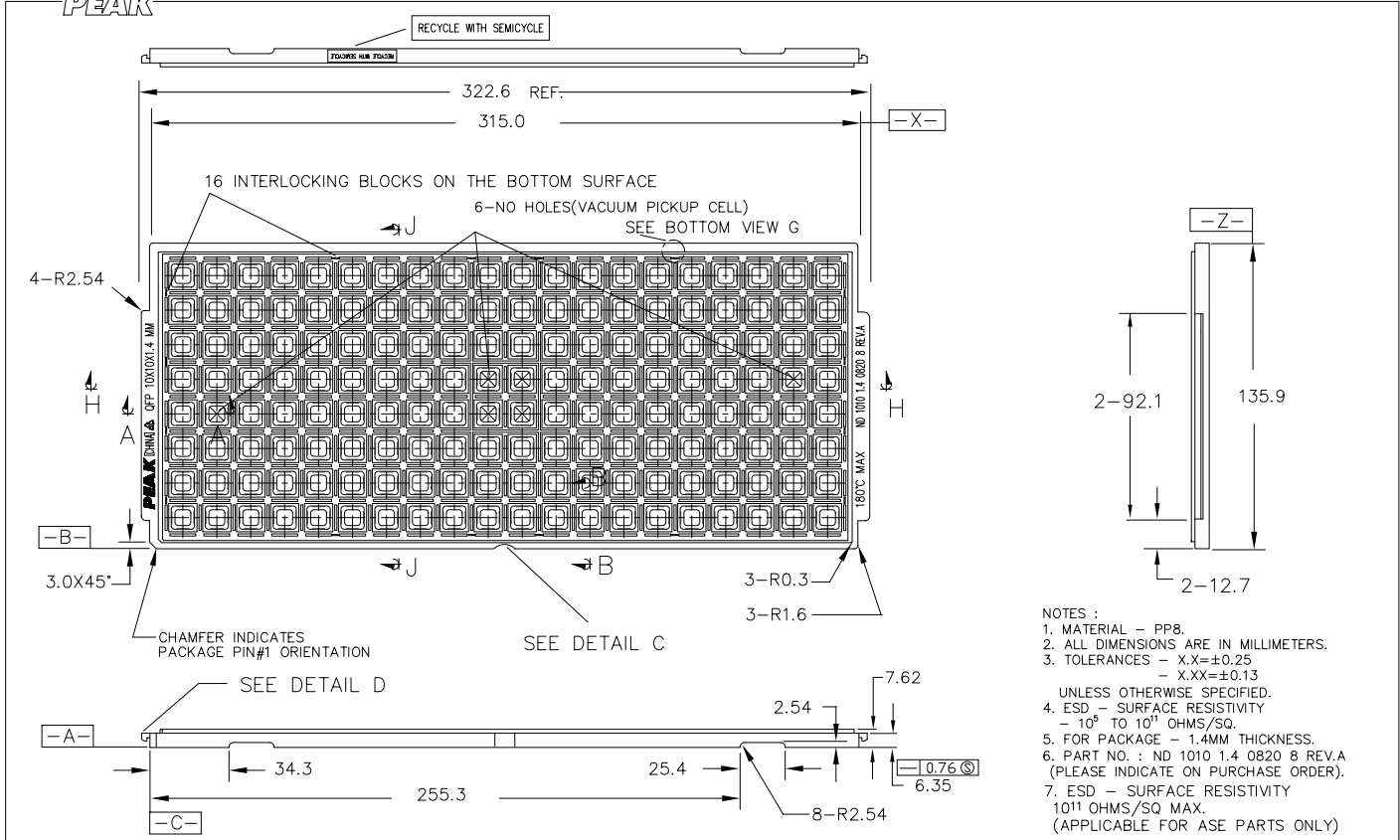

18	P-00953	CHANGE FROM TOPF TO QFP	10 AUG 99
17	P-00897	CHANGE SURFACE RESISTIVITY	2 FEB 99
16	P-00651	CANCEL COLOR REQUIREMENT	16 OCT 97
15	P-00556	ADD DETAIL S AS MARKING	15 SEP 95
14	P-00546	DELETED "ASSEMBLED IN SINGAPORE"	1 SEP 95
13	P-00461	CHANGE "LOW TEMP." TO "75°C MAX."	11 JAN 95
REV.NO.	ECH #	DESCRIPTION	DATE

THIS DOCUMENT CONTAINS INFORMATION PROPRIETARY TO PEAK PLASTIC & METAL PRODUCTS INTERNATIONAL LIMITED. REPRODUCTION, DISCLOSURE OR USE OF THIS DOCUMENT IS EXPRESSLY PROHIBITED EXCEPT IF OTHERWISE AGREED UPON IN WRITING.

DRAWN BY :	BUSH	PAGE 1 OF 2
CHECKED BY :		DATE : 10 AUG 99
APPROVED BY :		DATE : 10 AUG 99
DO NOT SCALE DRAWING		DATE : 10 AUG 99
		CODE : CSA00556

CUSTOMER :	PEAK
TITLE :	ND 1010 1.4 0820 8 REV.A
DWG NO.:	ND 1010 1.4 0820 8 REV.A
	REV. 18

PEAK

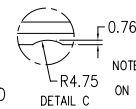
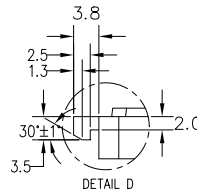
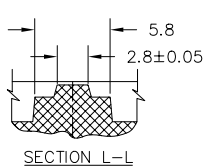
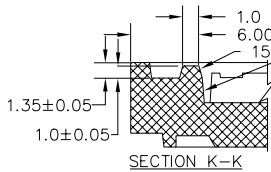
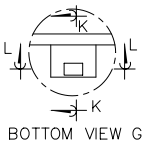
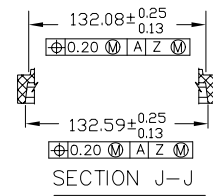
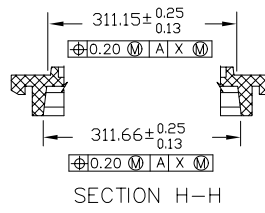
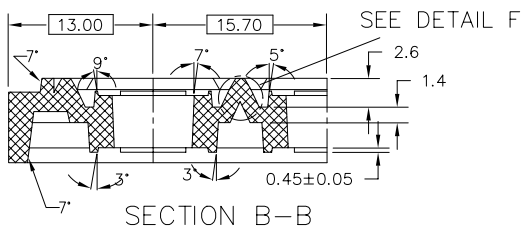
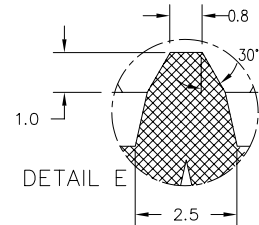
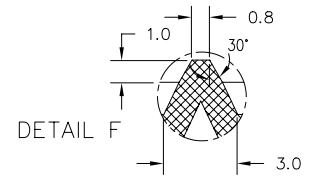
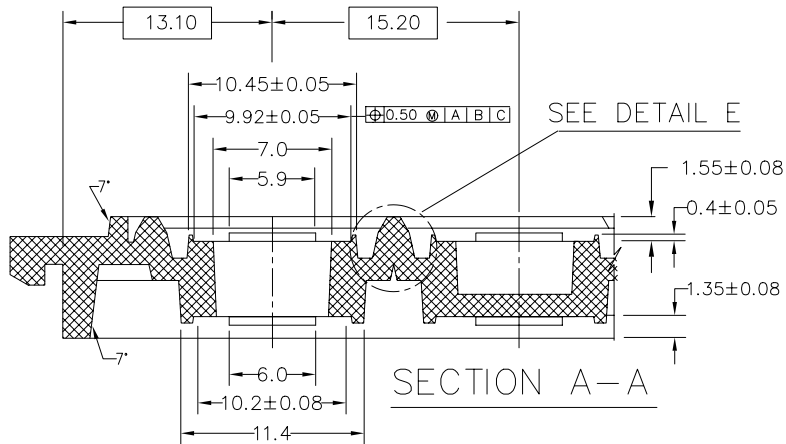

NOTE: SCALLOP IS CENTERED ON SIDE OF TRAY

PEAK PEAK PLASTIC & METAL PRODUCTS INT'L LTD.

REV.NO.	ECH #	DESCRIPTION	DATE
18	P-00953	CHANGE FROM TOPF TO QFP	10 AUG 99
17	P-00897	CHANGE SURFACE RESISTIVITY	2 FEB 99
16	P-00651	CANCEL COLOR REQUIREMENT	16 OCT 97
15	P-00556	ADD DETAIL S AS MARKING	15 SEP 95
14	P-00546	DELETED "ASSEMBLED IN SINGAPORE"	1 SEP 95
13	P-00461	CHANGE "LOW TEMP." TO "75°C MAX."	11 JAN 95

THIS DOCUMENT CONTAINS INFORMATION PROPRIETARY TO PEAK PLASTIC & METAL PRODUCTS INTERNATIONAL LIMITED. REPRODUCTION, DISCLOSURE OR USE OF THIS DOCUMENT IS EXPRESSLY PROHIBITED EXCEPT IF OTHERWISE AGREED UPON IN WRITING.

DRAWN BY :	BUSH	PAGE 2 OF 2
CHECKED BY :		DATE : 10 AUG 99
APPROVED BY :		DATE : 10 AUG 99
DO NOT SCALE DRAWING		DATE : 10 AUG 99
		CODE : CSA00556

CUSTOMER :	PEAK	
TITLE :	ND 1010 1.4 0820 8 REV.A	
DWG NO.:	ND 1010 1.4 0820 8 REV.A	REV. 18