



SANYO Semiconductors

DATA SHEET

LA1837M — Monolithic Linear IC
Single-Chip AM/FM Tuner IC for Home Stereo Systems

Overview

The LA1837M is a single-chip AM/FM tuner IC that provides AM and FM IF and multiplex decoding circuits for electronic tuning and was developed for use in home stereo systems. It provides both SD and IF counting techniques for optimal implementation of automatic station selection.

Features

- On-chip MPX VCO circuit (no external components required).
- Adjacent channel interference rejection function (third order and fifth order).
- Supports both the SD and IF counting technique (built-in SD speedup function).
- The AM and FM SD sensitivity can be set independently.
- The AM and FM output levels can be set independently.
- Improved basic FM reception performance.

Functions

- AM: RF amplifier, mixer, oscillator, IF amplifier, detector, AGC, oscillator buffer, S-meter, narrow band SD, IF buffer
- FM IF: IF amplifier, quadrature detector, S-meter, SD, S curve detection, IF buffer output
- Multiplex stereo decoding: PLL stereo decoder, stereo indicator, forced monaural, VCO stop function, post amplifier, audio muting, adjacent channel interference rejection function

Specifications

Maximum Ratings at Ta = 25°C

Parameter	Symbol	Conditions	Ratings	Unit
Maximum supply voltage	V _{CC} max		12	V
Allowable power dissipation	Pd max	Ta ≤ 70°C*	550	mW
Operating temperature	Topr		-20 to +70	°C
Storage temperature	Tstg		-40 to +125	°C

*: Mounting board: 114.3×76.1×1.6mm glass epoxy board

■ Any and all SANYO Semiconductor products described or contained herein do not have specifications that can handle applications that require extremely high levels of reliability, such as life-support systems, aircraft's control systems, or other applications whose failure can be reasonably expected to result in serious physical and/or material damage. Consult with your SANYO Semiconductor representative nearest you before using any SANYO Semiconductor products described or contained herein in such applications.

■ SANYO Semiconductor assumes no responsibility for equipment failures that result from using products at values that exceed, even momentarily, rated values (such as maximum ratings, operating condition ranges, or other parameters) listed in products specifications of any and all SANYO Semiconductor products described or contained herein.

LA1837M

Operating Conditions at $T_a = 25^\circ\text{C}$

Parameter	Symbol	Conditions	Ratings	Unit
Recommended supply voltage	V_{CC}		9	V
Operating supply voltage range	$V_{CC\text{ op}}$		7.0 to 11.0	V

Electrical Characteristics at $T_a = 25^\circ\text{C}$ $V_{CC} = 9.0\text{V}$, in the specified circuit.

Parameter	Symbol	Conditions	Ratings			Unit
			min	typ	max	
[FM Mono Characteristics] $f_c = 10.7\text{MHz}$, $f_m = 1\text{kHz}$, with the coil adjusted so that $V_{AFC} - V_{REG} = 0\text{V}$.						
Current drain	I_{CCO-FM}	No input	18	31	44	mA
Demodulator output	V_{OFM}	100dB μ , 100% mod, pin 16 output	730	1100	1460	mVrms
Channel balance	C.B-mono	100dB μ , 100% mod, pin 16 output / pin 17 output	-1.5	0	+1.5	dB
Total harmonic distortion (mono)	THDFM1	100dB μ , 100% mod, pin 16 output		0.3	1.3	%
	THDFM2	100dB μ , 200% mod, pin 16 output		1.0	5.0	%
Signal-to-noise ratio	S/N_{FM}	100dB μ , 100% mod, pin 16 output	72	80		dB
AM rejection ratio	AMR	100dB μ , AM 30% mod, pin 16 output	45	65		dB
Input limiting voltage	-3dBLS	Referenced to 100dB μ , 100% mod, the input for output is -3dB down.	26	32	38	dB μ
LED on sensitivity	SD_{ON-FM}		51	60	69	dB μ
LED on bandwidth	SD_{BW}	100dB μ	85	120	170	kHz
IF counter buffer output	$V_{IFBUFF-FM}$	100dB μ , pin 13 output	80	120	160	mVrms
S-meter output	$V_{SM\text{ FM}1}$	0dB μ , pin 11 output	0	0.1	0.5	V
	$V_{SM\text{ FM}2}$	100dB μ , pin 11 output	3.6	4.3	5.0	V
Muting attenuation	Mute Alt	100dB μ , 100% mod, the pin 16 output	75	85		dB
[FM Stereo Characteristics] $f_c = 10.7\text{MHz}$, 100dB μ , $f_m = 1\text{kHz}$, L+R = 90%, pilot = 10%						
Separation: L	SepL	Lmod. pin 16 output / pin 17 output	30	45		dB
Separation: R	SepR	Rmod. pin 17 output / pin 16 output	30	45		dB
Stereo on level	ST_{ON}	The pilot mod such that $V_7 < 0.7\text{V}$	1.3	2.7	5.0	%
Stereo off level	ST_{OFF}	The pilot mod such that $V_7 > 4.5\text{V}$		1.5		%
Total harmonic distortion (main)	THD main	L+R mod. Pin 16 output		0.3	1.3	%
Adjacent channel interference rejection ratio	Brej-3rd	$f_s = 113\text{kHz}$, $V_s = 90\%$, Pilot = 10% Pin 16 output, versus L-R mod. 1kHz demodulator output		40		dB
	Brej-5th	$f_s = 189\text{kHz}$, $V_s = 90\%$, Pilot = 10% Pin 16 output, versus L-R mod. 1kHz demodulator output		40		dB
[AM Characteristics]						
Current drain	I_{CCO-AM}	No input	15	25	35	mA
Output detector	V_{OAM1}	23dB μ , 30% mod, pin 16 output	100	180	360	mVrms
	V_{OAM2}	80dB μ , 30% mod, pin 16 output	200	320	500	mVrms
Signal-to-noise ratio	S/N_{AM1}	23dB μ , 30% mod, pin 16 output	18	22		dB
	S/N_{AM2}	80dB μ , 30% mod, pin 16 output	49	55		dB
Total harmonic distortion	THD AM 1	80dB μ , 30% mod, pin 16 output		0.4	1.2	%
	THD AM 2	80dB μ , 80% mod, pin 16 output		1.0	4.0	%
LED-ON sensitivity	SD_{On-AM}		17	27	37	dB μ
Oscillator buffer output	V_{OSC-AM}	No input, pin 30 output	110	160	220	mVrms
IF counter buffer output	$V_{IFBuff-AM}$	80dB μ , non-mod, pin 13 output	160	220	300	mVrms
ST IF output	$V_{STIF-AM}$	80dB μ , non-mod, pin 7 output	16	34	48	mVrms
S-meter output	V_{SM-AM}	0dB μ , non-mod	0	0	0.2	V

LA1837M

Package Dimensions

unit : mm
3073C

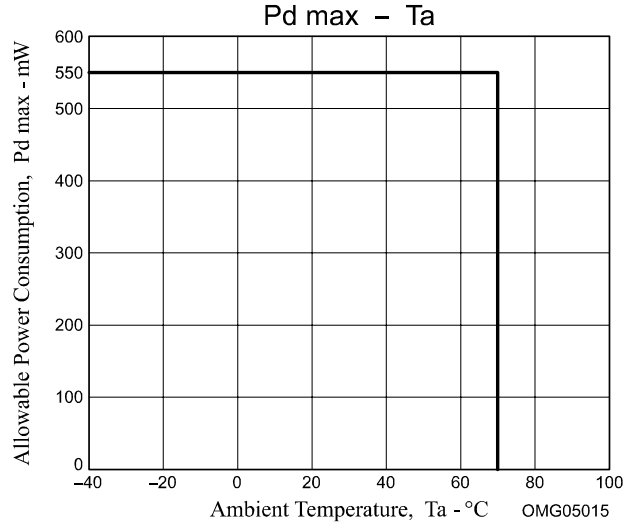
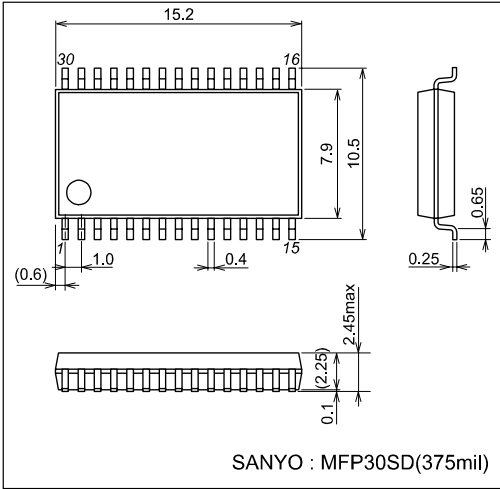

Block Diagram

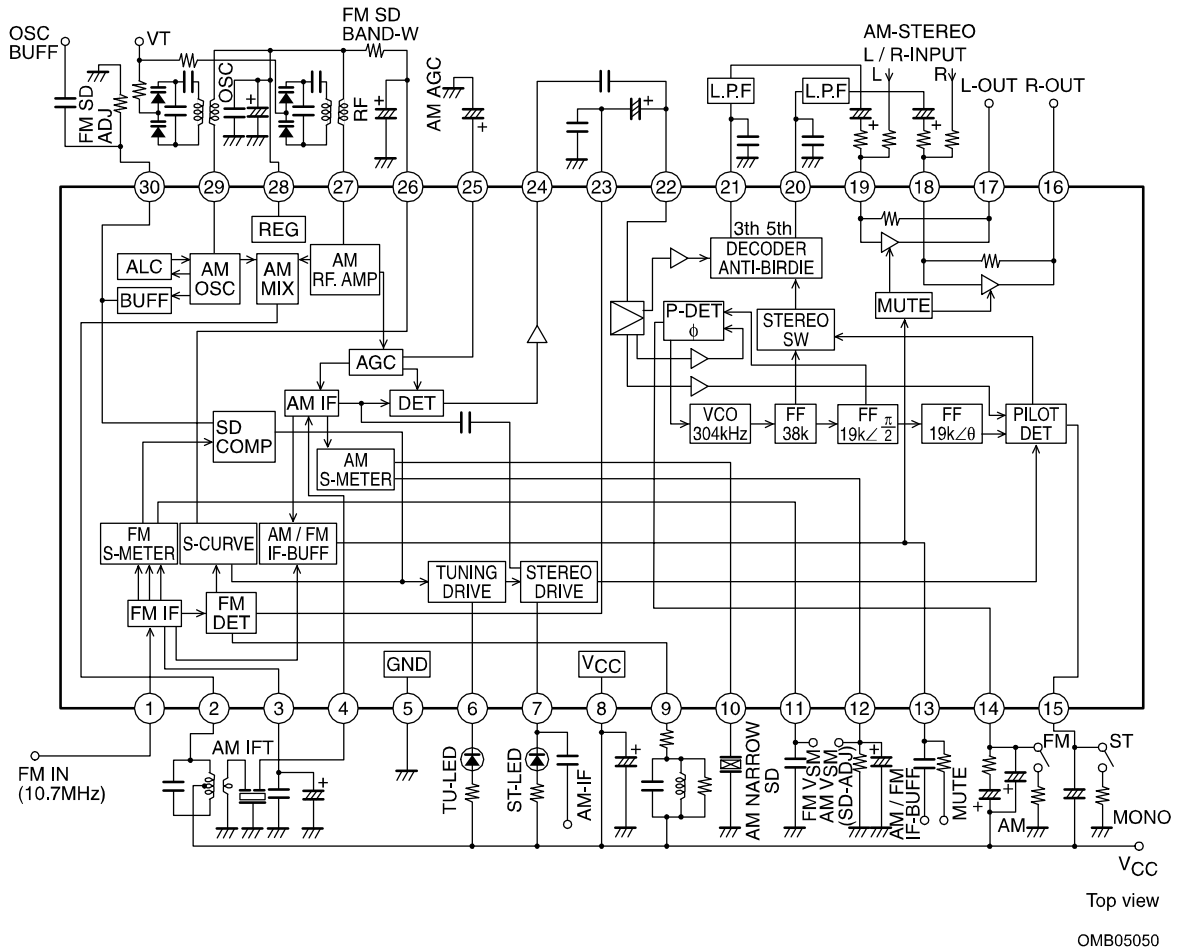

Coil Specifications

- AM oscillator (for the DUT)
HW-50425 (Mitsumi Electric Co., Ltd.)

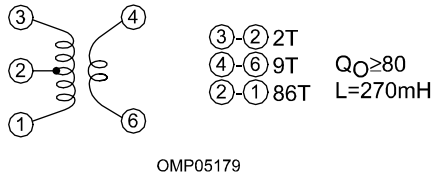

- IFT
YD-1073-1 (Mitsumi Electric Co., Ltd.)

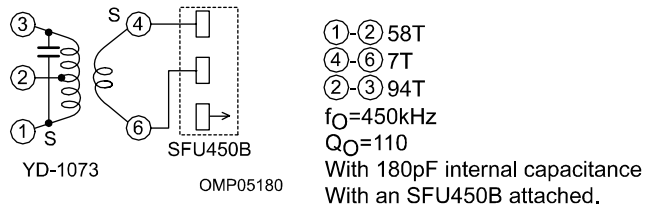

- FM-DET
600BEAS-9715Z (Toko Electric Corporation)

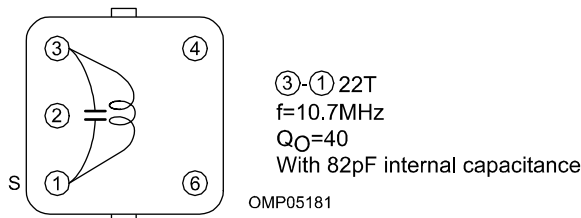

Pin Function

Pin No.	Pin	Pin voltage	Equivalent circuit	Pin function
1	FM IF input	Vreg	 OMP05156	Input impedance $r_i = 330 \Omega$
2	AM mixer output	VCC	 OMP05157	Connect the mixer coil between this pin and VCC.
3	FM IF input bypass	Vreg	See pin 1	Also used for the multiplex regulator filter
4	AM IF input	Vreg	 OMP05158	Input impedance $r_i = 2 \text{ k}\Omega$
5	GND	0V		
6	TU-LED, ST-LED, AM - IF output	VCC VCC	 OMP05159	Active low Open collector AM stereo IF output (pin 7) This pin must be set up with an influx current under 150μA.
8		VCC		
9	FM detector	VCC	 OMP05160	Recommended detector coil 600BEAS-9715Z (The Toko Electric Corporation)

Continued on next page.

LA1837M

Continued from preceding page.

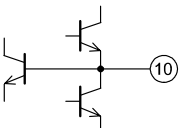
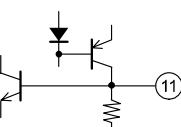
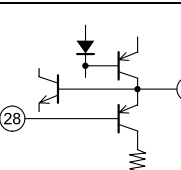
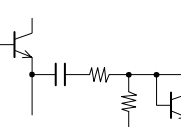
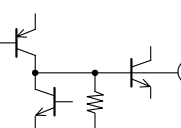
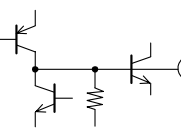
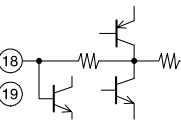
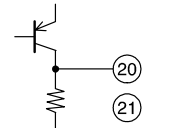
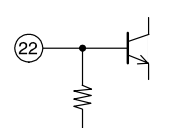
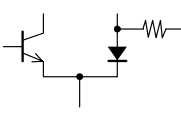
Pin No.	Pin	Pin voltage	Equivalent circuit	Pin function
10	AM narrow band ceramic filter connection	1.3V	 OMP05161	Recommended narrow band ceramic filter BFU450C4N (Murata Mfg. Co., Ltd.) When the narrow band SD function is not used, bypass this circuit by connecting a 50Ω resistor and a 0.047μF capacitor in series.
11	FM S-meter output	0V	 OMP05162	$R_L = 8k\Omega$
12	AM S-meter output, AM SD sensitivity adjustment	0V (AM)	 OMP05163	The AM SD sensitivity can be adjusted with an external resistor between this pin and ground.
13	AM/FM IF buffer output, Output control switch (muting switch)	0V	 OMP05164	$V_{13} \leq 0.5V$: Reception state $1.4V \leq V_{13} \leq 2.2V$: IF buffer output on $V_{13} \geq 3.5V$: IF buffer output and muting on
14	Phase comparator low-pass filter (FM/AM switching)	$V_{CC}-1.4$ (FM) 0V (AM)	 OMP05166	The IC switches to AM mode when this pin is connected to ground through a resistor. Resistor value limits: 2.7kΩ (when $V_{CC} = 7V$) 3.9kΩ (8V) 5.1kΩ (9V) 6.2kΩ (10V) 7.5kΩ (11V)
15	Pilot detector low-pass filter (Forced monaural) (VCO stop)	$V_{CC}-1.0$	 OMP05167	When a current of over 50μA is sourced by this pin, the IC switches to forced monaural mode. The VCO is stopped if this pin is connected to ground. The resistor value limits are the same as for pin 14.
16 17 18 19	Post amplifier I/O	Verg Verg	 OMP05168	Output impedance $r_O = 200\Omega$ Pin 16: right output, pin 17: left output Inverting input pins Pin 18: right input, pin 19: left input $R_{NF} = 33k\Omega$
20 21	Multiplex output	3.5V 3.5V	 OMP05169	Output impedance $r_O = 3.3k\Omega$ Pin 20: Right channel deemphasis Pin 21: Left channel deemphasis
22	Multiplex input	2.9V	 OMP05170	Input impedance $r_i = 20k\Omega$
23	FM demodulated output	2.8V (FM) 2.8V (AM)	 OMP05171	Output impedance $r_O = 3.0k\Omega$ The separation can be adjusted with an external capacitor connected between this pin and ground. The V_{Osub}/V_{Omain} ratio is set to be approximately 0dB.

Continued on next page.

LA1837M

Continued from preceding page.

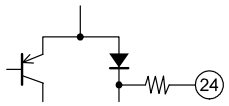
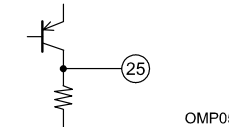
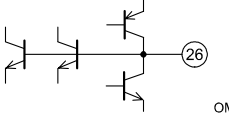
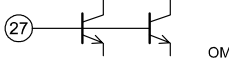
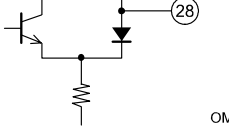
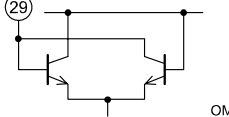
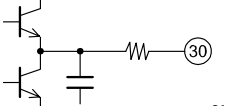
Pin No.	Pin	Pin voltage	Equivalent circuit	Pin function
24	AM detector output	0V (FM) 0.5V (AM)	 OMP05172	Output impedance $r_O = 3.3k\Omega$ The AM frequency characteristics can be adjusted with an RC circuit connected between pin 22 and ground.
25	AM AGC	0V (FM) 0.5V (AM)	 OMP05173	Internal load resistance $R = 11k\Omega$
26	AFC	Vreg	 OMP05174	The FM SD bandwidth can be adjusted with an external resistor connected between this pin and pin 28.
27	AM RF input	Vreg	 OMP05175	This pin must be held at the same potential as pin 28
28	REG	Vreg	 OMP05176	Vreg = 3.6V
29	OSC	Vreg	 OMP05177	Connect the oscillator coil between this pin and pin 28.
30	Oscillator buffer output, FM SD sensitivity adjustment	1.6V (FM) 1.3V (AM)	 OMP05177	The FM SD sensitivity can be adjusted with an external resistor connected between this pin and ground. Output impedance $r_O = 20\Omega$

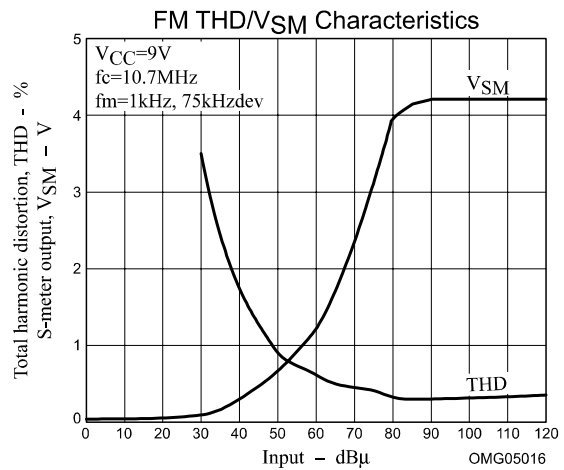
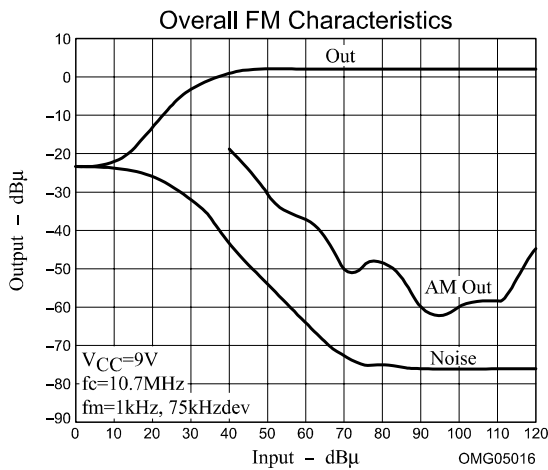

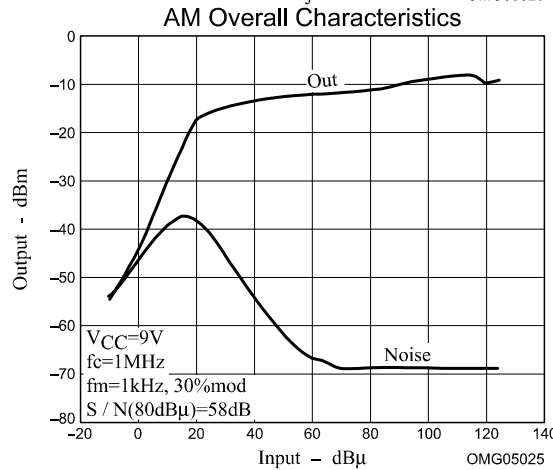
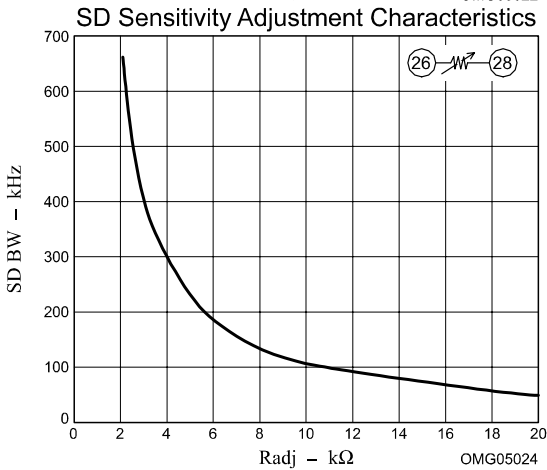
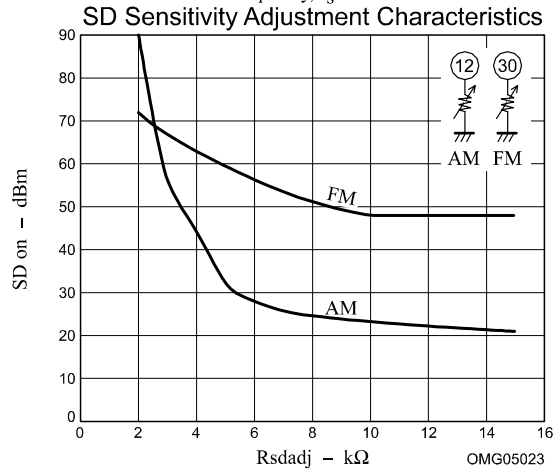
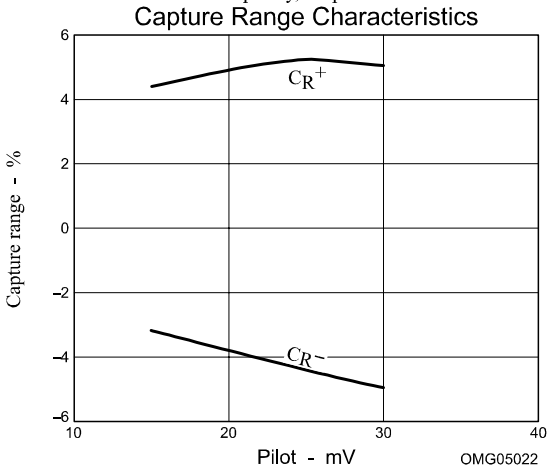
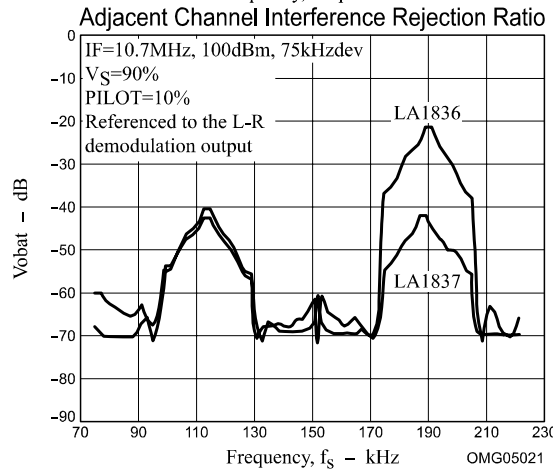
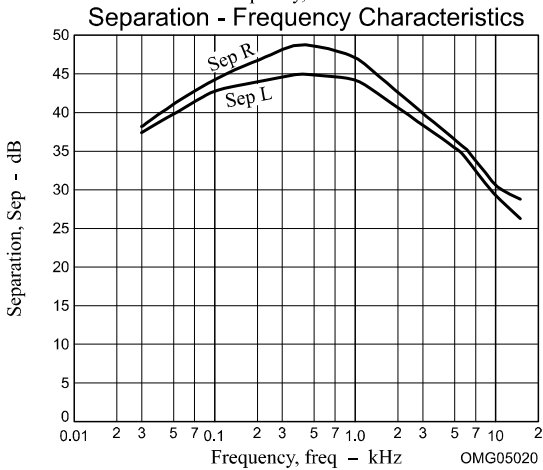
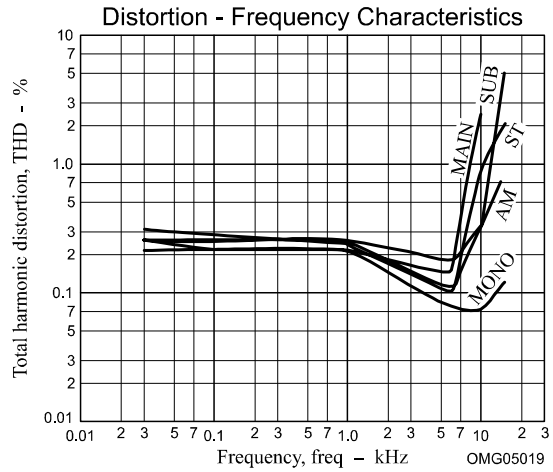
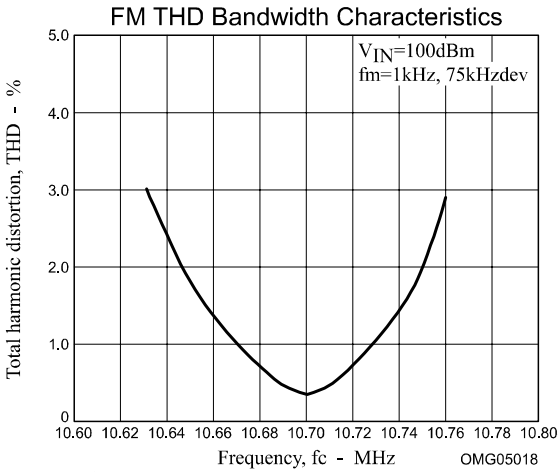

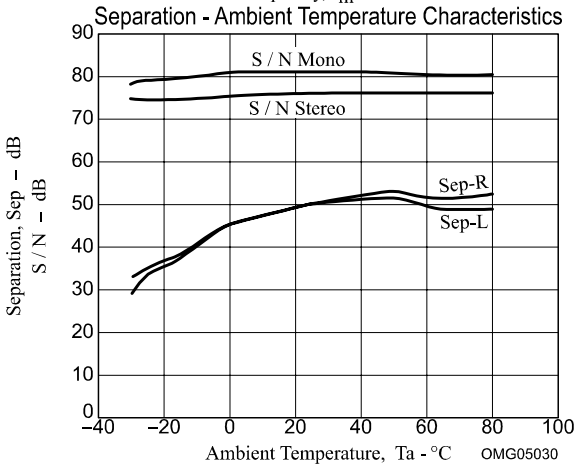
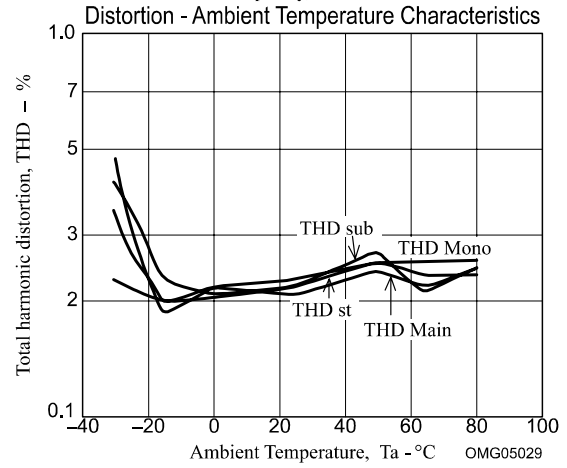
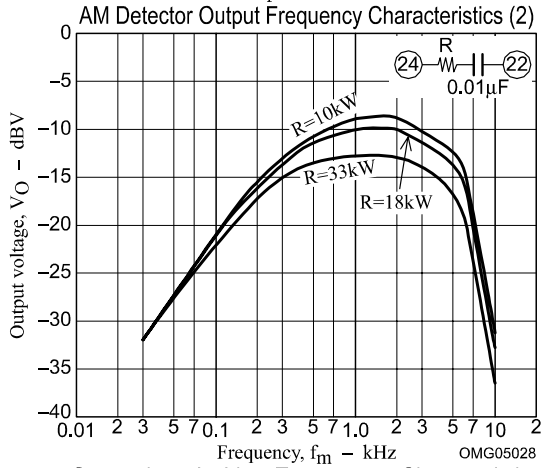
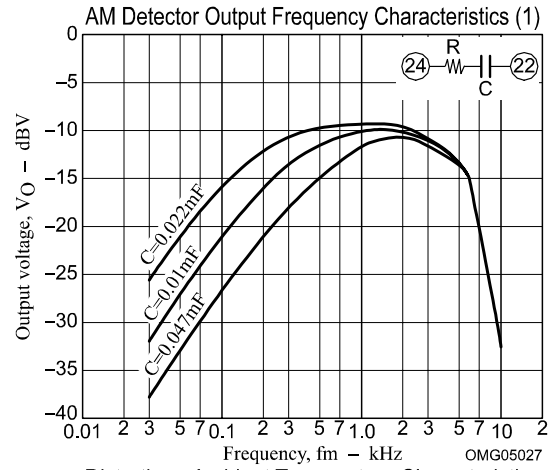
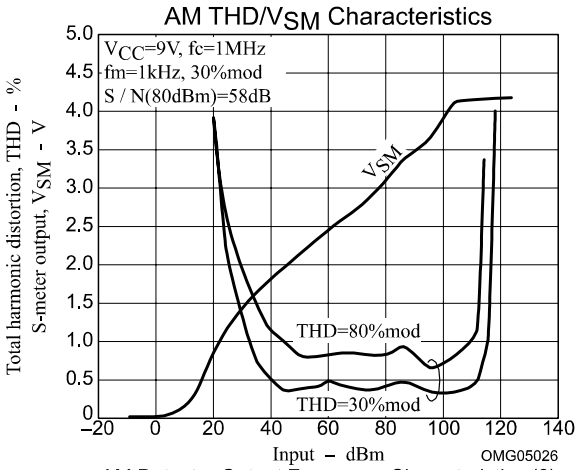

LA1837M

Test Circuit

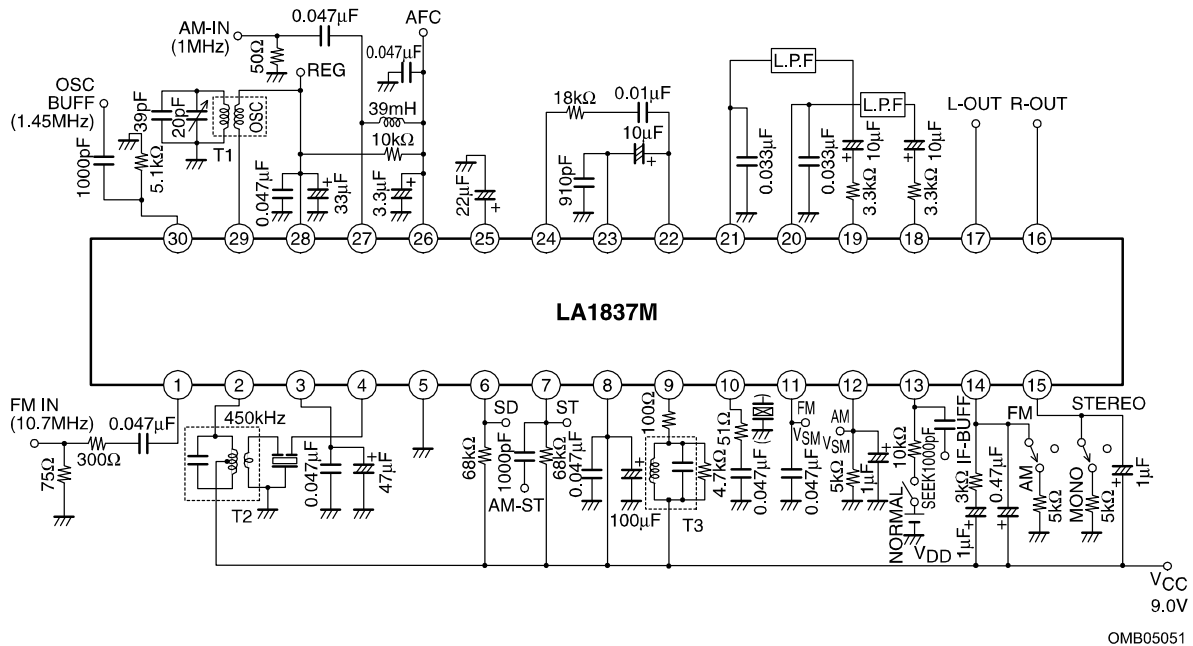

- Specifications of any and all SANYO Semiconductor products described or contained herein stipulate the performance, characteristics, and functions of the described products in the independent state, and are not guarantees of the performance, characteristics, and functions of the described products as mounted in the customer's products or equipment. To verify symptoms and states that cannot be evaluated in an independent device, the customer should always evaluate and test devices mounted in the customer's products or equipment.
- SANYO Semiconductor Co., Ltd. strives to supply high-quality high-reliability products. However, any and all semiconductor products fail with some probability. It is possible that these probabilistic failures could give rise to accidents or events that could endanger human lives, that could give rise to smoke or fire, or that could cause damage to other property. When designing equipment, adopt safety measures so that these kinds of accidents or events cannot occur. Such measures include but are not limited to protective circuits and error prevention circuits for safe design, redundant design, and structural design.
- In the event that any or all SANYO Semiconductor products (including technical data, services) described or contained herein are controlled under any of applicable local export control laws and regulations, such products must not be exported without obtaining the export license from the authorities concerned in accordance with the above law.
- No part of this publication may be reproduced or transmitted in any form or by any means, electronic or mechanical, including photocopying and recording, or any information storage or retrieval system, or otherwise, without the prior written permission of SANYO Semiconductor Co., Ltd.
- Any and all information described or contained herein are subject to change without notice due to product/technology improvement, etc. When designing equipment, refer to the "Delivery Specification" for the SANYO Semiconductor product that you intend to use.
- Information (including circuit diagrams and circuit parameters) herein is for example only; it is not guaranteed for volume production. SANYO Semiconductor believes information herein is accurate and reliable, but no guarantees are made or implied regarding its use or any infringements of intellectual property rights or other rights of third parties.

This catalog provides information as of October, 2005. Specifications and information herein are subject to change without notice.