



Spec. No.	PS-N30BSB4-A0R
Rev.	A

# PRODUCT SPECIFICATION

**Model No: CSPR-N30BSB4-A0R**

Descriptions:
<ul style="list-style-type: none"> <li>• LED Type : Superbright Lamp</li> <li>• LED Package : Piranha LED Lamp</li> <li>• Emitting Color : Blue</li> <li>• Viewing Angle : 70°</li> <li>• Stopper</li> </ul>



CUSTOMER APPROVED SIGNATURES	APPROVED BY	CHECKED BY	PREPARED BY

**CHINA SEMICONDUCTOR CORPORATION**  
Address: 2FL. NO.909, Chung-Cheng Road,  
Chung-Ho City Taipei Hsien, Taiwan.

Tel: 886-2-2223-9696  
Fax: 886-2-2223-9377

**OPTO PLUS TECHNOLOGIES CO.,LTD**  
Address: 696 Shun jiang Rd., Ji Shan St. Shaoxing,  
ZheJiang, China

Tel: 86-0575-88623888  
Fax: 86-0575-88623112



Spec. No.	PS-N30BSB4-A0R
Rev.	A

**Model No: CSPR-N30BSB4-A0R**

**Features -**

1. High Current Operation
2. High Luminous Output
3. High Reliability and Solid
4. Optimal Optical/Mechanical Design
5. Packaged in Tubes for Use with Automatic Pick and Place Equipment
6. Rohs Compliant

**Device Selection Guide -**

Part No.	Chip		LED Lens
	Material	Emitted Color	
CSPR-N30BSB4-A0R	InGaN	Blue	Water Transparent

**Package Outline Dimensions -**

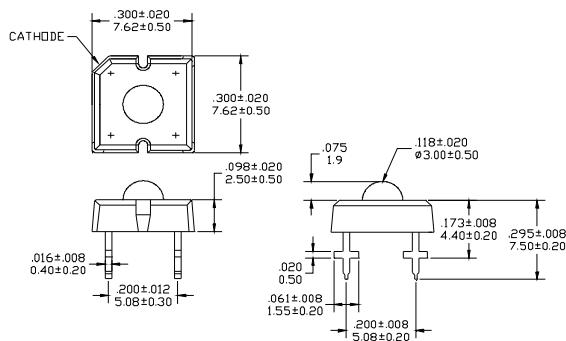

\* Tolerance :  $\pm 0.25$ [0.01] Unit :  $\pm$ mm[inch]



Spec. No.	PS-N30BSB4-A0R
Rev.	A

Model No: CSPR-N30BSB4-A0R

■ Absolute Maximum Rating -

(Ta=25°C)

Parameter	Symbol	Rating	Unit
Power Dissipation	<b>Pd</b>	120	mW
Forward Current (DC)	<b>IF</b>	40	mA
Peak Forward Current *	<b>IFP</b>	100	mA
Reverse Voltage	<b>VR</b>	5	V
Operating Temp.	<b>Topr</b>	-30 ~ +80	°C
Storage Temp.	<b>Tstg</b>	-40 ~ +100	°C
Lead Soldering Temperature	<b>Tsol</b>	Max. 260°C for 5 sec Max. (3mm from the epoxy bulb)	

\* Pulse width  $\leq 0.1$  msec. duty  $\leq 1/10$

■ Electro-optical Characteristics -

(Ta=25°C)

Parameter	Symbol	Min.	Typ.	Max.	Unit	Condition
Forward Voltage	<b>VF</b>	-----	3.5	4.0	V	IF=30mA
Luminous Flux	<b>Φv</b>	1000	2000	-----	mlm	
Dominant Wavelength	<b>λ d</b>	-----	465	-----		
Viewing Angle	<b>2θ 1/2</b>	-----	70	-----	deg	
Reverse Current	<b>IR</b>	-----	-----	50	μA	VR=5V



■ Luminous Flux Rank Limits (  $I_F = 30\text{mA}$  )

unit : mlm

Part No. Code	CSPR-N30BSB4-A0R	
	min.	max.
B	1000	1500
C	1500	2000
D	2000	2500
E	2500	3000
F	3000	3500

■ Dominant Wavelength Rank Limits (  $I_F = 30\text{mA}$  )

unit : nm

Part No. Code	CSPR-N30BSB4-A0R	
	min.	max.
B5	460	465
B6	465	470
B7	470	475

■ Forward Voltage Rank Limits (  $I_F = 30\text{mA}$  )

unit : V

Part No. Code	CSPR-N30BSB4-A0R	
	min.	max.
J	3.0	3.2
K	3.2	3.4
L	3.4	3.6
M	3.6	3.8
N	3.8	4.0

Notes:

1. Tolerance of measurement of luminous Flux :±15 %
2. Tolerance of measurement of dominant wavelength :±2nm
3. Tolerance of measurement of forward voltage :±0.05v
4. All data are measured by CSC's test equipment.
5. One delivery will include several color rank, VF rank and Iv ranks of the products.
6. The quantity-ratio of the ranks is decided by CSC.
7. Please confirm with CSC salesman,if your request different form standard specification.



Spec. No.	PS-N30BSB4-A0R
Rev.	A

Model No: CSPR-N30BSB4-A0R

### ■ Typical Electrical / Optical Characteristics Curves -

(Ta = 25°C Unless Otherwise Noted)

Fig 1. Forward Current Vs. Forward Voltage

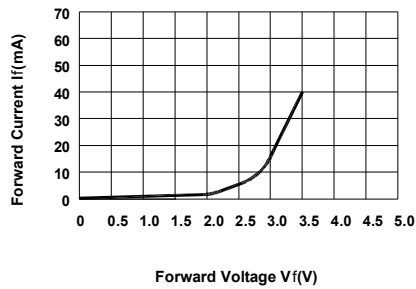

Fig 2. Relative Luminous Flux Vs. Forward Current

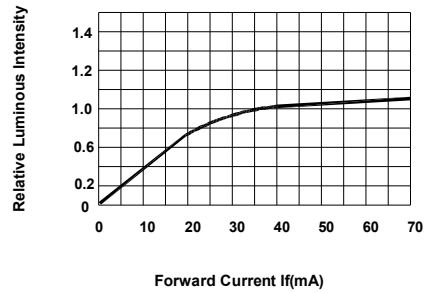

Fig 3. Forward Current Vs. Ambient Temperature  
(Rθ j-a=300°C/W)

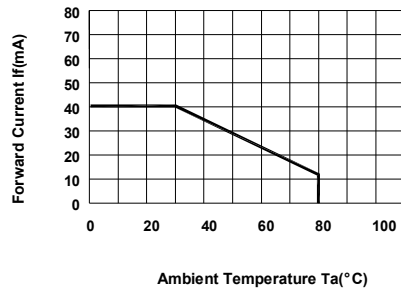

Fig 4. Relative Intensity Vs. Wavelength

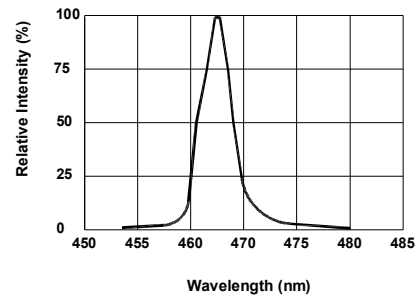
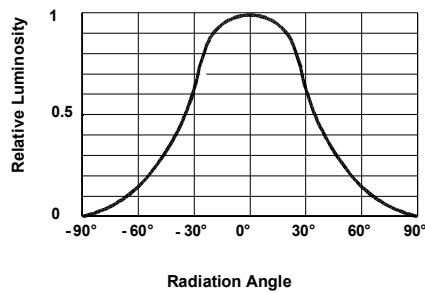

Fig 5. Radiation Diagram





**Model No : CSPR-N30BSB4-A0R**

**Precautions For Use -**

**1. Recommended Soldering conditions**

**Wave Soldering**

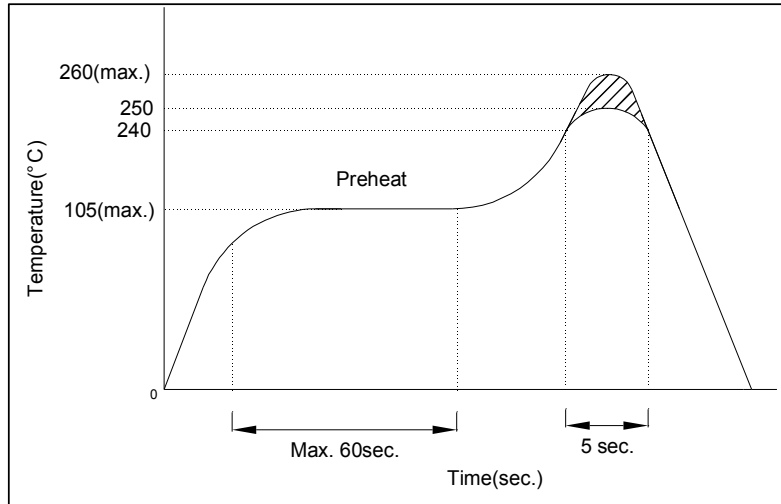

**2. Soldering Iron**

Basic SPEC. is  $\leq 5\text{sec.}$  When  $260^{\circ}\text{C}$ . If temperature is higher, time should be shorter ( $+10^{\circ}\text{C} \rightarrow -1\text{sec.}$ ). Power dissipation of iron should be smaller than 15W, and temperature should be controllable. Surface temperature of the device should be under  $230^{\circ}\text{C}$ .

**3. Static Electricity**

- a. Static electricity or surge voltage damages LEDs..  
It is recommended that a wrist band or an anit-electrostatic glove be used when handling the LEDs.
- b. All devices, equipment and machinery must be properly grounded. It is recommended that mesures be taken against surge voltage to the equipment that mounts the LEDs.

**Revision History**

Rev. NO	Date	Change Description
A	2009-7-30	

CSC has the right to updata the information without notice,  
Please confirm with CSC salesman for the latest version.