

78 Series Regulators

1A Output 78 series Regulators

500mA Output 78 series Regulators



BA78□□Series, BA78M□□Series

No.09019EBT01

●Description

BA78□□, BA78M□□ series are three-terminal regulators available with several fixed output voltages. It supplies the stable fixed voltage from unstable direct input voltage. The useful output voltage lineup is 5V, 6V, 7V, 8V, 9V, 10V, 12V, 15V, 18V, 20V, 24V with 0.5A / 1A current ability. They have nearly same electric characteristics as competitor products and cover a wide range of application.

●Features

- 1) Built-in over-current protection circuit and thermal shutdown circuit
- 2) High ripple rejection
- 3) Available TO220CP-3, TO252-3 package to a wide range application
- 4) Compatible replacement to competitor products
- 5) Various voltage lineup (5V, 6V, 7V, 8V, 9V, 10V, 12V, 15V, 18V, 20V, 24V)

●Applications

Fixed voltage power supply for TV, Audio components, etc

●Line up

■1A BA78□□Series

Part Number	5V	6V	7V	8V	9V	10V	12V	15V	18V	20V	24V	Package
BA78□□CP	○	○	○	○	○	○	○	○	○	○	○	TO220CP-3
BA78□□FP	○	○	○	○	○	○	○	○	○	○	○	TO252-3

■0.5A BA78M□□Series

Part Number	5V	6V	7V	8V	9V	10V	12V	15V	18V	20V	24V	Package
BA78M□□CP	○	○	○	○	○	○	○	○	○	○	○	TO220CP-3
BA78M□□FP	○	○	○	○	○	○	○	○	○	○	○	TO252-3

●Output Voltage and Marking

Part Number : BA78□□□□ (1A)
a b

Part Number : BA78M□□□□ (0.5A)
a b

Symbol	assignment of output voltage			
a	□□	Output voltage(V)	□□	Output voltage(V)
	05	5.0V typ.	12	12V typ.
	06	6.0V typ.	15	15V typ.
	07	7.0V typ.	18	18V typ.
	08	8.0V typ.	20	20V typ.
	09	9.0V typ.	24	24V typ.
b	Package			
	CP : TO220CP-3 FP : TO252-3			

Symbol	assignment of output voltage			
a	□□	Output voltage(V)	□□	Output voltage(V)
	05	5.0V typ.	12	12V typ.
	06	6.0V typ.	15	15V typ.
	07	7.0V typ.	18	18V typ.
	08	8.0V typ.	20	20V typ.
	09	9.0V typ.	24	24V typ.
b	Package			
	CP : TO220CP-3 FP : TO252-3			

●Absolute Maximum Rating (Ta=25°C)

BA78□□CP/FP, BA78M□□CP/FP

Parameter		Symbol	Limits	Unit
Power supply voltage		Vin	35	V
Power Dissipation 1	TO220CP-3	Pd1	2 ^{*1}	W
	TO252-3		1 ^{*1}	
Power Dissipation 2	TO220CP-3	Pd2	22 ^{*2}	W
	TO252-3		10 ^{*2}	
Output Current	BA78□□	Io	1 ^{*3}	A
	BA78□□M		0.5 ^{*3}	
Operating Temperature Range		Topr	-40~+85	°C
Storage Temperature Range		Tstg	-55~+150	°C
Operating Junction Temperature Range		Tj	-40~+150	°C

*1 Derating in done 16mW/°C(TO220CP-3), 8mW/°C(TO252-3) for temperatures above Ta=25°C

*2 Derating in done 176mW/°C(TO220CP-3), 80mW/°C(TO252-3) for temperatures above Ta=25°C, Mounted on infinity Aluminium heat sink.

*3 Pd,ASO and Tjmax(150°C) should not be exceeded.

●Operating Conditions(Ta=25°C, Pd should not be exceeded)

BA78□□CP/FP

Parameter	Symbol	Min.	Max.	Unit.
Input Voltage	BA7805	7.5	25	V
	BA7806	8.5	21	
	BA7807	9.5	22	
	BA7808	10.5	23	
	BA7809	11.5	26	
	BA7810	12.5	25	
	BA7812	14.5	27	
	BA7815	17.5	30	
	BA7818	21	33	
	BA7820	23	33	
BA7824	27	33		
Output Current	Io	-	1	A

BA78M□□CP/FP

Parameter	Symbol	Min.	Max.	Unit.		
Input Voltage	BA78M05	7.5	25	V		
	BA78M06	8.5	21			
	BA78M07	9.5	22			
	BA78M08	10.5	23			
	BA78M09	11.5	26			
	BA78M10	12.5	25			
	BA78M12	14.5	27			
	BA78M15	17.5	30			
	BA78M18	21	33			
	BA78M20	23	33			
	BA78M24	27	33			
	Output Current	Io	-		0.5	A

●Electrical Characteristics BA78M□□CP/FP

(Ta=25°C, Vin=10V(05),11V(06),13V(07),14V(08),15V(09),16V(10),19V(12),23V(15),27V(18),29V(20),33V(24), Io=350mA unless otherwise specified)

Parameter	Symbol	Type	Limit			Unit	Condition		
			Min	Typ	Max				
Output Voltage 1	Vo1	05	4.8	5.0	5.2	V	Io=350mA		
		06	5.75	6.0	6.25				
		07	6.7	7.0	7.3				
		08	7.7	8.0	8.3				
		09	8.6	9.0	9.4				
		10	9.6	10.0	10.4				
		12	11.5	12.0	12.5				
		15	14.4	15.0	15.6				
		18	17.3	18.0	18.7				
Output Voltage 2	Vo2	10	19.2	20.0	20.8	V	Io=350mA		
		24	23.0	24.0	25.0				
		05	4.75	-	5.25			V	Vin=7.5~20V, Io=5mA~350mA
		06	5.7	-	6.3				Vin=8.5~21V, Io=5mA~350mA
		07	6.65	-	7.35				Vin=9.5~22V, Io=5mA~350mA
		08	7.6	-	8.4				Vin=10.5~23V, Io=5mA~350mA
		09	8.55	-	9.45				Vin=11.5~24V, Io=5mA~350mA
		10	9.5	-	10.5				Vin=12.5~25V, Io=5mA~350mA
		12	11.4	-	12.6				Vin=15~27V, Io=5mA~350mA
15	14.25	-	15.75	Vin=17.5~30V, Io=5mA~350mA					
18	17.1	-	18.9	Vin=21~33V, Io=5mA~350mA					
20	19.0	-	21.0	Vin=23~33V, Io=5mA~350mA					
24	22.8	-	25.2	Vin=27~33V, Io=5mA~350mA					
Line Regulation 1	Reg.I1	05	-	3	100	mV	Vin=7~25V, Io=200mA		
		06	-	3	100		Vin=8~25V, Io=200mA		
		07	-	4	100		Vin=9~25V, Io=200mA		
		08	-	4	100		Vin=10.5~25V, Io=200mA		
		09	-	4	100		Vin=11.5~26V, Io=200mA		
		10	-	5	100		Vin=12.5~28V, Io=200mA		
		12	-	5	100		Vin=14.5~30V, Io=200mA		
		15	-	6	100		Vin=17.5~30V, Io=200mA		
		18	-	7	100		Vin=21~33V, Io=200mA		
Line Regulation 2	Reg.I2	20	-	8	100	mV	Vin=23~33V, Io=200mA		
		24	-	10	100		Vin=27~33V, Io=200mA		
		05	-	1	50		Vin=8~12V, Io=200mA		
		06	-	1	50		Vin=9~25V, Io=200mA		
		07	-	1	50		Vin=10~25V, Io=200mA		
		08	-	1	50		Vin=11~25V, Io=200mA		
		09	-	2	50		Vin=12~25V, Io=200mA		
		10	-	2	50		Vin=14~26V, Io=200mA		
		12	-	3	50		Vin=16~30V, Io=200mA		
Ripple Rejection	R.R.	15	-	3	50	dB	Vin=20~30V, Io=200mA		
		18	-	3	50		Vin=24~33V, Io=200mA		
		20	-	4	50		Vin=24~33V, Io=200mA		
		24	-	5	50		Vin=28~33V, Io=200mA		
		05	62	78	-		Io=100mA	ein=1Vrms, f=120Hz, Io=100mA	
		06	60	74	-				
		07	57	71	-				
		08	56	69	-				
		09	56	67	-				
10	56	66	-						
12	55	63	-						
15	54	60	-						
18	53	58	-						
Temperature Coefficient of Output Voltage	Tcvo	05	-	-1.0	-	mV/°C	Io=5mA, Tj=0~125°C		
		06/07/08/09/10/12	-	-0.5	-				
		15/18	-	-0.6	-				
		20/24	-	-0.7	-				
Peak Output Current	Io-p	common	-	875	-	mA	Tj=25°C		
Dropout Voltage	Vd	common	-	2.0	-	V	Io=500mA		

●Electrical Characteristics BA78M□□CP/FP

(Ta=25°C, Vin=10V(05), 11V(06), 13V(07), 14V(08), 15V(09), 16V(10), 19V(12), 23V(15), 27V(18), 29V(20), 33V(24), Io=350mA unless otherwise specified)

Parameter	Symbol	Type	Limit			Unit	Condition
			Min	Typ	Max		
Load Regulation 1	Reg.L1	05	-	20	100	mV	Io=5mA~500mA
		06	-	20	120		
		07	-	20	140		
		08	-	20	160		
		09	-	20	180		
		10	-	20	200		
		12	-	20	240		
		15	-	20	300		
		18	-	20	360		
		20	-	20	400		
Load Regulation 2	Reg.L2	05	-	10	50	mV	Io=5mA~200mA
		06	-	10	60		
		07	-	10	70		
		08	-	10	80		
		09	-	10	90		
		10	-	10	100		
		12	-	10	120		
		15	-	10	150		
		18	-	10	180		
		20	-	10	200		
Output Noise Voltage	Vn	05	-	40	-	μV	f=10Hz~100kHz
		06	-	60	-		
		07	-	70	-		
		08	-	80	-		
		09	-	90	-		
		10	-	100	-		
		12	-	110	-		
		15	-	130	-		
		18	-	140	-		
		20	-	150	-		
Bias Current	Ib	common	-	4.5	6.0	mA	Io=0mA
Bias Current Change1	Ib1	common	-	-	0.5	mA	Io=5mA~350mA
Bias Current Change 2	Ib2	05	-	-	0.8	mA	Vin:8~25V, Io=200mA
		06	-	-	0.8		Vin:9~25V, Io=200mA
		07	-	-	0.8		Vin:10~25V, Io=200mA
		08	-	-	0.8		Vin:10.5~25V, Io=200mA
		09	-	-	0.8		Vin:12~25V, Io=200mA
		10	-	-	0.8		Vin:13~25V, Io=200mA
		12	-	-	0.8		Vin:14.5~30V, Io=200mA
		15	-	-	0.8		Vin:17.5~30V, Io=200mA
		18	-	-	0.8		Vin:21~33V, Io=200mA
		20	-	-	0.8		Vin:23~33V, Io=200mA
Short-Circuit Output Current	Ios	05/06/07/08	-	0.4	-	A	Vin=25V
		09/10/12/15/18/20/24	-	0.17	-		Vin=30V
Output Resistance	Ro	05	-	9	-	mΩ	f=1kHz
		06	-	10	-		
		07	-	11	-		
		08	-	12	-		
		09	-	13	-		
		10	-	14	-		
		12	-	16	-		
		15	-	19	-		
		18	-	22	-		
		20	-	25	-		
		24	-	37	-		

●Electrical Characteristics BA78□□CP/FP

(Ta=25°C, Vin=10V(05), 11V(06), 13V(07), 14V(08), 15V(09), 16V(10), 19V(12), 23V(15), 27V(18), 29V(20), 33V(24), Io=500mA unless otherwise specified)

Parameter	Symbol	Type	Limit			Unit	Condition		
			Min	Typ	Max				
Output Voltage 1	Vo1	05	4.8	5.0	5.2	V	Io=500mA		
		06	5.75	6.0	6.25				
		07	6.7	7.0	7.3				
		08	7.7	8.0	8.3				
		09	8.6	9.0	9.4				
		10	9.6	10.0	10.4				
		12	11.5	12.0	12.5				
		15	14.4	15.0	15.6				
		18	17.3	18.0	18.7				
Output Voltage 2	Vo2	10	19.2	20.0	20.8	V	Io=500mA		
		24	23.0	24.0	25.0				
		05	4.75	-	5.25			V	Vin=7.5~20V, Io=5mA~1A
		06	5.7	-	6.3				Vin=8.5~21V, Io=5mA~1A
		07	6.65	-	7.35				Vin=9.5~22V, Io=5mA~1A
		08	7.6	-	8.4				Vin=10.5~23V, Io=5mA~1A
		09	8.55	-	9.45				Vin=11.5~26V, Io=5mA~1A
		10	9.5	-	10.5				Vin=12.5~25V, Io=5mA~1A
		12	11.4	-	12.6				Vin=15~27V, Io=5mA~1A
15	14.25	-	15.75	Vin=17.5~30V, Io=5mA~1A					
18	17.1	-	18.9	Vin=21~33V, Io=5mA~1A					
20	19.0	-	21.0	Vin=23~33V, Io=5mA~1A					
24	22.8	-	25.2	Vin=27~33V, Io=5mA~1A					
Line Regulation 1	Reg.11	05	-	3	100	mV	Vin=7~25V, Io=500mA		
		06	-	4	120		Vin=8~25V, Io=500mA		
		07	-	5	140		Vin=9~25V, Io=500mA		
		08	-	5	160		Vin=10.5~25V, Io=500mA		
		09	-	6	180		Vin=11.5~26V, Io=500mA		
		10	-	7	200		Vin=12.5~27V, Io=500mA		
		12	-	8	240		Vin=14.5~30V, Io=500mA		
		15	-	9	300		Vin=17.5~30V, Io=500mA		
		18	-	10	360		Vin=21~33V, Io=500mA		
Line Regulation 2	Reg.12	20	-	12	400	mV	Vin=23~33V, Io=500mA		
		24	-	15	480		Vin=27~33V, Io=500mA		
		05	-	1	50		Vin=8~12V, Io=500mA		
		06	-	2	60		Vin=9~13V, Io=500mA		
		07	-	2	70		Vin=10~15V, Io=500mA		
		08	-	3	80		Vin=11~17V, Io=500mA		
		09	-	4	90		Vin=13~19V, Io=500mA		
		10	-	4	100		Vin=14~20V, Io=500mA		
		12	-	5	120		Vin=16~22V, Io=500mA		
Ripple Rejection	R.R.	15	-	5	150	dB	Vin=20~26V, Io=500mA		
		18	-	5	180		Vin=24~30V, Io=500mA		
		20	-	7	200		Vin=26~32V, Io=500mA		
		24	-	10	240		Vin=30~33V, Io=500mA		
		05	62	78	-		Io=100mA, f=120Hz, ein=1Vrms		
		06	59	73	-				
		07	57	69	-				
		08	56	65	-				
		09	56	64	-				
10	55	64	-						
12	55	63	-						
15	54	62	-						
18	53	61	-						
Temperature Coefficient of Output Voltage	Tcvo	05	-	-1.0	-	mV/°C	Io=5mA, Tj=0~125°C		
		06/07/08/09/10/12	-	-0.5	-				
		15/18	-	-0.6	-				
		20/24	-	-0.7	-				
Peak Output Current	Io-p	common	-	1.7	-	A	Tj=25°C		
Dropout Voltage	Vd	common	-	2.0	-	V	Io=1A		

●Electrical Characteristics BA78□□CP/FP

(Ta=25°C, Vin=10V(05), 11V(06), 13V(07), 14V(08), 15V(09), 16V(10), 19V(12), 23V(15), 27V(18), 29V(20), 33V(24), Io=500mA unless otherwise specified)

Parameter	Symbol	Type	Limit			Unit	Condition
			Min	Typ	Max		
Load Regulation 1	Reg.L1	05	-	15	100	mV	Io=5mA~1A
		06	-	16	120		
		07	-	17	140		
		08	-	19	160		
		09	-	20	180		
		10	-	21	200		
		12	-	23	200		
		15	-	27	300		
		18	-	30	360		
		20	-	32	400		
Load Regulation 2	Reg.L2	05	-	5	50	mV	Io=250mA~750mA
		06	-	6	60		
		07	-	6	70		
		08	-	7	80		
		09	-	8	90		
		10	-	8	90		
		12	-	10	100		
		15	-	10	150		
		18	-	12	180		
		20	-	14	200		
Output Noise Voltage	Vn	05	-	40	-	μV	f=10Hz~100kHz
		06	-	60	-		
		07	-	70	-		
		08	-	80	-		
		09	-	90	-		
		10	-	100	-		
		12	-	110	-		
		15	-	125	-		
		18	-	140	-		
		20	-	150	-		
Bias Current	Ib	common	-	4.5	8.0	mA	Io=0mA
Bias Current Change 1	Ib1	common	-	-	0.5	mA	Io=5mA~1A
Bias Current Change 2	Ib2	05	-	-	0.8	mA	Vin:8~25V, Io=500mA
		06	-	-	0.8		Vin:8.5~25V, Io=500mA
		07	-	-	0.8		Vin:9.5~25V, Io=500mA
		08	-	-	0.8		Vin:10.5~25V, Io=500mA
		09	-	-	0.8		Vin:11.5~26V, Io=500mA
		10	-	-	0.8		Vin:12.5~27V, Io=500mA
		12	-	-	0.8		Vin:14.5~30V, Io=500mA
		15	-	-	0.8		Vin:17.5~30V, Io=500mA
		18	-	-	0.8		Vin:21~33V, Io=500mA
		20	-	-	0.8		Vin:23~33V, Io=500mA
Short-Circuit Output Current	Ios	05/06/07/08	-	0.6	-	A	Vin=25V
		09/10/12/15/18/20/24	-	0.3	-		Vin=30V
Output Resistance	Ro	05	-	9	-	mΩ	f=1kHz
		06	-	10	-		
		07	-	10	-		
		08	-	10	-		
		09	-	10	-		
		10	-	11	-		
		12	-	12	-		
		15	-	14	-		
		18	-	17	-		
		20	-	19	-		
24	-	27	-				

●BA78M□□ Characteristics data (Ta=25°C, Vin=10V(05), 14V(08), 23V(15) unless otherwise specified)

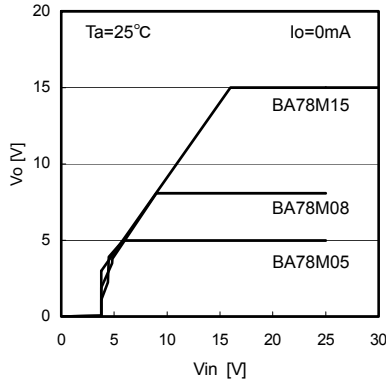

Fig.1 Line Regulation (Io=0mA)

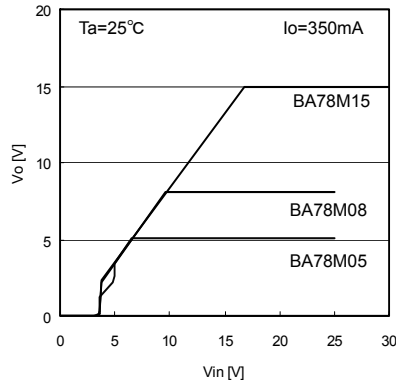

Fig.2 Line Regulation (Io=350mA)

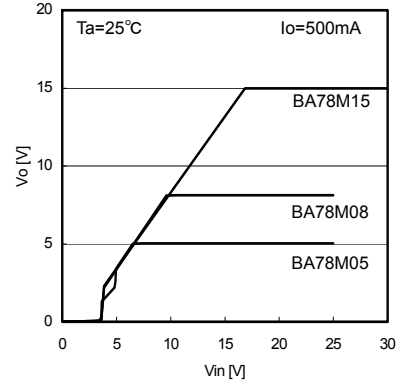

Fig.3 Line Regulation (Io=500mA)

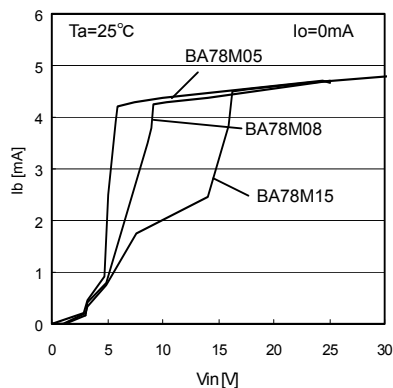

Fig.4 Vin - Ib

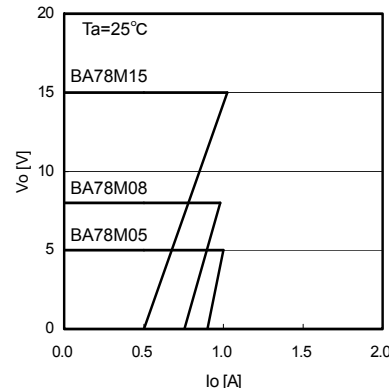

Fig.5 Load Regulation

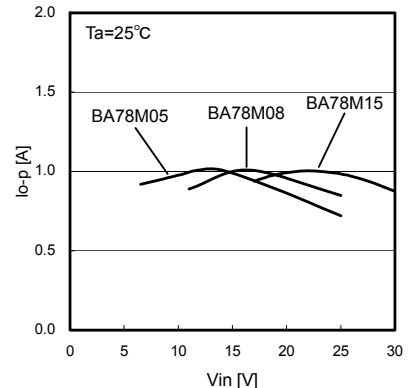

Fig.6 Peak Output Current

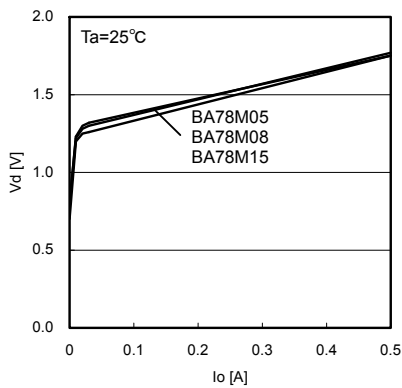

Fig.7 Dropout Voltage

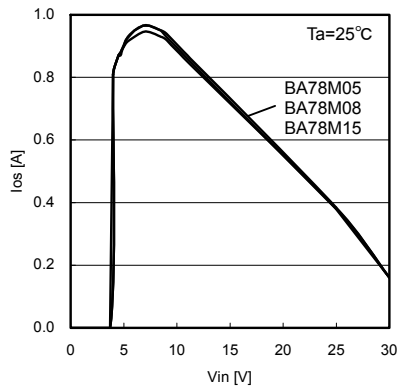

Fig.8 Short - Circuit Output Current

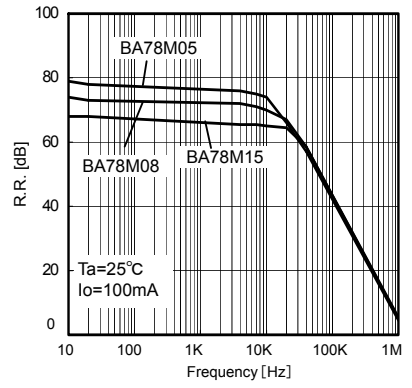

Fig.9 Ripple Rejection Ratio

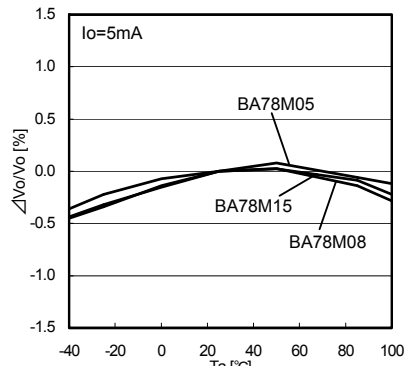

Fig.10 Ta - Vo

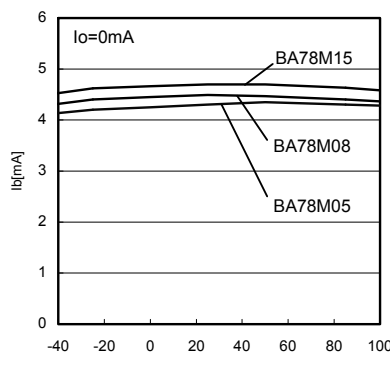

Fig.11 Ta - Ib

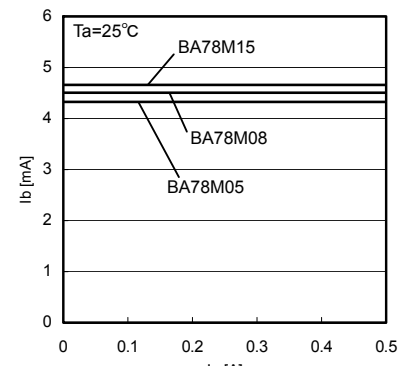

Fig.12 Io - Ib

●BA78□□ Characteristics data (Ta=25°C, Vin=10V(05), 14V(08), 23V(15) unless otherwise specified)

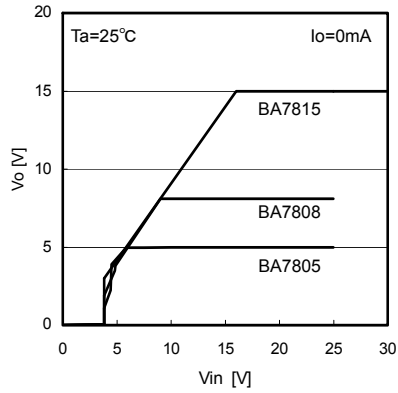

Fig.13 Line Regulation (Io=0mA)

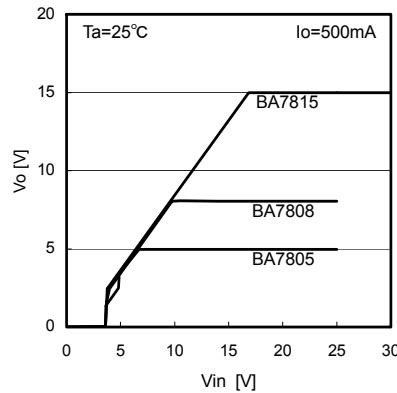

Fig.14 Line Regulation (Io=500mA)

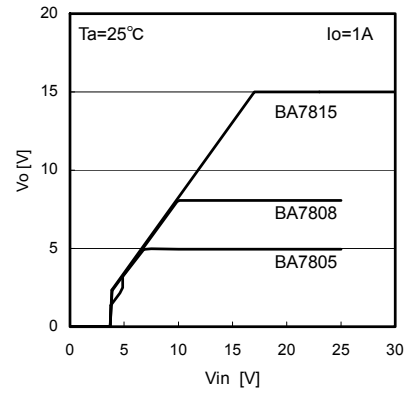

Fig.15 Line Regulation (Io=1A)

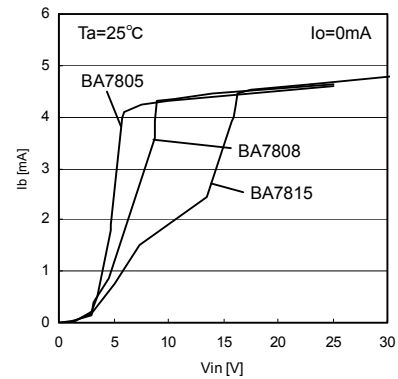

Fig.16 Vin - Ib

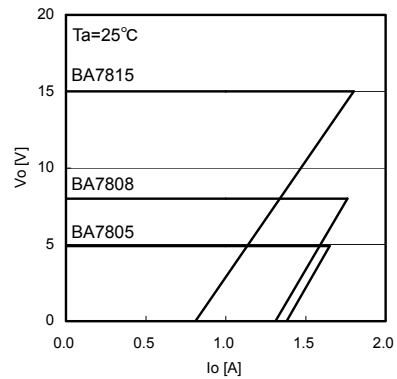

Fig.17 Load Regulation

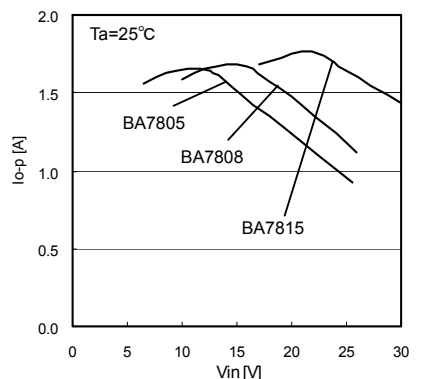

Fig.18 Peak Output Current

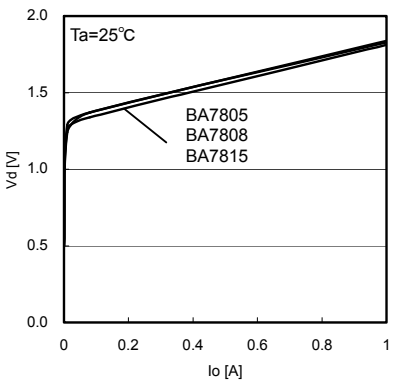

Fig.19 Dropout Voltage

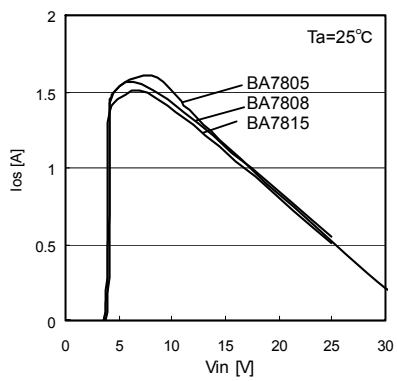

Fig.20 Short - Circuit Output Current

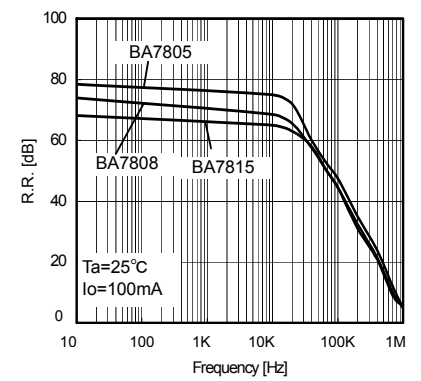

Fig.21 Ripple Rejection Ratio

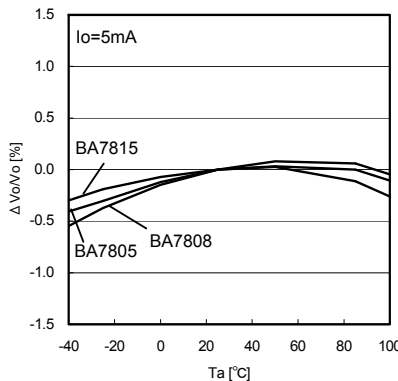

Fig.22 Ta - Vo

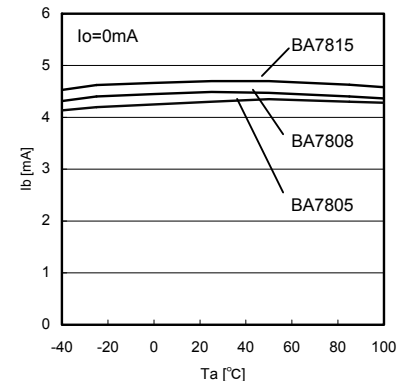

Fig.23 Ta - Ib

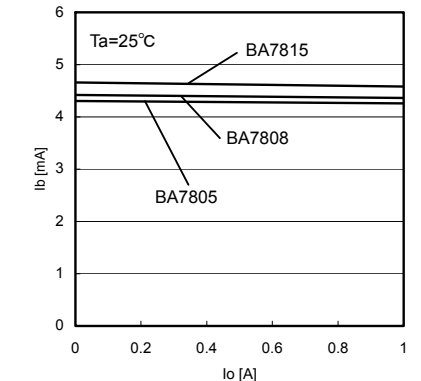
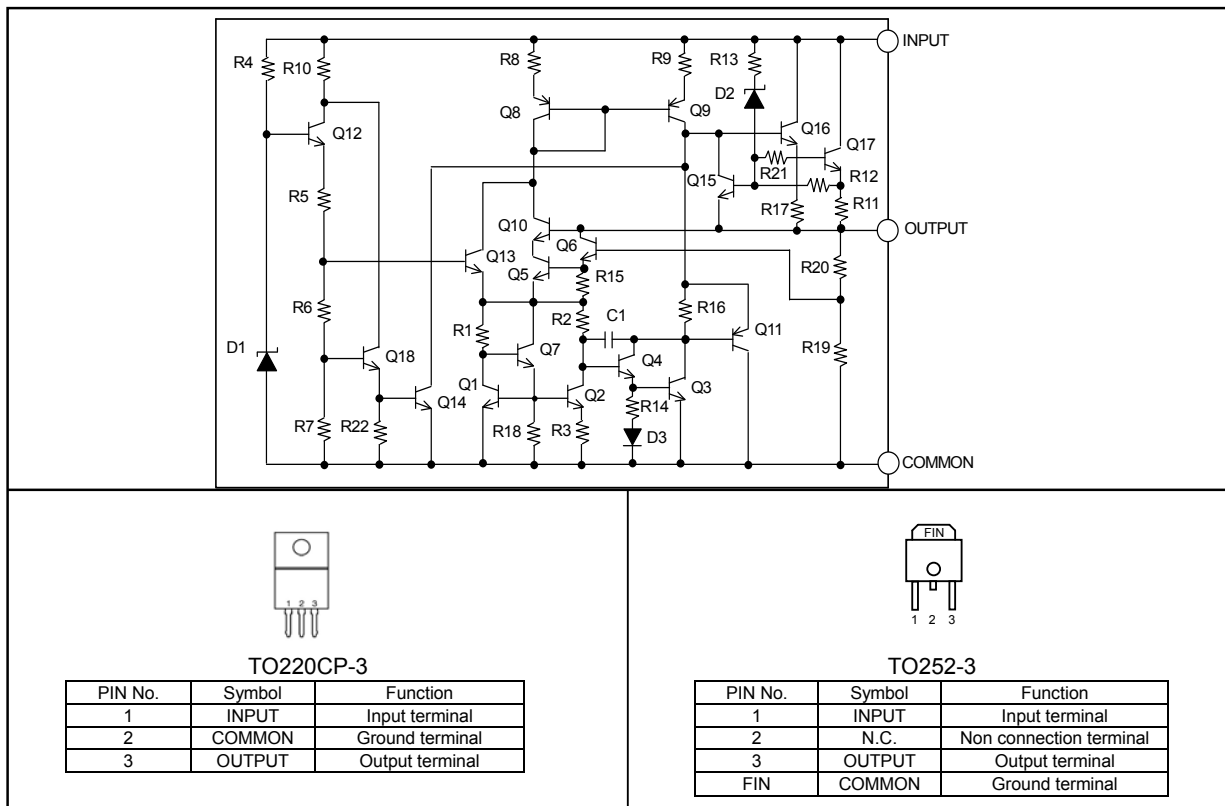

Fig.24 Io - Ib

●Internal Circuit Structural Diagram



●Protection Circuit

(1)Over-current protection circuit

When the maximum rating current or more is rushed, it controls the current ability and protects the IC from destruction.

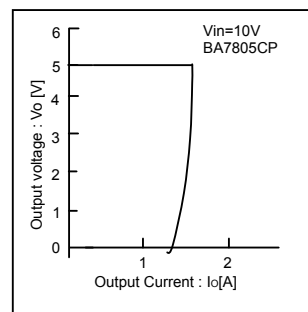

(2) Thermal shutdown circuit

When the chip temperature of IC exceeds the setting temperature, the IC goes OFF, and it controls the IC not to be destroyed by the heat generation. It can be restored by being lowered the chip temperature of IC below the setting temperature.

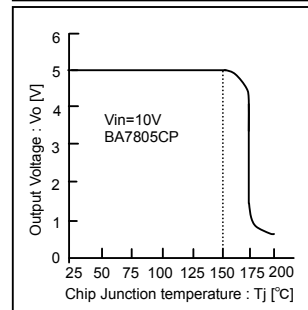

(3) Safety operation area control circuit

It controls the output current in inverse proportion ratio to voltage difference (input-output). When voltage difference becomes bigger, the IC will be destroyed in rush current. It protects the IC by controlling the current ability according to the voltage level.

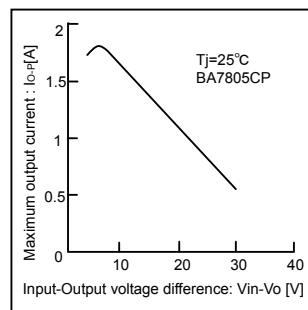

●Thermal design

Refer to the following thermal derating curves (Fig. 25, 26), when using in the status of Ta=25°C or more.
 The characteristic of IC is greatly related to the operating temperature.
 When it is used in over maximum junction temperature, the elements inside IC might become weaker and be destroyed.
 It is recommended to take into consideration thermal of IC.
 Note that the temperatures are in the allowed temperature limits and operated within Pd.

It is necessary to operate it at junction temperature Tjmax or less to prevent IC from the thermal destruction.

Please operate IC within permissible loss Pd because the junction temperature Tj might become considerably a high temperature even if ambient temperature Ta is normal temperature (25°C).

Power consumption Pc(W) may be expressed by the equation shown below:

$$Pc = (V_{in} - V_o) \times I_o + V_{in} \times I_b$$

permissible loss $P_d \geq Pc$

V_{in} : Input Voltage
 V_o : Output Voltage
 I_o : Output Current
 I_b : Bias current

$$I_o \leq \frac{P_d - V_{in} \times I_b}{V_{in} - V_o}$$

Maximum Output current I_{oMAX} can be calculated in thermal design.

• Calculation example

Ex.1) Ta=85°C, Vin =7.5V, Vo=5.0V

$$I_o \leq \frac{1.04 - 7.5 \times 4.5m}{7.5 - 5.0}$$

$$I_o \leq 400mA$$

Using TO220CP-3 alone
 θja=62.5°C/W→16mW/°C
 Pd=1.04W at 85°C

Be sure to use this IC within a power dissipation at the range of operating temperature.

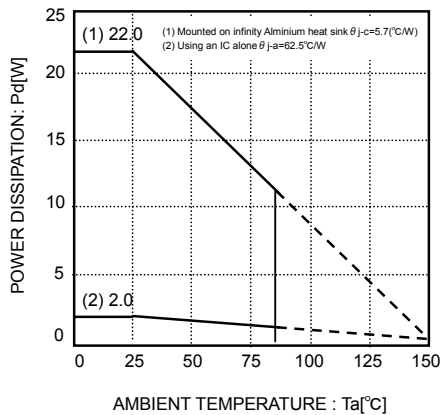

Fig.25 Thermal derating curve (TO220CP-3)

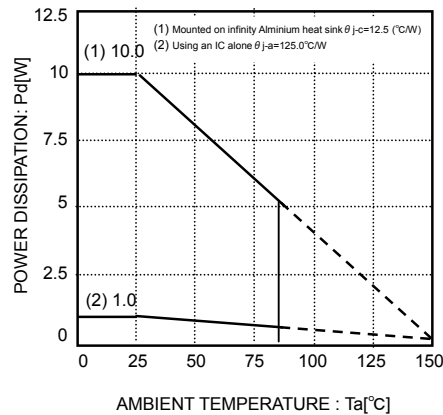

Fig.26 Thermal derating curve (TO252-3)

●Terminal Setting and Cautions

• INPUT

It is recommended that a capacitor (about 0.33uF) be inserted between INPUT and COMMON.
 The value of capacitor is designed suitable for the actual application.

• OUTPUT

It is recommended that a capacitor (about 0.1uF) be inserted between OUTPUT and COMMON.
 A tantalum capacitor can also be used for this pin because insufficient capacitors may cause oscillation by a temperature change.

• COMMON

Keep the no voltage drop between Ground level of set board and IC.
 When there is the voltage difference, setting voltage becomes inaccuracy and unstable.
 It is recommended to connect by wide, short pattern, and lower the impedance.

●Notes for use

(1) Absolute Maximum Ratings

While utmost care is taken to quality control of this product, any application that may exceed some of the absolute maximum ratings including the voltage applied and the operating temperature range may result in breakage. If broken, short-mode or open-mode may not be identified. So if it is expected to encounter with special mode that may exceed the absolute maximum ratings, it is requested to take necessary safety measures physically including insertion of fuses.

(2) Ground voltage

Make setting of the potential of the GND terminal so that it will be maintained at the minimum in any operating state. Furthermore, check to be sure no terminals are at a potential lower than the GND voltage including an actual electric transient.

(3) Thermal design

When you do the kind of use which exceeds Pd, It may be happened to deteriorating IC original quality such as decrease of electric current ability with chip temperature rise. Do not exceed the power dissipation (Pd) of the package specification rating under actual operation, and please design enough temperature margins.

(4) Short-circuiting between terminals, and mismatching

When mounting to pc board, care must be taken to avoid mistake in its orientation and alignment. Failure to do so may result in IC breakdown. Short-circuiting due to foreign matters entered between output terminals, or between output and power supply or GND may also cause breakdown.

(5) Operation in Strong electromagnetic field

Be noted that using the IC in the strong electromagnetic radiation can cause operation failures.

(6) Inspection with the IC set to a pc board

If a capacitor must be connected to the pin of lower impedance during inspection with the IC set to a pc board, the capacitor must be discharged after each process to avoid stress to the IC. For electrostatic protection, provide proper grounding to assembling processes with special care taken in handling and storage. When connecting to jigs in the inspection process, be sure to turn OFF the power supply before it is connected and removed.

(7) Input to IC terminals

This is a monolithic IC with P⁺ isolation between P-substrate and each element as illustrated below. This P-layer and the N-layer of each element form a P-N junction, and various parasitic element are formed.

If a resistor is joined to a transistor terminal as shown in Fig 28.

OP-N junction works as a parasitic diode if the following relationship is satisfied;

GND>Terminal A (at resistor side), or GND>Terminal B (at transistor side); and

Of GND>Terminal B (at NPN transistor side),

a parasitic NPN transistor is activated by N-layer of other element adjacent to the above-mentioned parasitic diode.

The structure of the IC inevitably forms parasitic elements, the activation of which may cause interference among circuits, and/or malfunctions contributing to breakdown. It is therefore requested to take care not to use the device in such manner that the voltage lower than GND (at P-substrate) may be applied to the input terminal, which may result in activation of parasitic elements.

(8) Ground wiring pattern

If small-signal GND and large-current GND are provided, It will be recommended to separate the large-current GND pattern from the small-signal GND pattern and establish a single ground at the reference point of the set PCB so that resistance to the wiring pattern and voltage fluctuations due to a large current will cause no fluctuations in voltages of the small-signal GND. Pay attention not to cause fluctuations in the GND wiring pattern of external parts as well.

(9) Thermal shutdown circuit

A temperature control circuit is built in the IC to prevent the damage due to overheat. Therefore, the output is turned off when the thermal circuit works and is turned on when the temperature goes down to the specified level.

But, built-in the IC a temperature control circuit to protect itself, and avoid the design used the thermal protection.

(10) Over current protection circuit

The over-current protection circuits are built in at output, according to their respective current outputs and prevent the IC from being damaged when the load is short-circuited or over-current. But, these protection circuits are effective for preventing destruction by unexpected accident. When it's in continuous protection circuit moving period don't use please. And for ability, because this chip has minus characteristic, be careful for heat plan.

(11) There is a possibility to damage an internal circuit or the element when Vin and the voltage of each terminal reverse in the application. For instance, Vin is short-circuited to GND etc. with the charge charged to an external capacitor. Please use the capacitor of the output terminal with 1000μF or less. Moreover, the Vin series is recommended to insert the diode of the by-pass the diode of the backflow prevention or between each terminal and Vin.

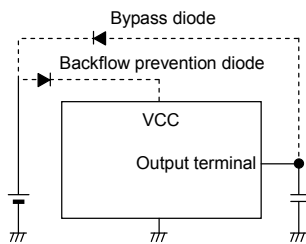

Fig.27 Bypass Diode

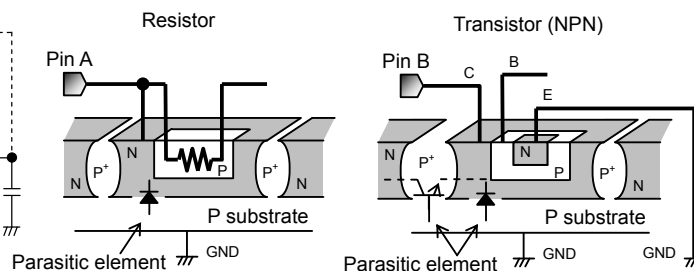
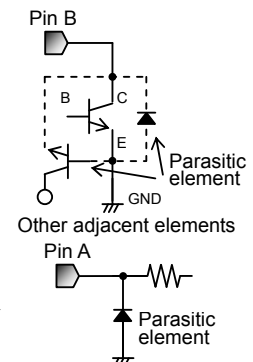

Fig.28 Simplified structure of monolithic IC



Notes

No copying or reproduction of this document, in part or in whole, is permitted without the consent of ROHM Co.,Ltd.

The content specified herein is subject to change for improvement without notice.

The content specified herein is for the purpose of introducing ROHM's products (hereinafter "Products"). If you wish to use any such Product, please be sure to refer to the specifications, which can be obtained from ROHM upon request.

Examples of application circuits, circuit constants and any other information contained herein illustrate the standard usage and operations of the Products. The peripheral conditions must be taken into account when designing circuits for mass production.

Great care was taken in ensuring the accuracy of the information specified in this document. However, should you incur any damage arising from any inaccuracy or misprint of such information, ROHM shall bear no responsibility for such damage.

The technical information specified herein is intended only to show the typical functions of and examples of application circuits for the Products. ROHM does not grant you, explicitly or implicitly, any license to use or exercise intellectual property or other rights held by ROHM and other parties. ROHM shall bear no responsibility whatsoever for any dispute arising from the use of such technical information.

The Products specified in this document are intended to be used with general-use electronic equipment or devices (such as audio visual equipment, office-automation equipment, communication devices, electronic appliances and amusement devices).

The Products specified in this document are not designed to be radiation tolerant.

While ROHM always makes efforts to enhance the quality and reliability of its Products, a Product may fail or malfunction for a variety of reasons.

Please be sure to implement in your equipment using the Products safety measures to guard against the possibility of physical injury, fire or any other damage caused in the event of the failure of any Product, such as derating, redundancy, fire control and fail-safe designs. ROHM shall bear no responsibility whatsoever for your use of any Product outside of the prescribed scope or not in accordance with the instruction manual.

The Products are not designed or manufactured to be used with any equipment, device or system which requires an extremely high level of reliability the failure or malfunction of which may result in a direct threat to human life or create a risk of human injury (such as a medical instrument, transportation equipment, aerospace machinery, nuclear-reactor controller, fuel-controller or other safety device). ROHM shall bear no responsibility in any way for use of any of the Products for the above special purposes. If a Product is intended to be used for any such special purpose, please contact a ROHM sales representative before purchasing.

If you intend to export or ship overseas any Product or technology specified herein that may be controlled under the Foreign Exchange and the Foreign Trade Law, you will be required to obtain a license or permit under the Law.



Thank you for your accessing to ROHM product informations.
More detail product informations and catalogs are available, please contact us.

ROHM Customer Support System

<http://www.rohm.com/contact/>