

Model P230
24mm Rotary Potentiometer
Conductive Plastic Element
500,000 Cycle Life
Metal Shaft
Brass Bushing
RoHS Compliant



MODEL STYLE

Side Adjust , Solder Lugs

P230

ELECTRICAL¹

Resistance Range, Ohms	500-1M
Standard Resistance Tolerance	± 20%
Residual Resistance	20 ohms max.
Input Voltage, maximum	500 Vac max.
Power rating, Watts	0.5W- B taper, 0.25W-others
Dielectric Strength	500Vac, 1 minute
Insulation Resistance, Minimum	100M ohms at 250Vdc
Sliding Noise	100mV max.
Actual Electrical Travel, Nominal	270°

MECHANICAL

Total Mechanical Travel	300°± 10°
Static Stop Strength	70 oz-in
Rotational Torque, Maximum	1.0 oz-in

ENVIRONMENTAL

Operating Temperature Range	-20°C to +70°C
Rotational Life	500,000 cycles

¹ Specifications subject to change without notice.

Model P230

ORDERING INFORMATION²

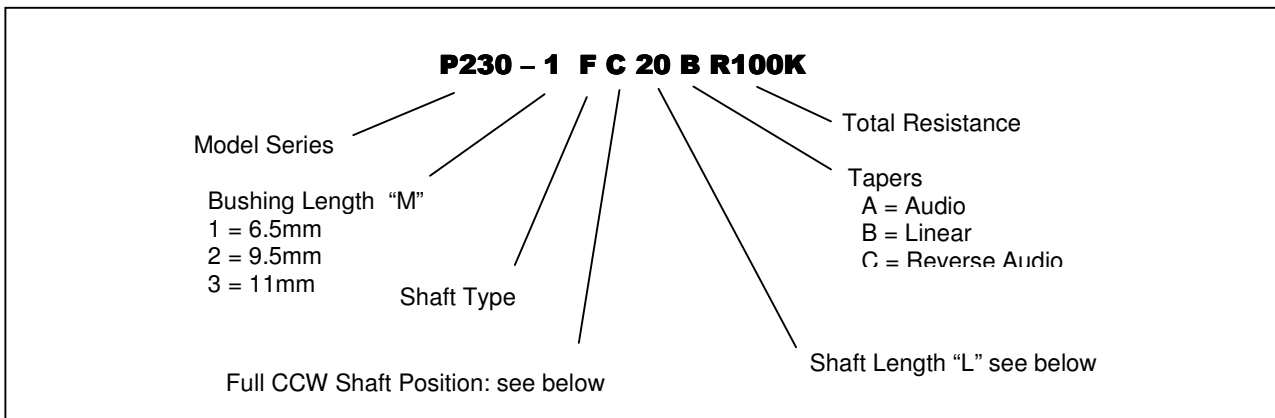

Shaft Types

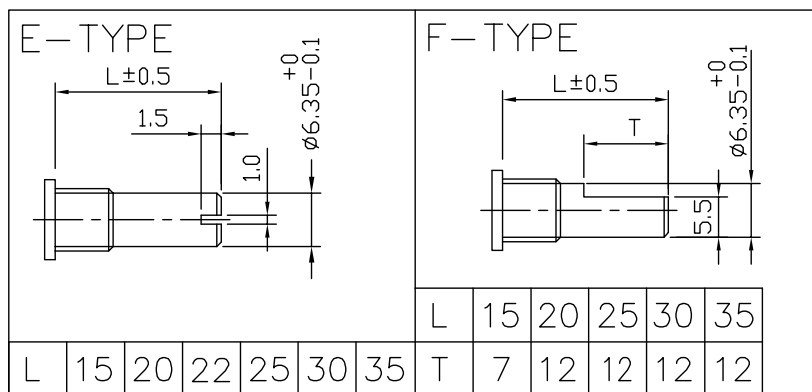

Shaft Position (F-Type Shaft)

Dashed lines on Type "C" and Type "A" shows position of adjustment slot for E-Type shaft

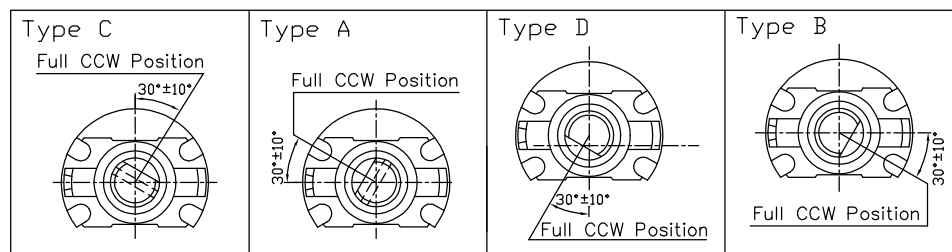

STANDARD RESISTANCE VALUES, OHMS

500 1K 2K 5K 10K 20K 50K 100K 200K 500K 1MEG

² Contact our customer service for custom designs and features.

Model P230

OUTLINE DRAWING

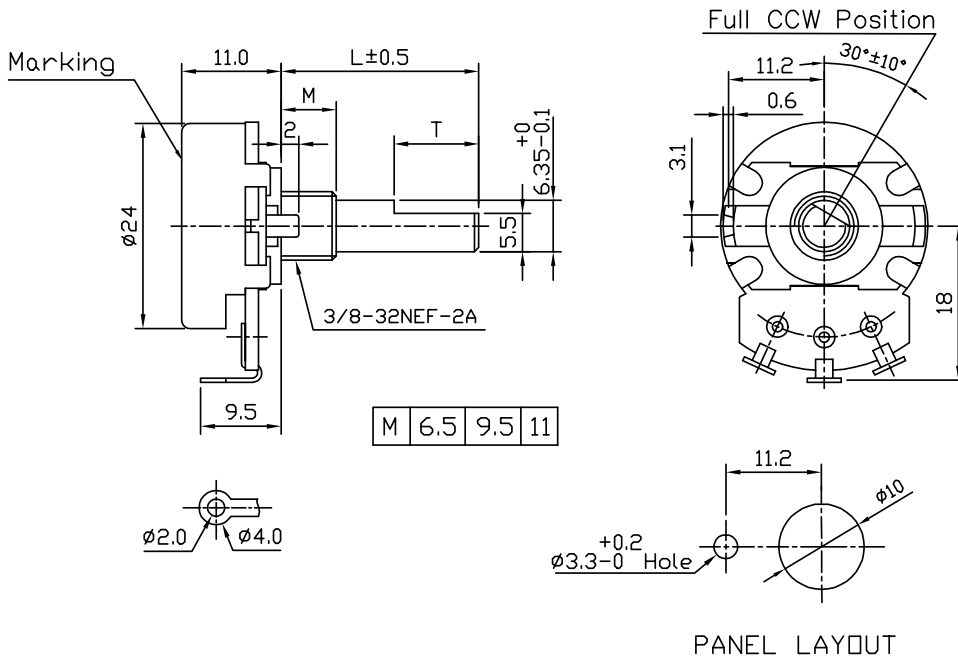

CIRCUIT DIAGRAM

