

Pb-free
HEAT

STANLEY

1111C Series

Single Color Low Current Type ($I_F=5\text{mA}$)

Features

Package	1608(t=0.7mm)Type, Milky White Resin
Product Features	<ul style="list-style-type: none"> • Outer Dimension 1.6 x 0.8 x 0.7mm (L x W x H) • Low Current Type ($I_F=5\text{mA}$) • Temperature Range Storage Temperature : $-40^{\circ}\text{C}\sim 100^{\circ}\text{C}$ Operating Temperature : $-40^{\circ}\text{C}\sim 85^{\circ}\text{C}$ • Lead-Free Soldering compatible • RoHS Compliant
Dominant Wavelength	Blue : 470nm(SB) Green : 525nm(SG) Yellow Green : 572nm(YPY) Yellow : 590nm(FY) Orange : 605nm(FA) Red : 626nm(FR)
Half Intensity Angle	SB, SG : $\theta_x = 150 \text{ deg.}, \theta_y = 150 \text{ deg.}$ YPY,FY, FA, FR : $\theta_x = 140 \text{ deg.}, \theta_y = 150 \text{ deg.}$
Die Materials	SB,SG : InGaN YPY, FY, FA, FR : AlGaInP
Rank Grouping Parameter	Sorted by luminous Intensity and wavelength per rank taping
Assembly method	Auto pick & place machine (Auto Mounter)
Soldering methods	Reflow soldering / Manual Soldering
Taping and reel	4,000pcs per reel in a 8mm width tape. (Standard) Reel diameter: $\phi 180\text{mm}$
ESD	InGaN : Up to 1kV (HBM), AlGaInP : Up to 2kV (HBM)

Recommended Applications

Communication Machine, Electric Household Appliances, OA/FA, Other General Applications

Color and Luminous Intensity

(Ta=25°C)

Part No.	Material	Emitted Color	Lens Color	Dominant Wavelength		Luminous Intensity		
				λd (nm)		I_v (mcd)		
				TYP.	I_f (mA)	MIN.	TYP.	I_f (mA)
SB1111C-0005	InGaN	Blue	Milkey White	470	5	10	20	5
SG1111C-0005	InGaN	Green		530	5	33	90	5
YPY1111C-0005	AlGaInP	Yellow Green		572	5	4	12	5
FY1111C-0105	AlGaInP	Yellow		590	5	10	30	5
FA1111C-0105	AlGaInP	Orange		605	5	10	35	5
FR1111C-0105	AlGaInP	Red		626	5	10	30	5

Absolute Maximum Ratings

(Ta=25°C)

Item	Symbol	Absolute Maximum Ratings		Unit
		SB	SG	
Power Dissipation	P_d	55	78	mW
Continuous Forward Current	I_F	15	20	mA
Repetitive Peak Forward Current ^{*1}	I_{FRM}	48	48	mA
Derating (Ta=25°C or higher)	ΔI_F	0.20	0.26	mA/°C
	ΔI_{FRM}	0.64	0.64	mA/°C
Reverse Voltage	V_R	5	5	V
Operating Temperature	T_{opr}	-40~+85		°C
Storage Temperature	T_{stg}	-40~+100		°C

Item	Symbol	Absolute Maximum Ratings				Unit
		YPY	FY	FA	FR	
Power Dissipation	P_d	36	36	36	36	mW
Continuous Forward Current	I_F	15	15	15	15	mA
Repetitive Peak Forward Current ^{*1}	I_{FRM}	48	48	48	48	mA
Derating (Ta=60°C or higher)	ΔI_F	0.43	0.43	0.43	0.43	mA/°C
	ΔI_{FRM}	1.37	1.37	1.37	1.37	mA/°C
Reverse Voltage	V_R	5	5	5	5	V
Operating Temperature	T_{opr}	-40~+85				°C
Storage Temperature	T_{stg}	-40~+100				°C

^{*1} I_{FRM} Measurement Condition : Pulse Width $\leq 1\text{ms.}$, Duty $\leq 1/20$

Electro-Optical Characteristics (SB,SG)

(Ta=25°C)

Item	Conditions	Symbol	Characteristics		Unit	
			SB	SG		
Forward Voltage	$I_f=5\text{mA}$	V_F	TYP.	2.9	3.0	V
			MAX.	3.2	3.2	
Reverse Current	$V_R=5\text{V}$	I_R	MAX.	100	100	μA
Peak Wavelength	$I_f=5\text{mA}$	λ_p	TYP.	465	525	nm
Dominant Wavelength	$I_f=5\text{mA}$	λ_d	TYP.	470	530	nm
Spectral Line Half Width	$I_f=5\text{mA}$	$\Delta\lambda$	TYP.	15	30	nm
Half Intensity Angle※	$I_f=5\text{mA}$	$2\theta_{1/2}$	TYP.	$150(\theta_x)$	$150(\theta_x)$	deg.
				$150(\theta_y)$	$150(\theta_y)$	

 ※ θ_x : Product long side axis, θ_y : Product short side axis

Electro-Optical Characteristics (YPY,FY,FA,FR)

(Ta=25°C)

Item	Conditions	Symbol	Characteristics				Unit	
			YPY	FY	FA	FR		
Forward Voltage	$I_f=5\text{mA}$	V_F	TYP.	1.95	1.93	1.88	1.85	V
			MAX.	2.4	2.4	2.4	2.4	
Reverse Current	$V_R=5\text{V}$	I_R	MAX.	100	100	100	100	μA
Peak Wavelength	$I_f=5\text{mA}$	λ_p	TYP.	575	592	609	635	nm
Dominant Wavelength	$I_f=5\text{mA}$	λ_d	TYP.	572	590	605	626	nm
Spectral Line Half Width	$I_f=5\text{mA}$	$\Delta\lambda$	TYP.	15	15	15	15	nm
Half Intensity Angle※	$I_f=5\text{mA}$	$2\theta_{1/2}$	TYP.	$140(\theta_x)$	$140(\theta_x)$	$140(\theta_x)$	$140(\theta_x)$	deg.
				$150(\theta_y)$	$150(\theta_y)$	$150(\theta_y)$	$150(\theta_y)$	

 ※ θ_x : Product long side axis, θ_y : Product short side axis

Luminous Intensity Rank (Unit : mcd)

(Ta=25°C)

Tolerance : +/-10%

Rank	I_V (mcd)			
	SB		SG	
	$I_F=5\text{mA}$		$I_F=5\text{mA}$	
	MIN.	MAX.	MIN.	MAX.
BA	10	15	/	
BB	15	22		
BC	22	33		
BD	33	47	33	47
BE	47	-	47	68
BF	/		68	100
CA			100	150
CB			150	220

Rank	I_V (mcd)							
	YPY		FY		FA		FR	
	$I_F=5\text{mA}$		$I_F=5\text{mA}$		$I_F=5\text{mA}$		$I_F=5\text{mA}$	
	MIN.	MAX.	MIN.	MAX.	MIN.	MAX.	MIN.	MAX.
A	4	6.3	/		/		/	
B	6.3	10						
C	10	16	16	25	16	25	16	25
D	16	25	25	40	25	40	25	40
E	25	-	40	64	40	64	40	64
F	/		64	-	64	-	64	-

※ Please contact our sales staff concerning rank designation.

Color Tone Groups (λ d)

 (T_a=25°C)

Tolerance : +/-3nm

Rank	Dominant Wavelength λ d (nm)			
	SB		SG	
	I _F =5mA		I _F =5mA	
	MIN.	MAX.	MIN.	MAX.
2	465	470	520	532
3	470	475	532	545

Rank	Dominant Wavelength λ d (nm)							
	YPY		FY		FA		FR	
	I _F =5mA		I _F =5mA		I _F =5mA		I _F =5mA	
	MIN.	MAX.	MIN.	MAX.	MIN.	MAX.	MIN.	MAX.
A	566	569	581.5	585.0	596.1	600.9	621	632
B	569	572	584.0	587.5	599.1	603.9	/	
C	572	575	586.5	590.0	602.1	606.9		
D	575	578	589.0	592.5	605.1	609.9		
E	/		591.5	595.0	608.1	612.9		
F			594.0	597.5	/			

※ Please contact our sales staff concerning rank designation.

Technical Data (SB)

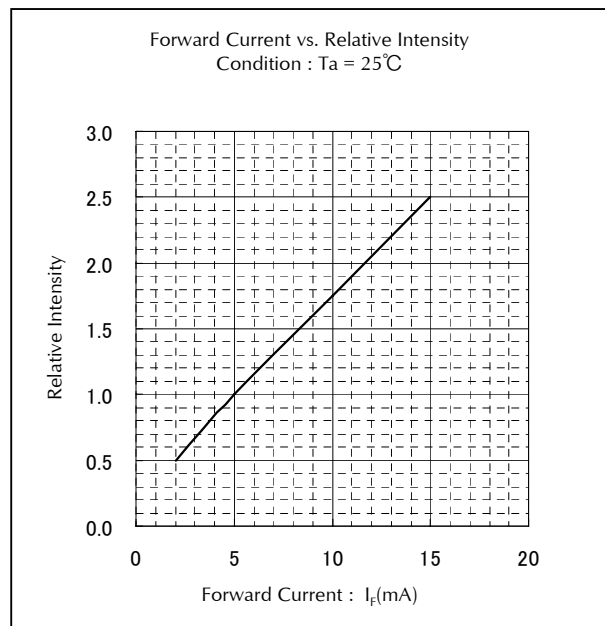
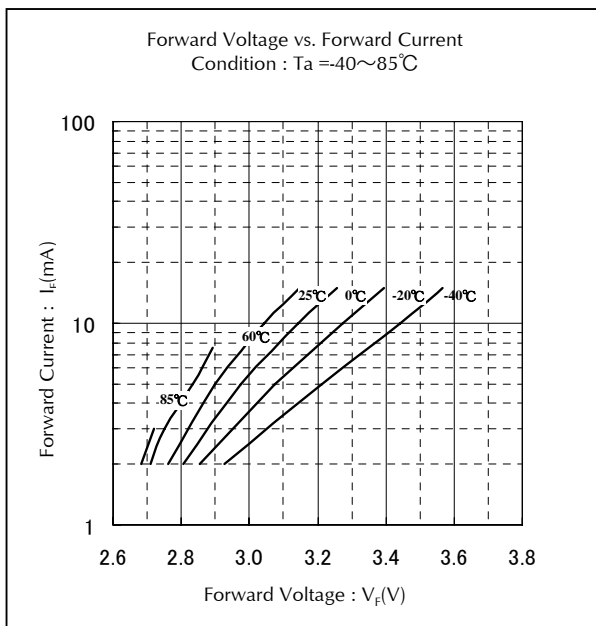
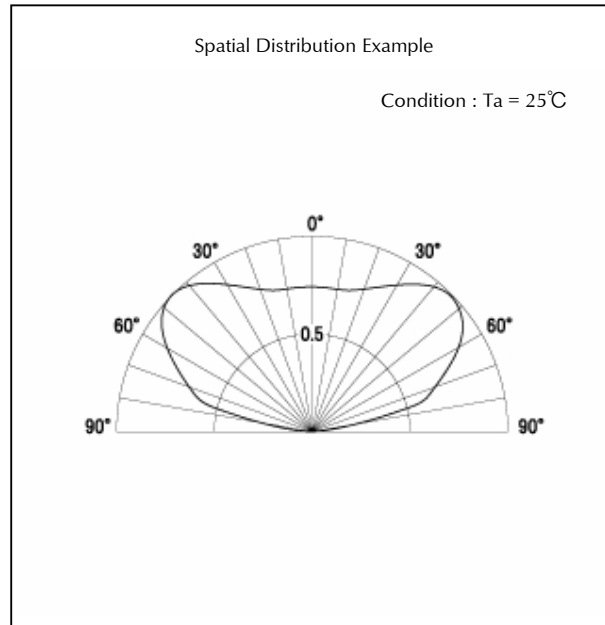
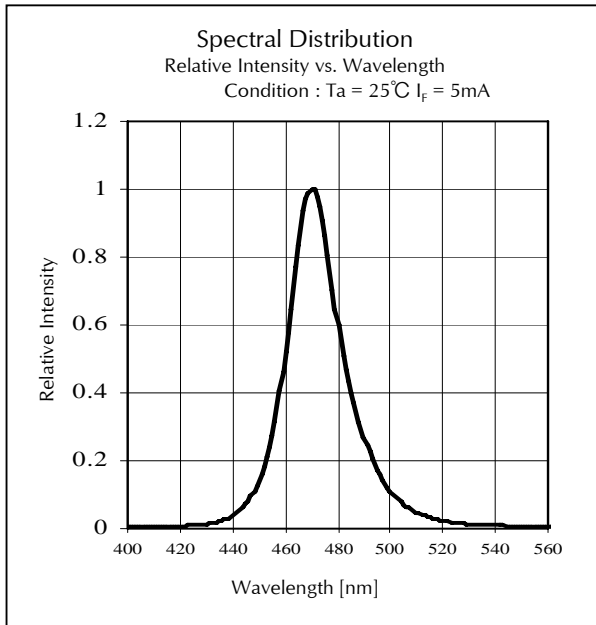

Technical Data (SB)

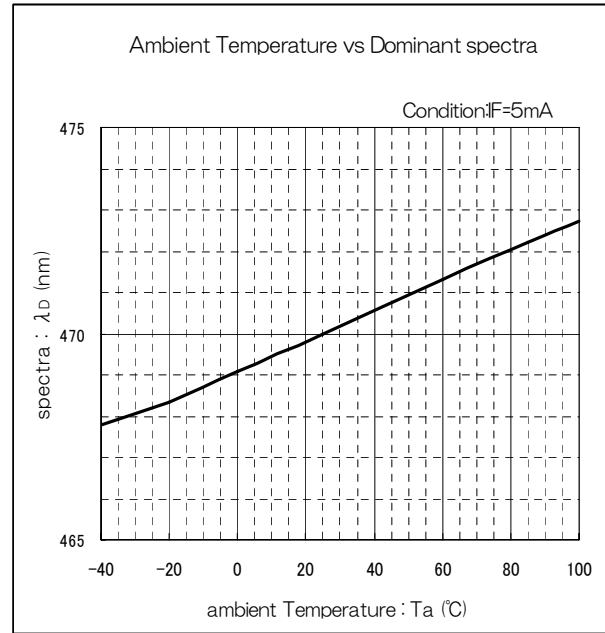
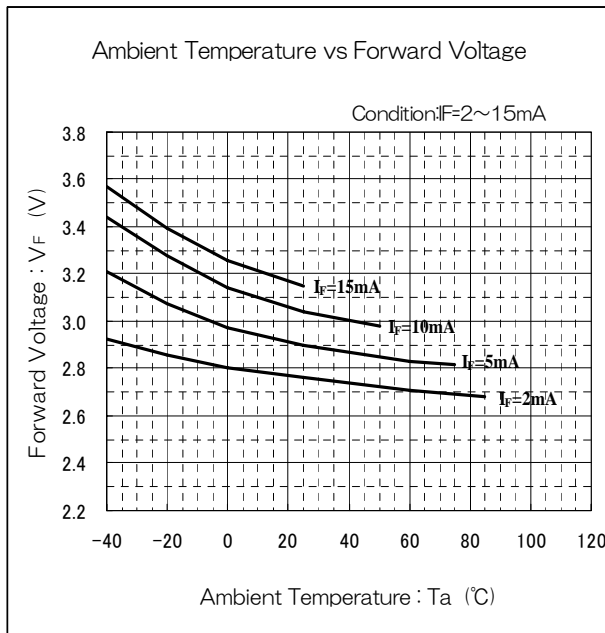
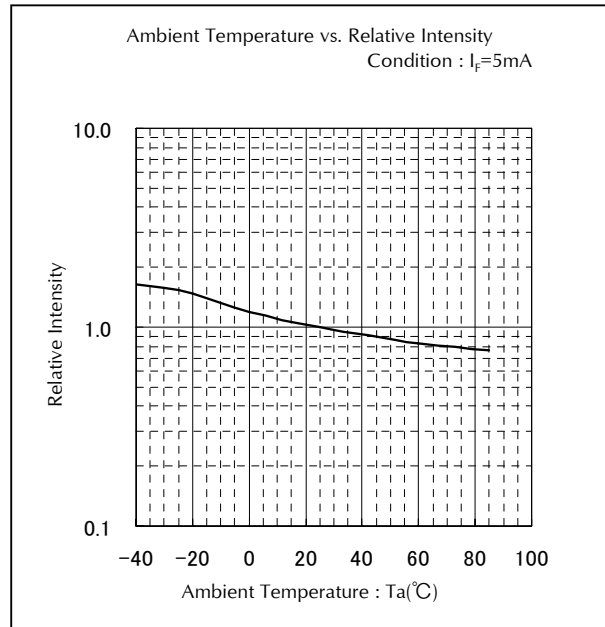
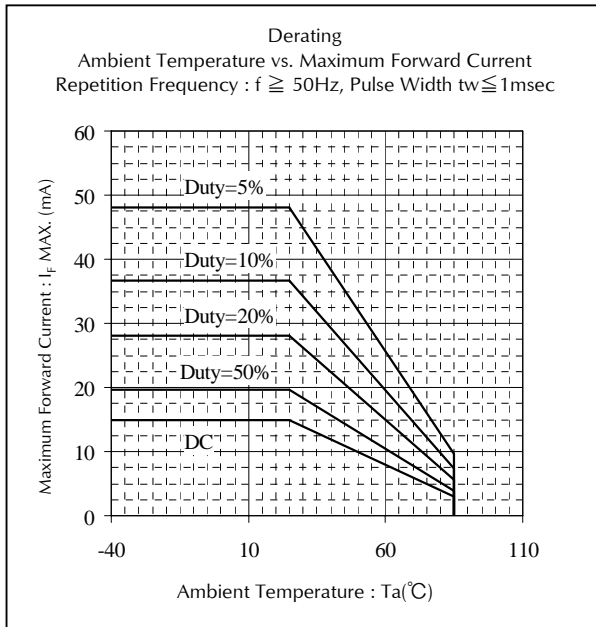

Technical Data (SB)

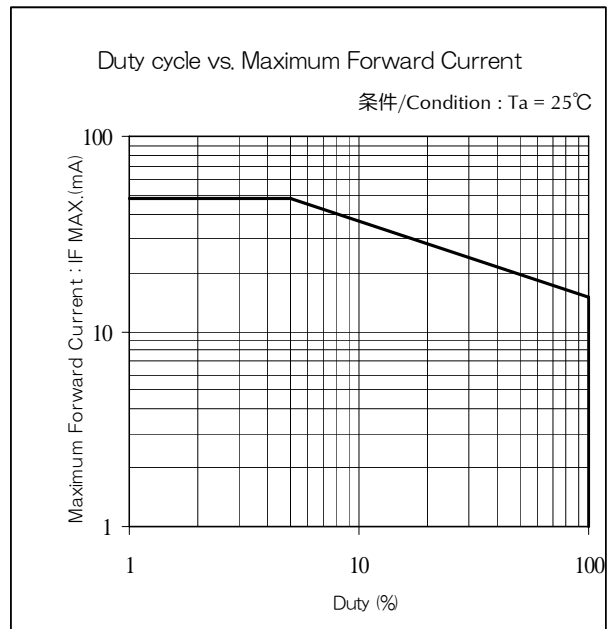
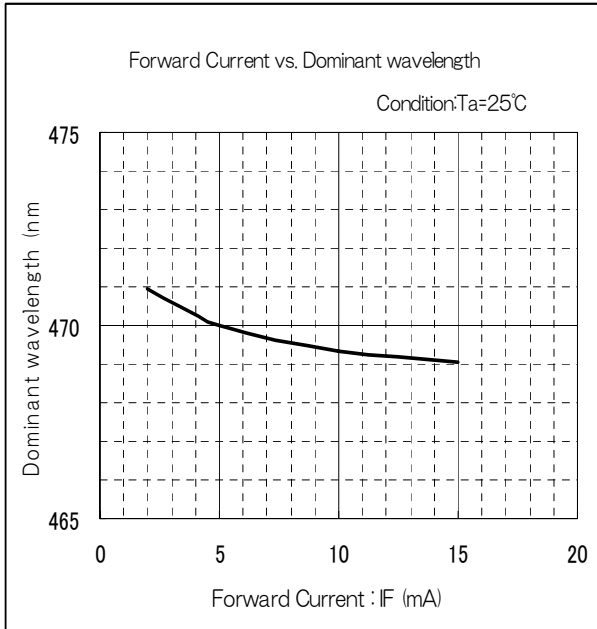

Technical Data (SB)

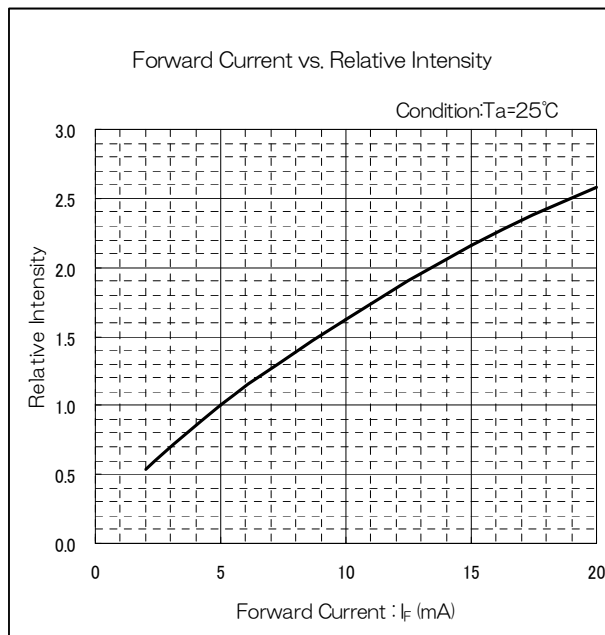
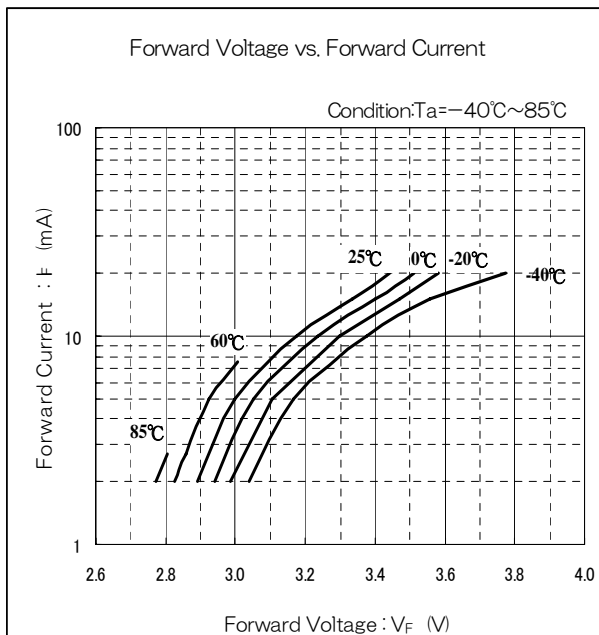
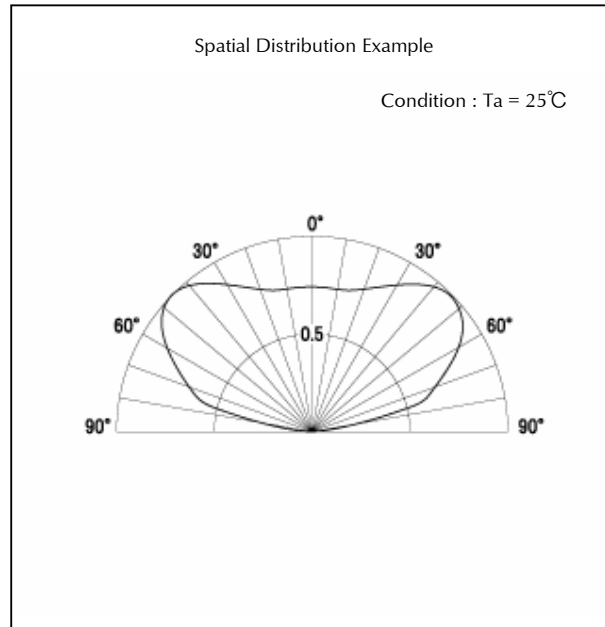
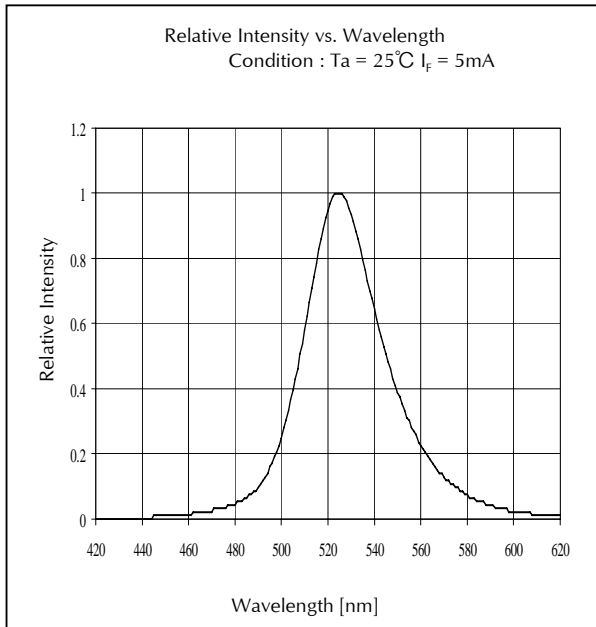

Technical Data (SG)

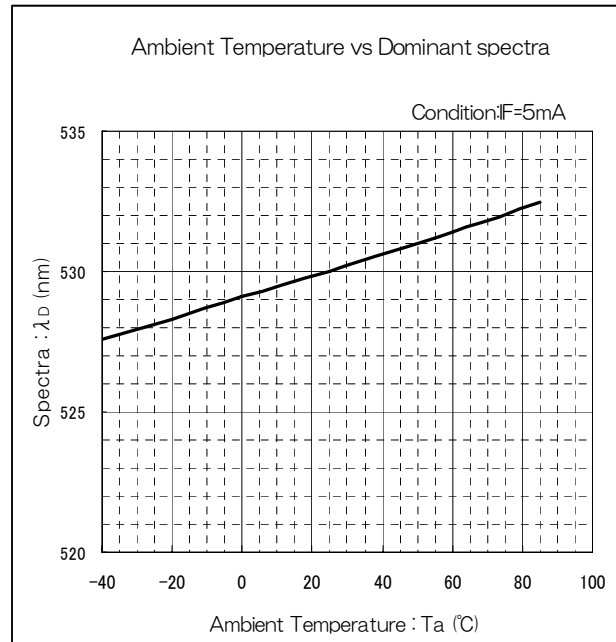
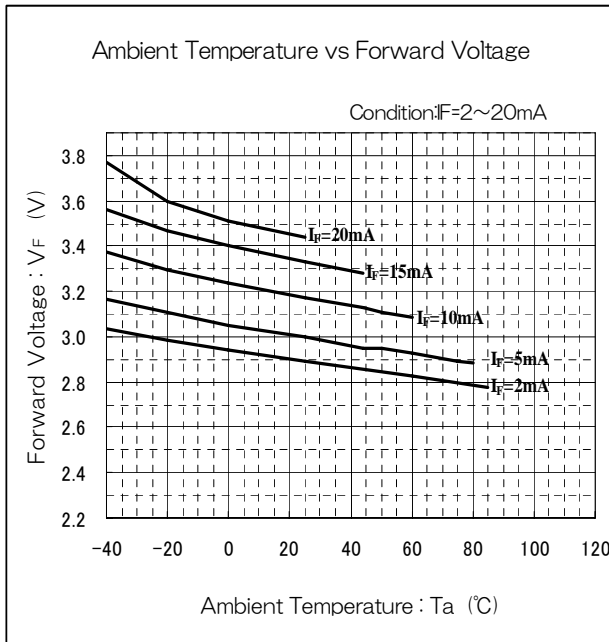
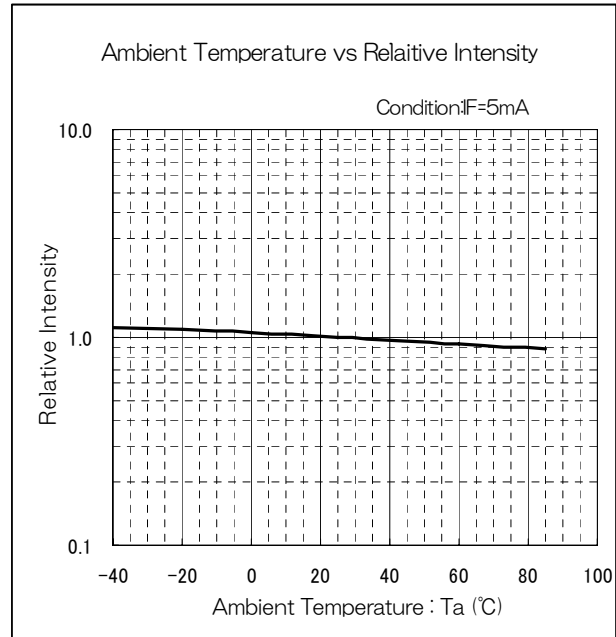
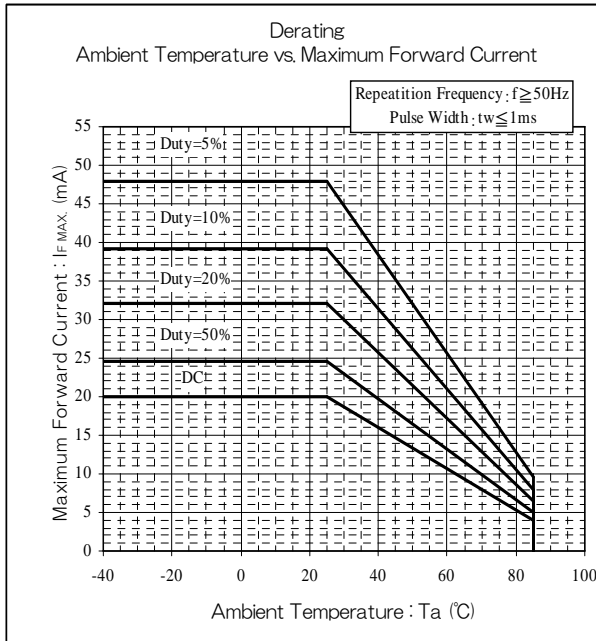

Technical Data (SG)

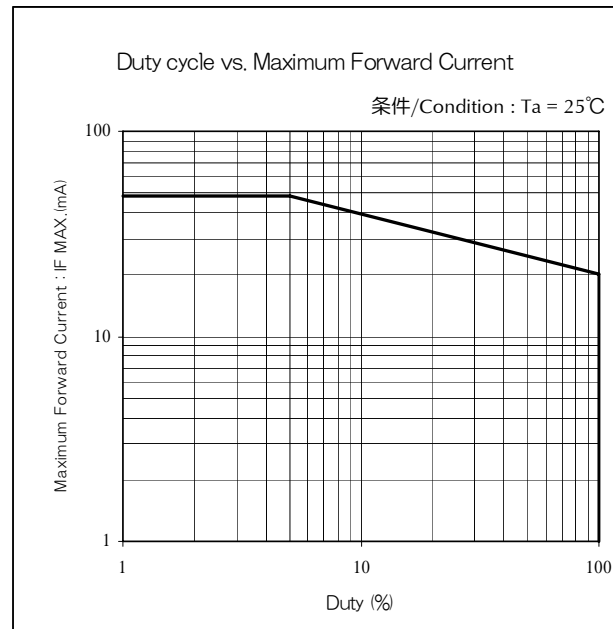
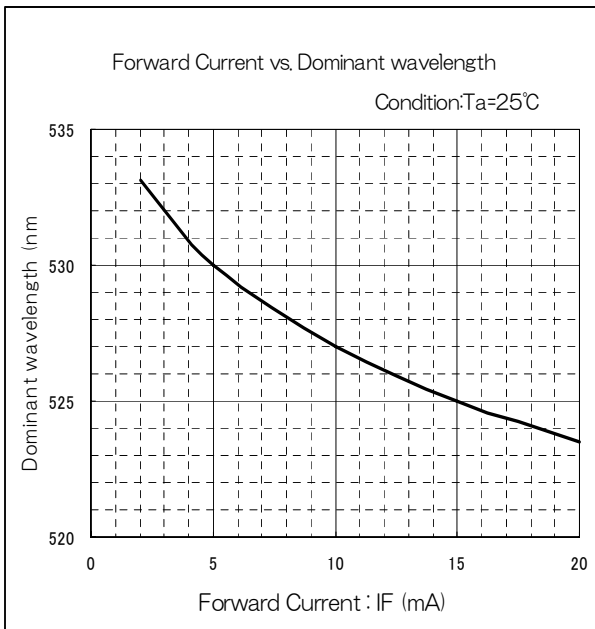

Technical Data (YPY)

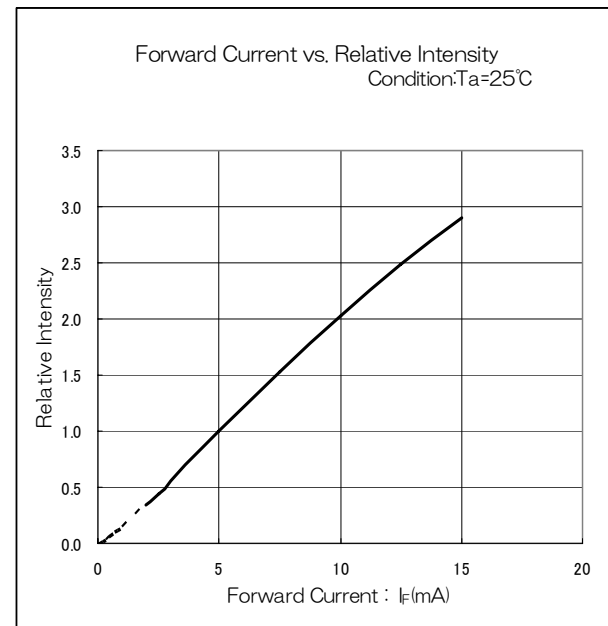
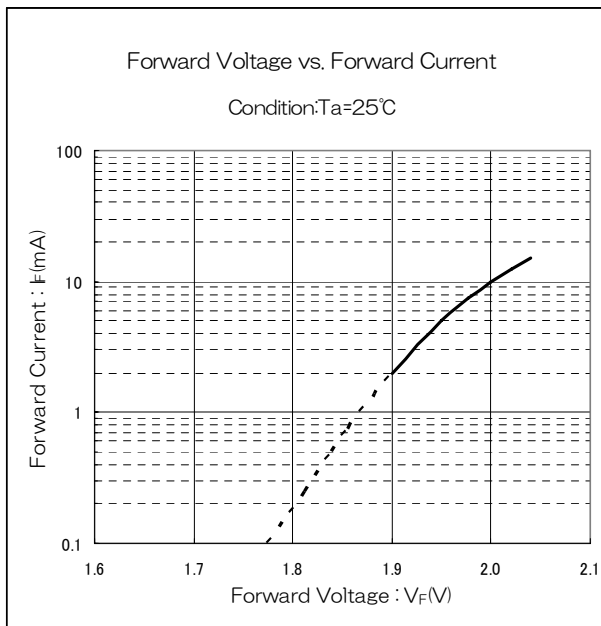
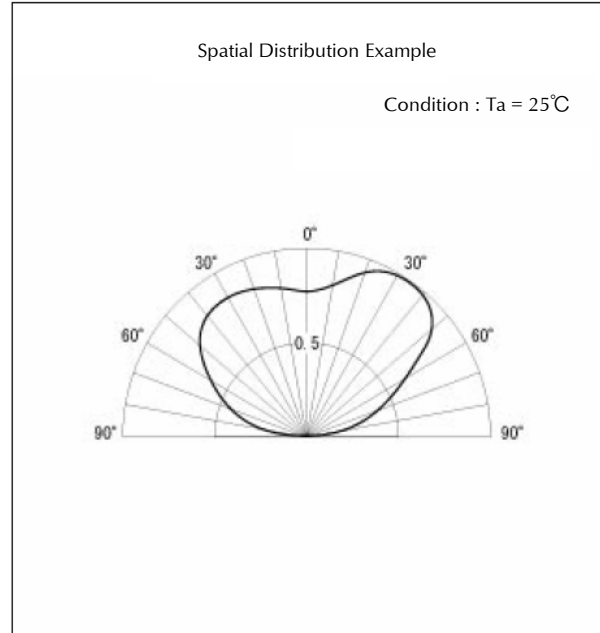
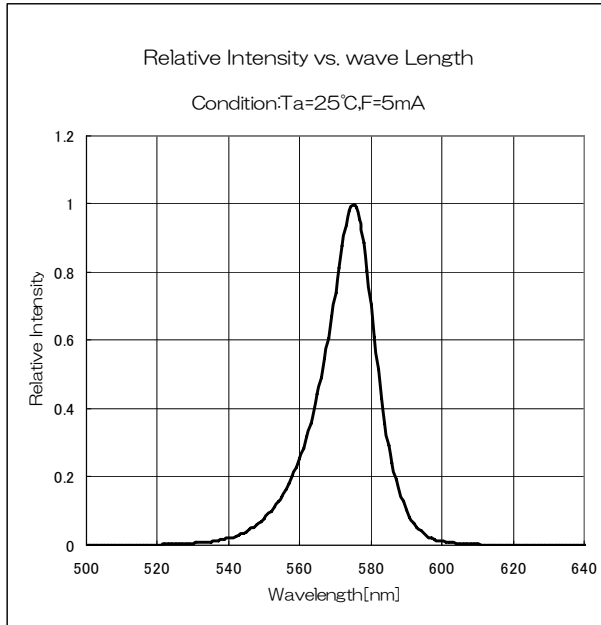

Technical Data (YPY)

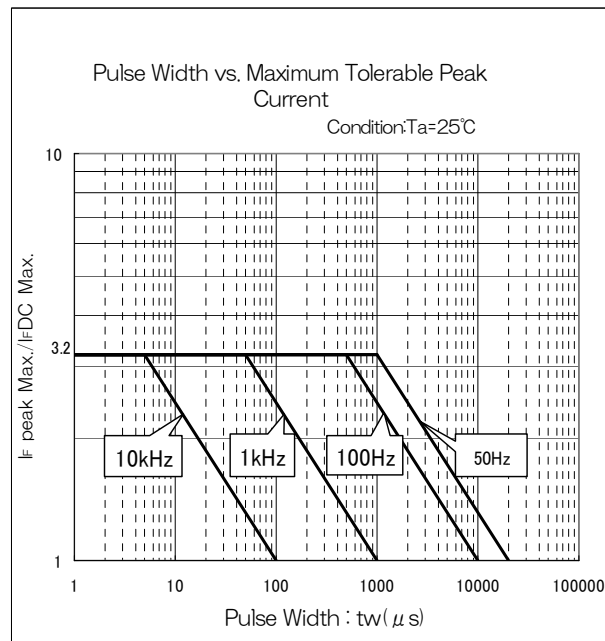
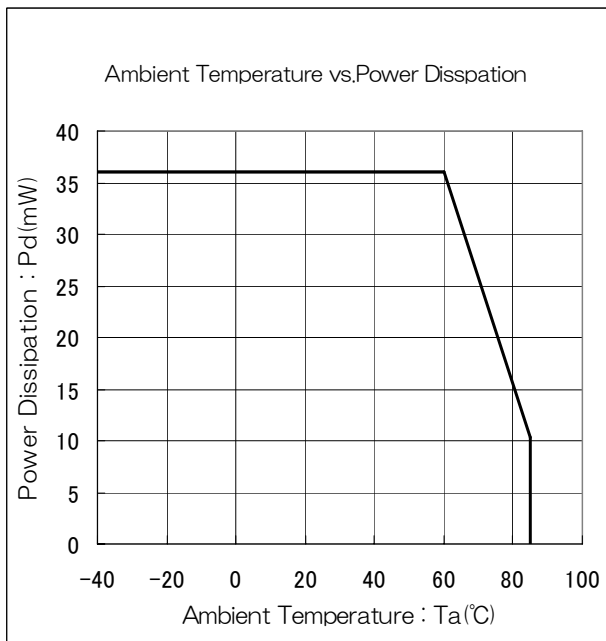
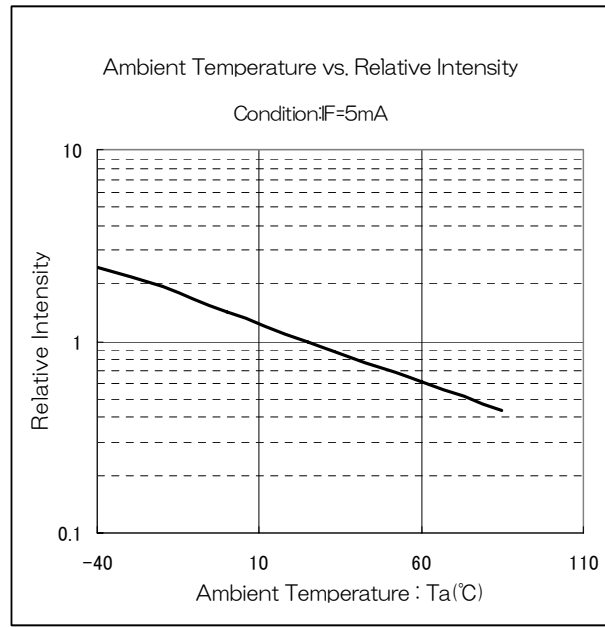
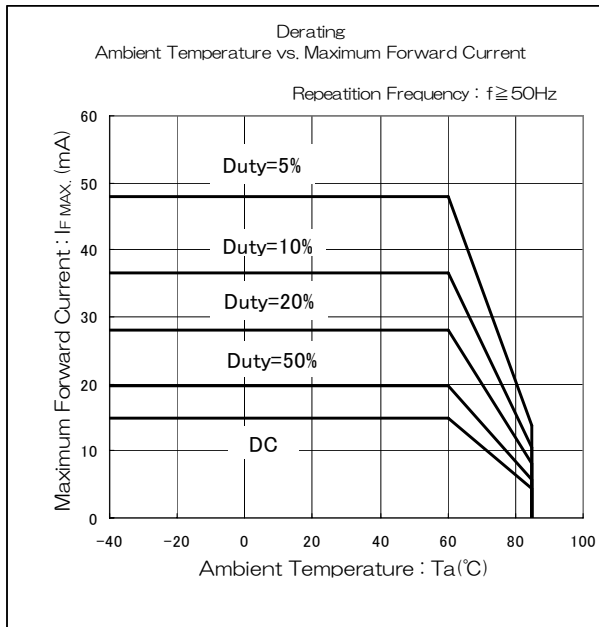

Technical Data (FY)

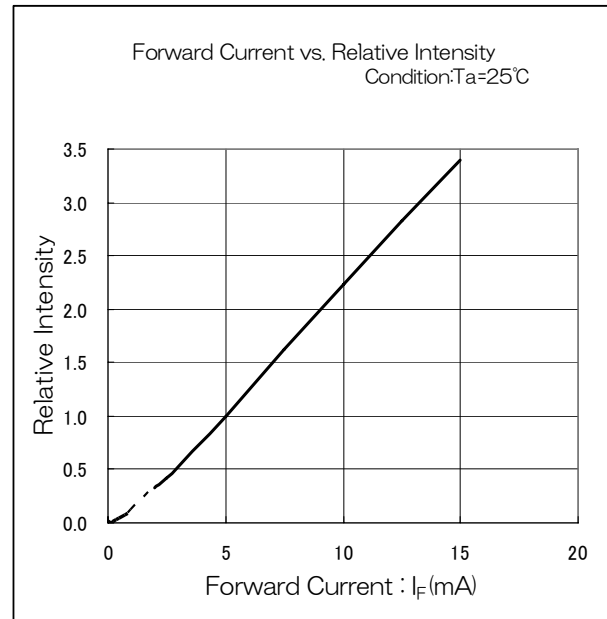
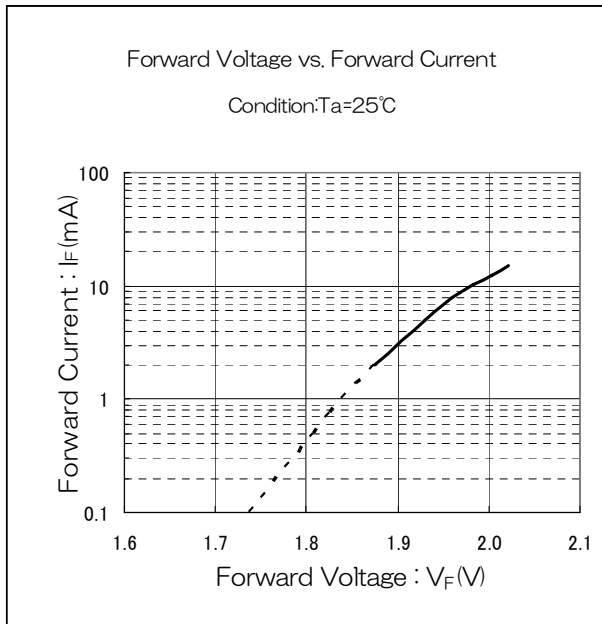
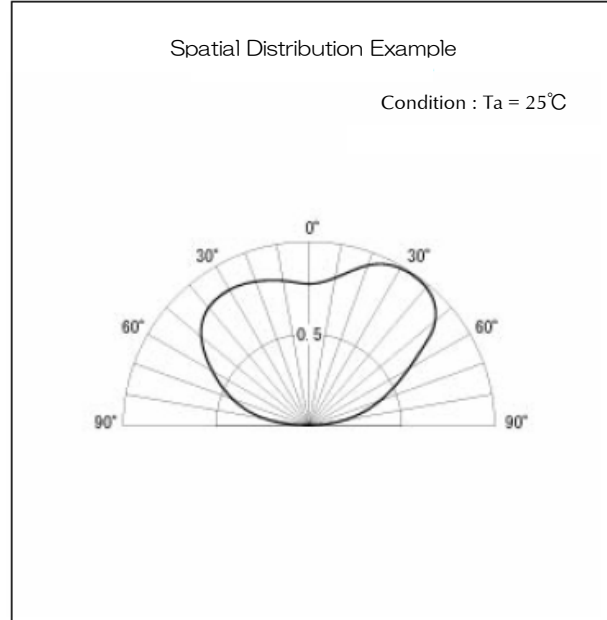
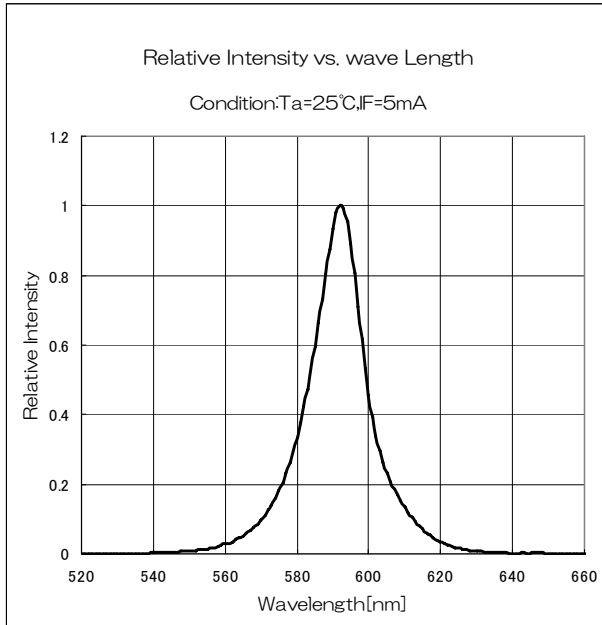

Technical Data (FY)

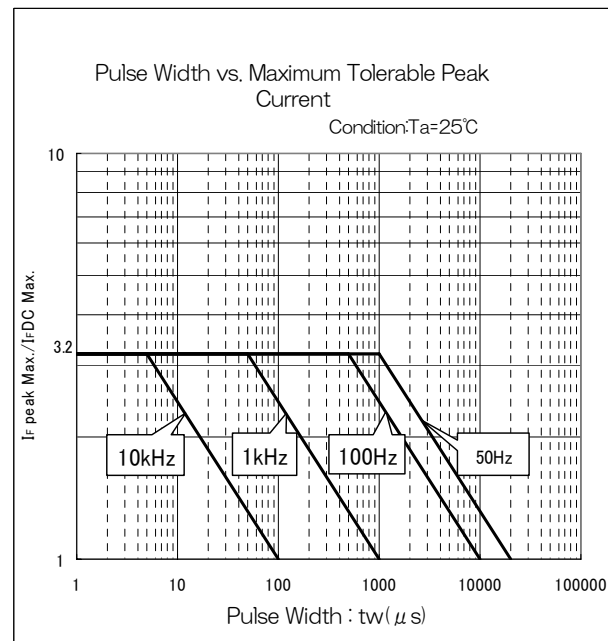
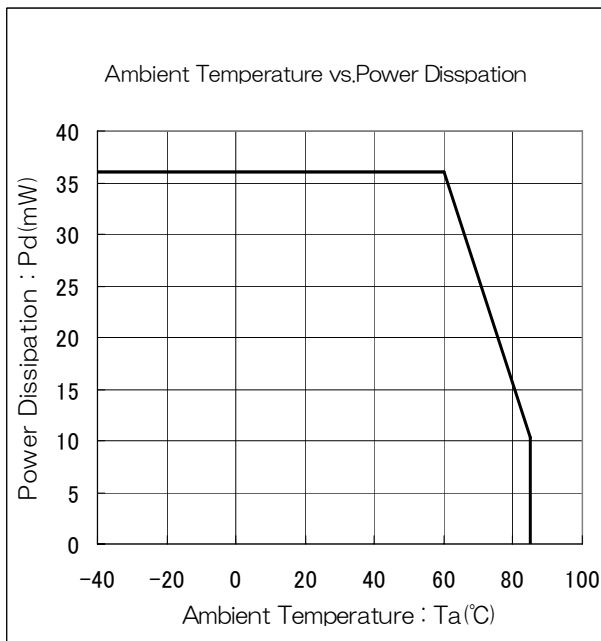
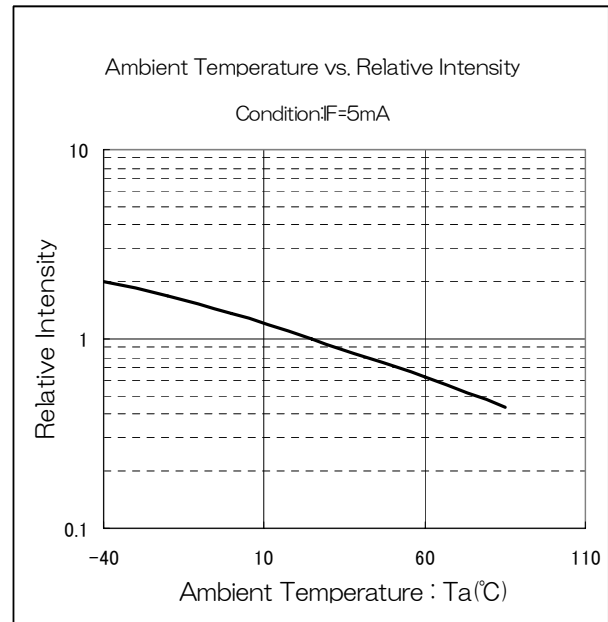
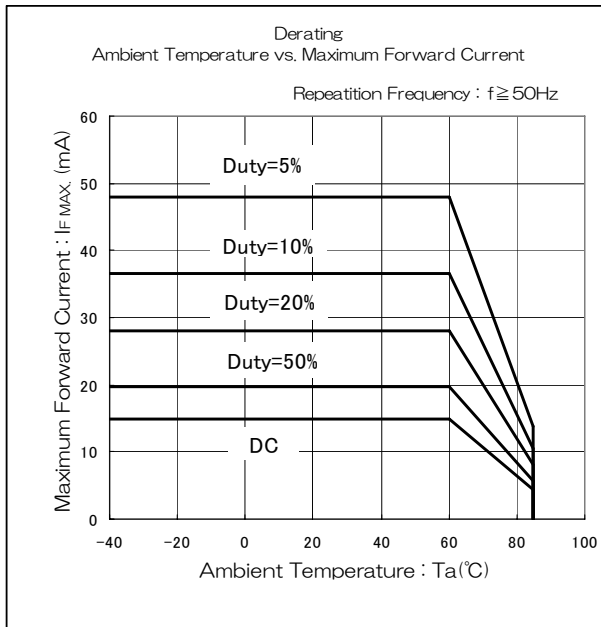

Technical Data (FA)

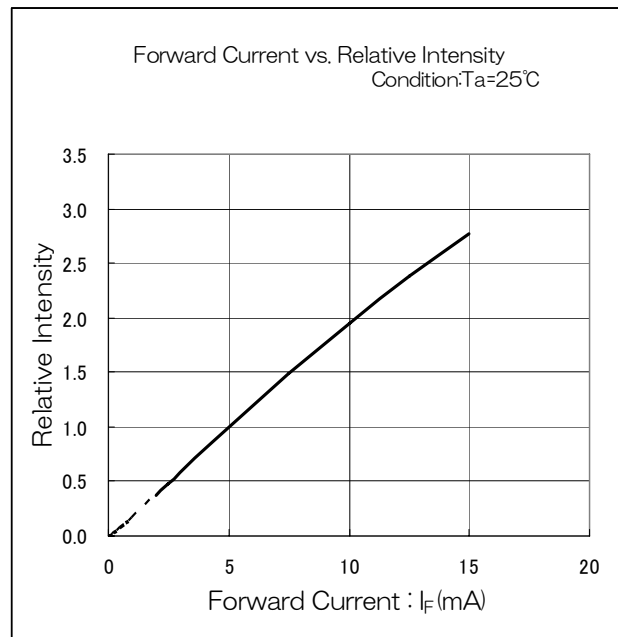
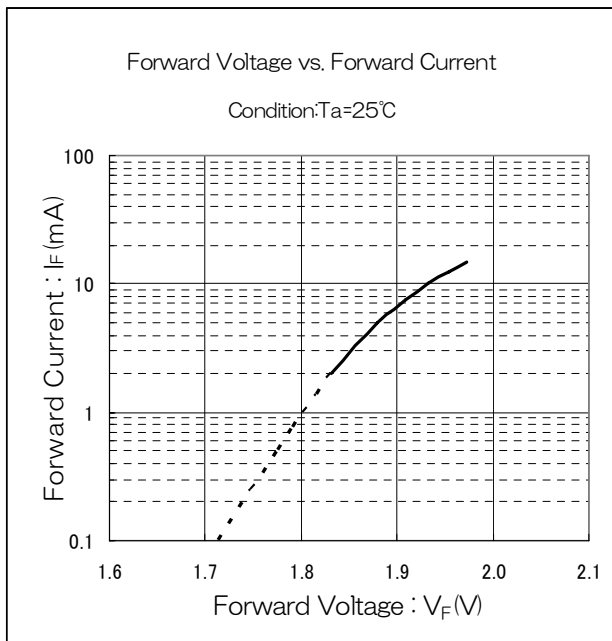
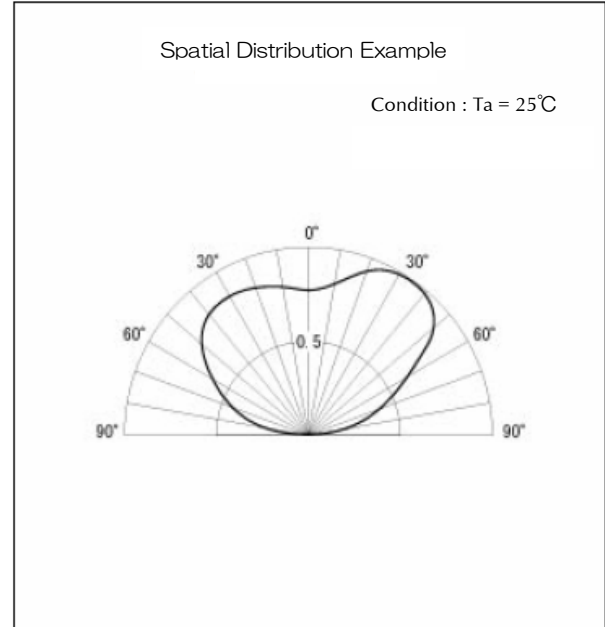
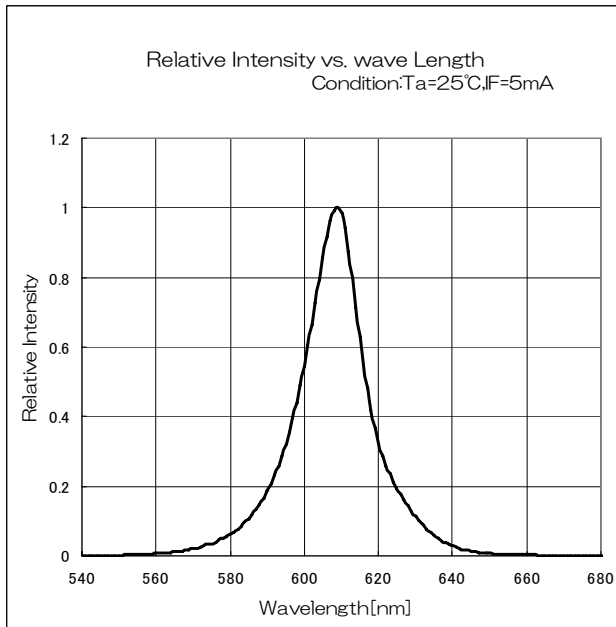

Technical Data (FA)

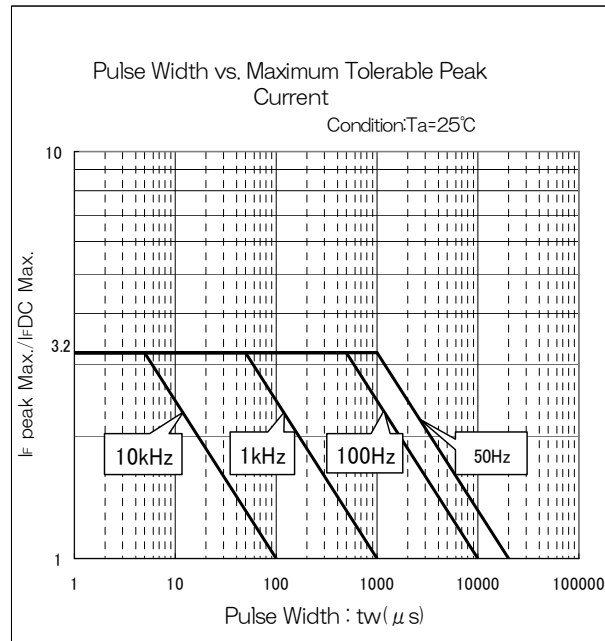
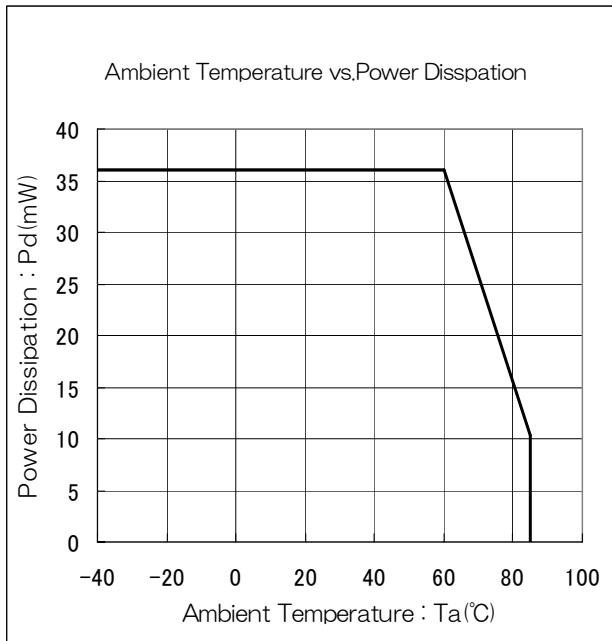
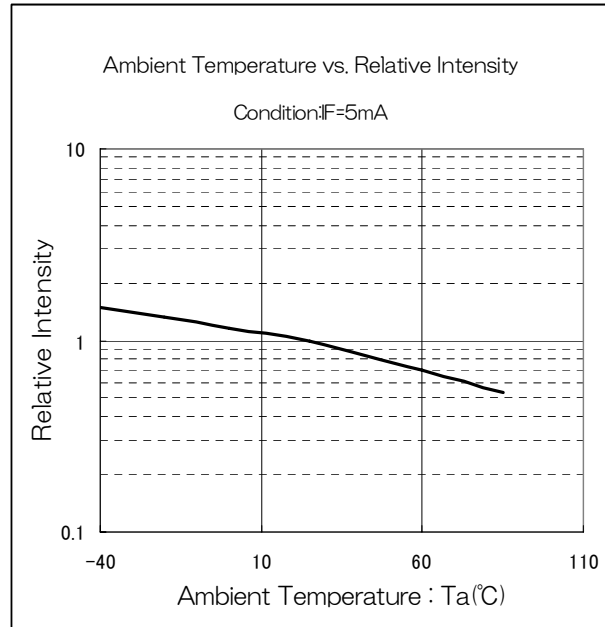
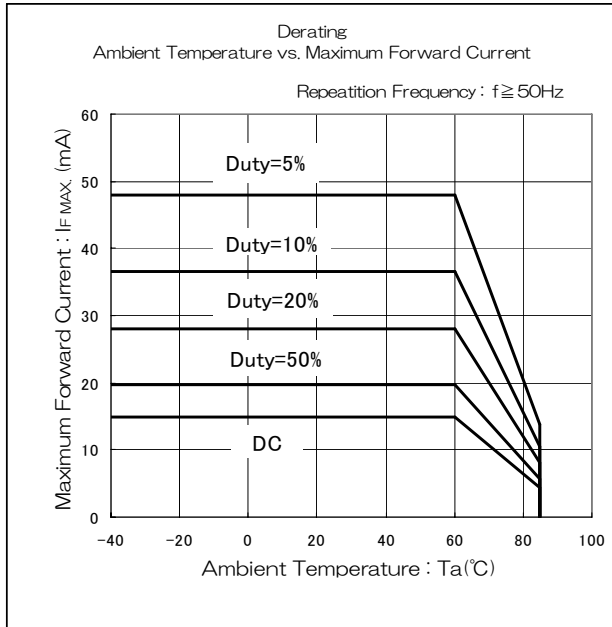

Technical Data (FR)

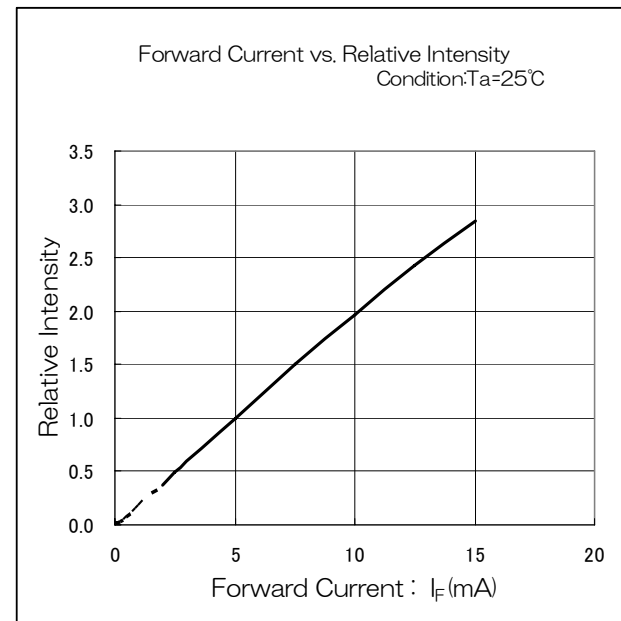
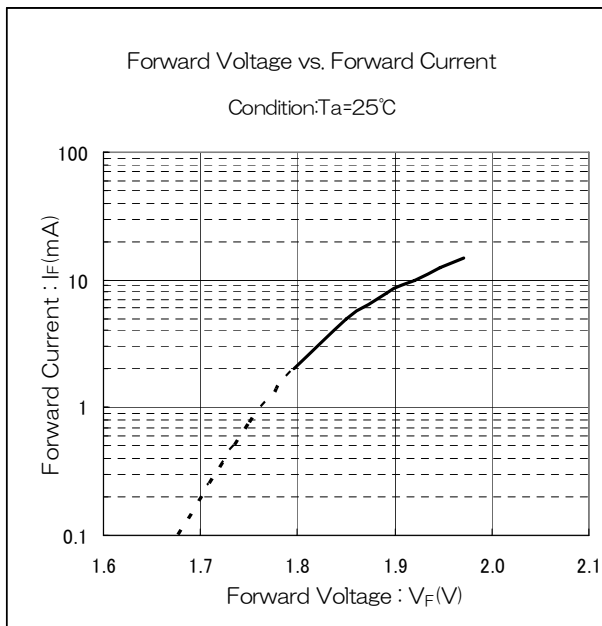
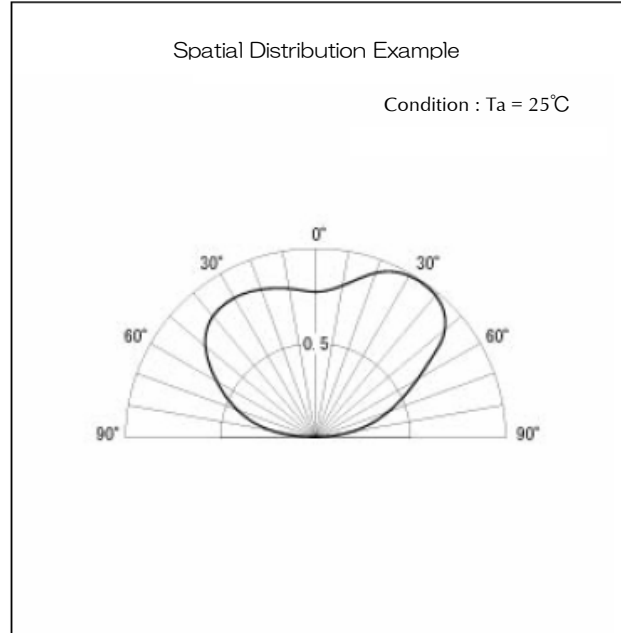
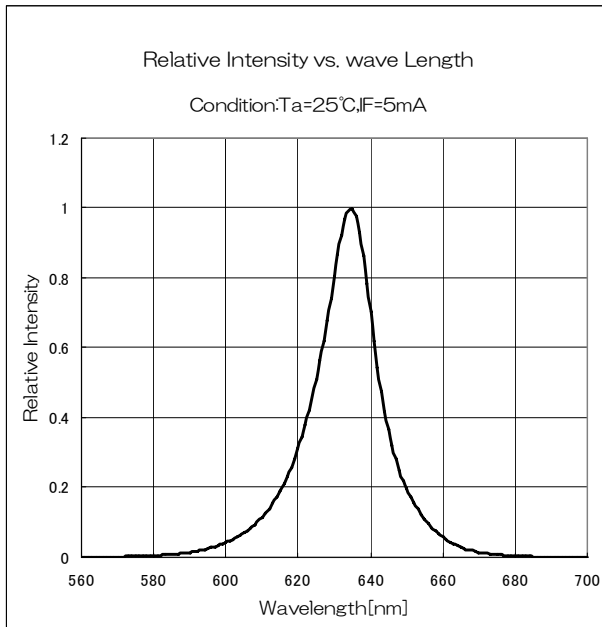

Technical Data (FR)

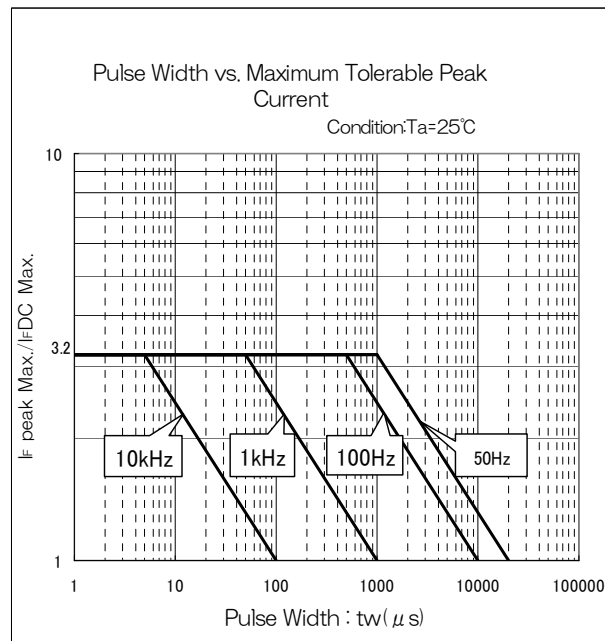
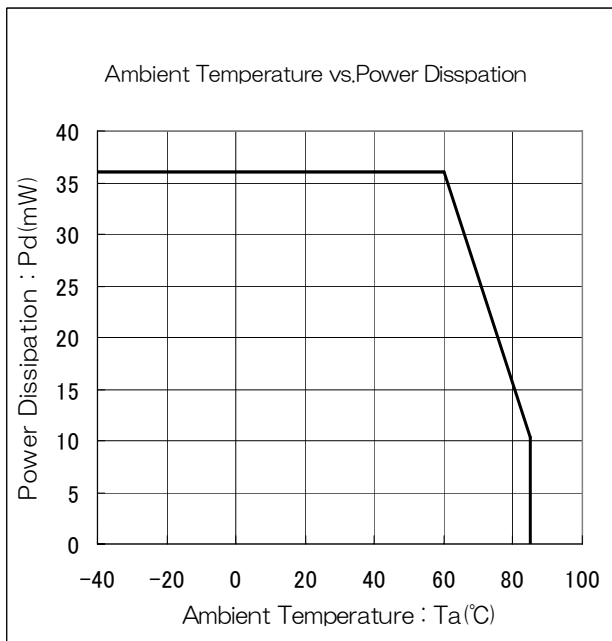
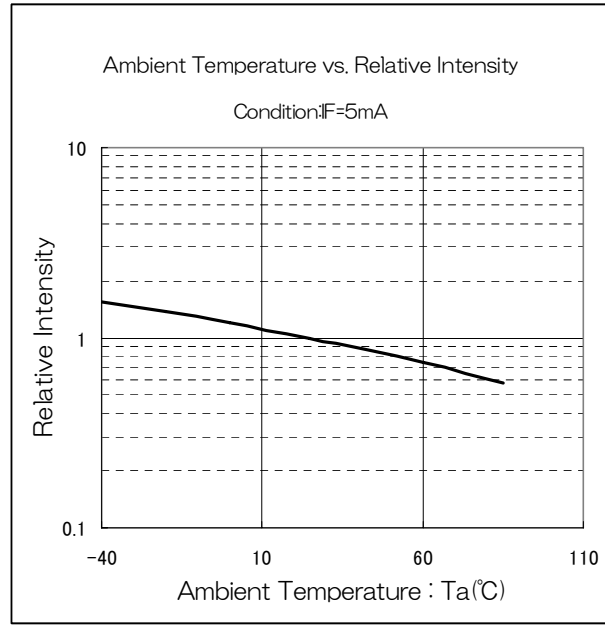
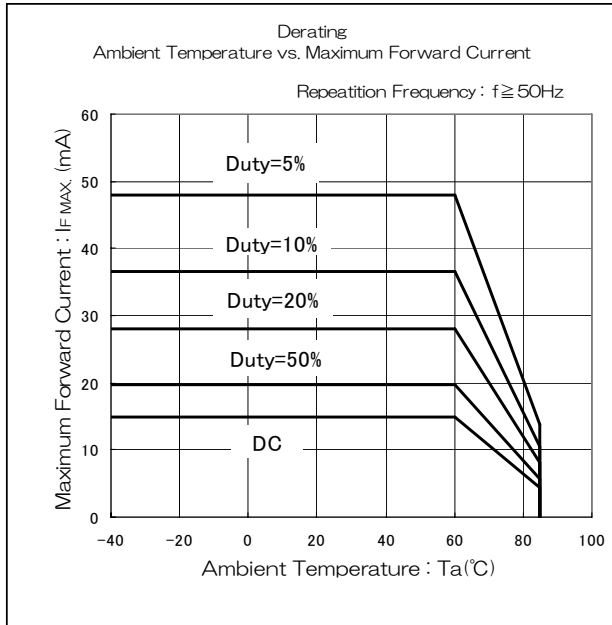

Package Dimensions

(Unit : mm)

MASS : (1.40)mg

SB, SG

YPY, FY, FA, FR

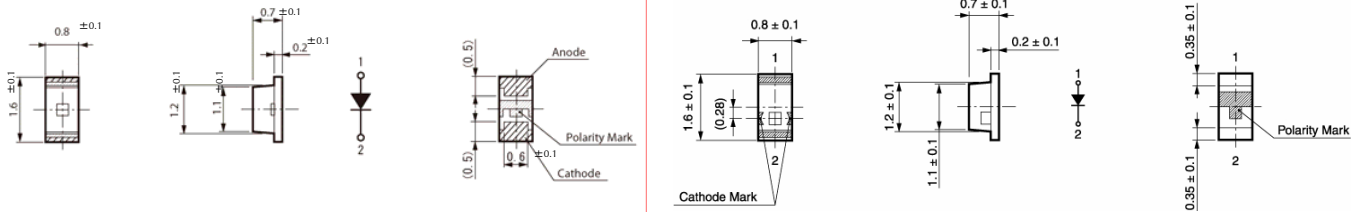

Recommended Soldering Pattern

(Unit : mm)

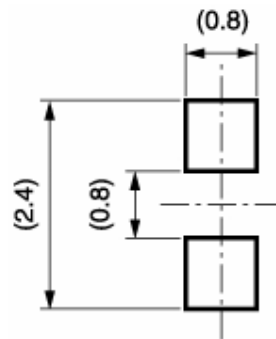

Taping Specification

(Unit : mm)

※Quantity : 4,000pcs/reel(standard)

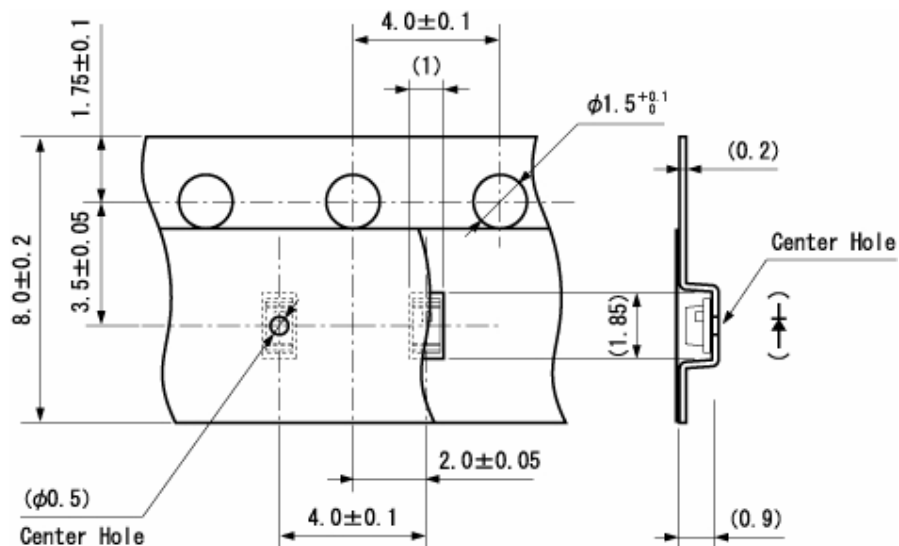

Reflow Soldering Conditions

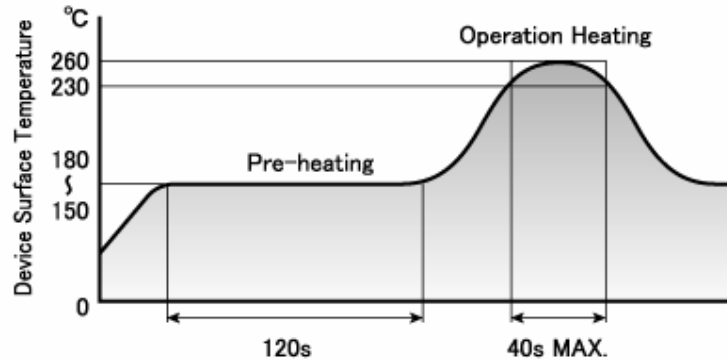

- 1) The above profile temperature gives the maximum temperature of the LED resin surface. Please set the temperature so as to avoid exceeding this range.
- 2) Total times of reflow soldering process shall be no more than 2 times. When the second reflow soldering process is performed, intervals between the first and second reflow should be short as possible (while allowing some time for the component to return to normal temperature after the first reflow) in order to prevent the LED from absorbing moisture.
- 3) Temperature fluctuation to the LED during the pre-heating process shall be minimized.

Manual Soldering Conditions

Iron tip temp.	350 °C (MAX.)
Soldering time and frequency	3 s (MAX.) 1 time (MAX.)

Reliability Testing Result

Reliability Testing Result	Applicable Standard	Testing Conditions	Duration	Failure
Room Temp. Operating Life	EIAJ ED-4701/100(101)	$T_a = 25^\circ\text{C}$, $I_f = \text{Maxium Rated Current}$	1,000 h	0/25
Resistance to Soldering Heat	EIAJ ED-4701/300(301)	Pre-heating : $150\sim 180^\circ\text{C}$ 120s Max. Operation Heating : 230°C 40s Max. Peak Temperature : 260°C	Twice	0/25
Temperature Cycling	EIAJ ED-4701/100(105)	Minimum Rated Storage Temperature(30min) ~Normal Temperature(15min) ~Maximum Rated Storage Temperature(30min) ~Normal Temperature(15min)	5 cycles	0/25
Wet High Temp. Storage Life	EIAJ ED-4701/100(103)	$T_a = 60 \pm 2^\circ\text{C}$, $\text{RH} = 90 \pm 5\%$	1,000 h	0/25
High Temp. Storage Life	EIAJ ED-4701/200(201)	$T_a = \text{Maximum Rated Storage Temperature}$	1,000 h	0/25
Low Temp. Storage Life	EIAJ ED-4701/200(202)	$T_a = \text{Minimum Rated Storage Temperature}$	1,000 h	0/25
Vibration, Variable Frequency	EIAJ ED-4701/400(403)	98.1m/s^2 (10G), 100 ~ 2KHz sweep for 20min., XYZ each direction	2 h	0/10

Failure Criteria

Items	Symbols	Conditions	Failure criteria
Luminous Intensity	I_v	I_f Value of each product Luminous Intensity	Testing Min. Value < Spec. Min. Value x 0.5
Forward Voltage	V_f	I_f Value of each product Forward Voltage	Testing Max. Value \geq Spec. Max. Value x 1.2
Reverse Current	I_R	$V_R = \text{Maximum Rated Reverse Voltage V}$	Testing Max. Value \geq Spec. Max. Value x 2.5
Cosmetic Appearance	-	-	Occurrence of notable decoloration, deformation and cracking

Special Notice to Customers Using the Products and Technical Information Shown in This Data Sheet

- 1) The technical information shown in the data sheets are limited to the typical characteristics and circuit examples of the referenced products. It does not constitute the warranting of industrial property nor the granting of any license.
- 2) For the purpose of product improvement, the specifications, characteristics and technical data described in the data sheets are subject to change without prior notice. Therefore it is recommended that the most updated specifications be used in your design.
- 3) When using the products described in the data sheets, please adhere to the maximum ratings for operating voltage, heat dissipation characteristics, and other precautions for use. We are not responsible for any damage which may occur if these specifications are exceeded.
- 4) The products that have been described to this catalog are manufactured so that they will be used for the electrical instrument of the benchmark (OA equipment, telecommunications equipment, AV machine, home appliance and measuring instrument).
The application of aircrafts, space borne application, transportation equipment, medical equipment and nuclear power control equipment, etc. needs a high reliability and safety, and the breakdown and the wrong operation might influence the life or the human body. Please consult us beforehand if you plan to use our product for the usages of aircrafts, space borne application, transportation equipment, medical equipment and nuclear power control equipment, etc. except OA equipment, telecommunications equipment, AV machine, home appliance and measuring instrument.
- 5) In order to export the products or technologies described in this data sheet which are under the "Foreign Exchange and Foreign Trade Control Law," it is necessary to first obtain an export permit from the Japanese government.
- 6) No part of this data sheet may be reprinted or reproduced without prior written permission from Stanley Electric Co., Ltd.
- 7) The most updated edition of this data sheet can be obtained from the address below:
<http://www.stanley-components.com>