



## BTA08/BTB08 Series 8A TRIACs

### DESCRIPTION:

High current density due to double mesa technology; SIPOS and Glass Passivation.

BTA08/BTB08 series triacs is suitable for general purpose AC switching. They can be used as an ON/OFF Function in applications such as static relays, heating regulation, induction motor starting circuits... or for phase control operation light dimmers, motorspeed controllers.

BTA08/BTB08- $\times\times\times$ SW, - $\times\times\times$ CW, - $\times\times\times$ BW are 3 Quadrants triacs, They are specially recommended for use on inductive loads.

BTA08 are isolated internally, they provides a 2500V RMS isolation voltage from all three terminals to external heatsink.

### MAIN FEATURES

Symbol	Value	Unit
$I_{T(RMS)}$	8	A
$V_{DRM}/V_{RRM}$	600and800	V
$V_{TM}$	$\leq 1.55$	V

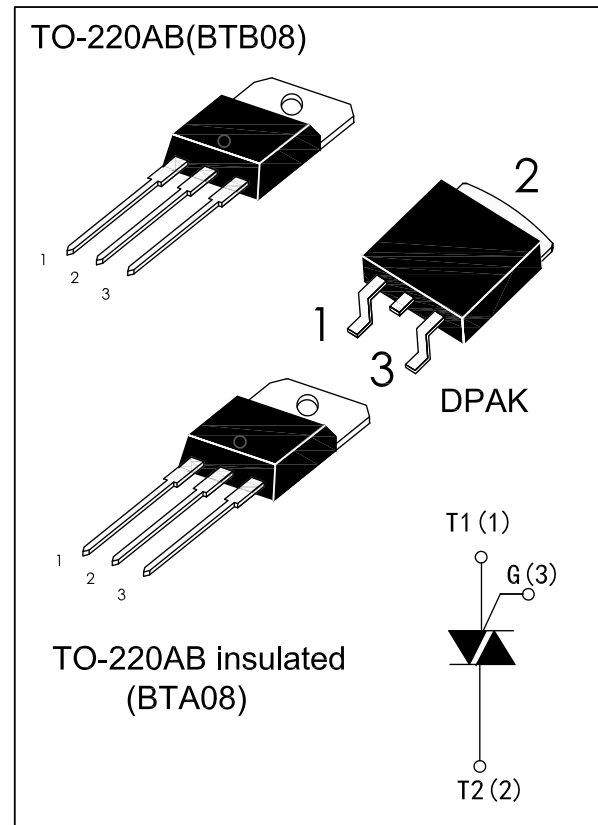

### ABSOLUTE MAXIMUM RATINGS

Parameter	Symbol	Value	Unit
Storage junction temperature range	$T_{stg}$	-40 to +150	$^{\circ}C$
Operating junction temperature range	$T_j$	-40 to +125	$^{\circ}C$
Repetitive Peak Off-state Voltage	$V_{DRM}$	600and800	V
Repetitive Peak Reverse Voltage	$V_{RRM}$	600and800	V
Non repetitive Surge Peak Off-state Voltage	$V_{DSM}$	700and900	V
Non repetitive Peak Reverse Voltage	$V_{RSM}$	700and900	V
RMS on-state current (full sine wave)	DPAK / TO-220AB $T_c=110^{\circ}C$	8	A
	TO-220AB Ins $T_c=100^{\circ}C$		
Non repetitive surge peak on-state current (full cycle, $T_j=25^{\circ}C$ )	$f=50\text{ Hz}$ $t=20\text{ms}$	80	A
	$f=60\text{ Hz}$ $t=16.7\text{ms}$		
$I^2t$ Value for fusing $t_p=10\text{ms}$	$I^2t$	36	$A^2s$
Critical rate of rise of on-state current $I_G=2 \times I_{GT}$ , $t_r \leq 100\text{ ns}$ , $f=120\text{Hz}$ , $T_j=125^{\circ}C$	$di/dt$	50	A/us
Peak gate current $t_p=20\text{us}$ , $T_j=125^{\circ}C$	$I_{GM}$	4	A
Average gate power dissipation $T_j=125^{\circ}C$	$P_{G(AV)}$	1	W

ELECTRICAL CHARACTERISTICS ( $T_j=25^\circ\text{C}$  unless otherwise specified)

## ● 3 Quadrants

Symbol	Test Condition	Quadrant		BTA08/BTB08			Unit
				SW	CW	BW	
IGT	$V_D=12\text{V}$ $R_L=30\Omega$	I - II - III	MAX.	10	35	50	mA
VGT		I - II - III	MAX.	1.3			V
VGD	$V_D=V_{DRM}$ $R_L=3.3\text{K}\Omega$ $T_j=125^\circ\text{C}$	I - II - III	MIN..	0.2			V
IL	$I_G=1.2I_{GT}$	I - III	MAX.	25	50	70	mA
		II		30	60	80	
IH	$I_T=100\text{mA}$		MAX.	15	35	50	mA
dV/dt	$V_D=67\%V_{DRM}$ gate open $T_j=125^\circ\text{C}$		MIN.	40	500	1000	V/ $\mu\text{s}$
(dI/dt)c	(dV/dt) $c=0.1\text{V}/\mu\text{s}$ $T_j=125^\circ\text{C}$		MIN.	5.4	---	---	A/ms
	(dV/dt) $c=10\text{V}/\mu\text{s}$ $T_j=125^\circ\text{C}$			2.8	---	---	
	Without snubber $T_j=125^\circ\text{C}$			---	4.5	7.0	

## ● 4 Quadrants

Symbol	Test Condition	Quadrant		BTA08/BTB08		Unit
				C	B	
IGT	$V_D=12\text{V}$ $R_L=30\Omega$	I - II - III IV	MAX.	25 50	50 100	mA
VGT		ALL	MAX.	1.3		V
VGD	$V_D=V_{DRM}$ $R_L=3.3\text{K}\Omega$ $T_j=125^\circ\text{C}$	ALL	MIN.	0.2		V
IL	$I_G=1.2I_{GT}$	I - III - IV	MAX.	40	50	mA
		II		80	100	
IH	$I_T=100\text{mA}$		MAX.	25	50	mA
dV/dt	$V_D=67\%V_{DRM}$ gate open $T_j=125^\circ\text{C}$		MIN.	200	400	V/ $\mu\text{s}$
(dI/dt)c	(dV/dt) $c=0.1\text{V}/\mu\text{s}$ $T_j=125^\circ\text{C}$		MIN.	---	---	A/ms
	(dV/dt) $c=10\text{V}/\mu\text{s}$ $T_j=125^\circ\text{C}$			---	---	
	Without snubber $T_j=125^\circ\text{C}$			---	---	

## STATIC CHARACTERISTICS

Symbol	Test Conditions		Value (MAX)	Unit
$V_{TM}$	$I_{TM}=11A$ , $t_p=380\mu S$	$T_j=25^\circ C$	1.55	V
$I_{DRM}$	$V_D=V_{DRM}$	$T_j=25^\circ C$	5	$\mu A$
$I_{RRM}$	$V_R=V_{RRM}$	$T_j=125^\circ C$	1	mA

## THERMAL RESISTANCES

Symbol	Parameter		Value	Unit
$R_{th(j-c)}$	Junction to case (AC)	DPAK/TO-220AB	1.6	$^\circ C/W$
		TO-220AB Insulated	2.5	

## ORDERING INFORMATION

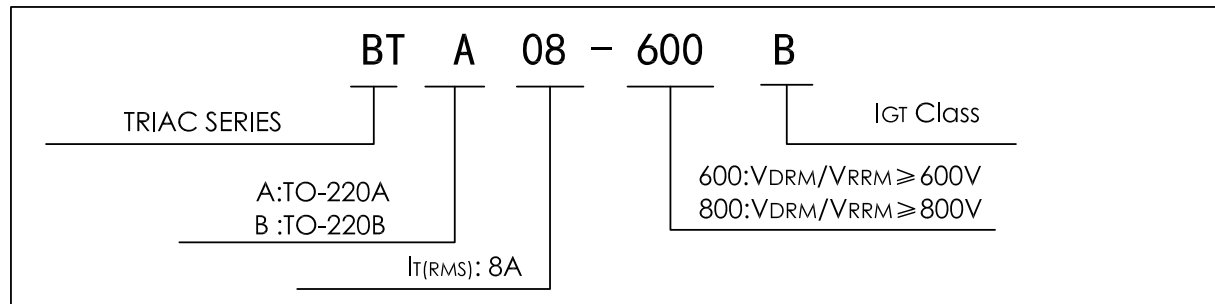

PACKAGE MECHANICAL DATA

TO-220AB

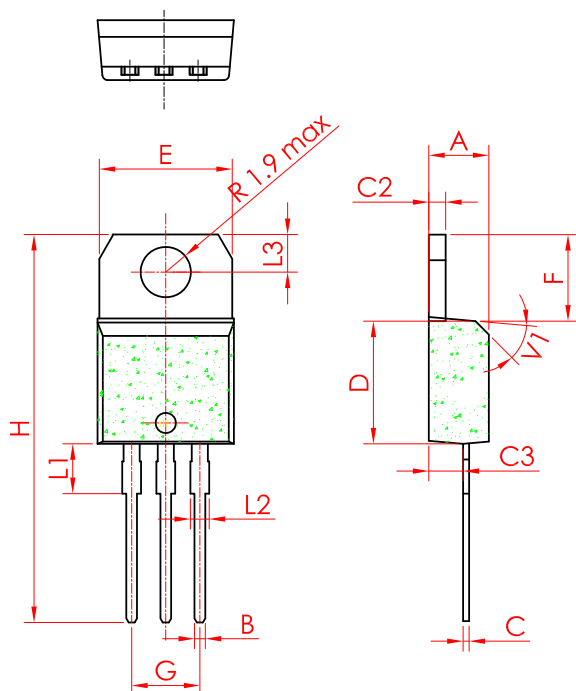

Ref.	Dimensions					
	Millimeters			Inches		
	Min.	Typ.	Max.	Min.	Typ.	Max.
A	4.4		4.6	0.173		1.181
B	0.61		0.88	0.024		0.034
C	0.49		0.70	0.019		0.027
C2	1.23		1.32	0.048		0.051
C3	2.4		2.72	0.094		0.107
D	8.6		9.7	0.338		0.382
E	10		10.4	0.393		0.409
F	6.2		6.6	0.244		0.259
G	4.8		5.4	0.189		0.213
H	28.0		29.8	11.0		11.7
L1		3.75			0.147	
L2	1.14		1.7	0.044		0.066
L3	2.65		2.95	0.104		0.116
V1		40°			40°	

DPAK

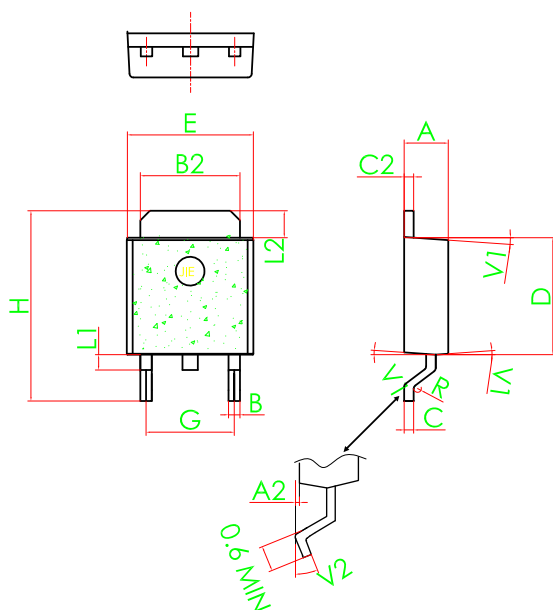

Ref.	Dimensions					
	Millimeters			Inches		
	Min.	Typ.	Max.	Min.	Typ.	Max.
A	2.2		2.4	0.086		0.095
A2	0.03		0.23	0.001		0.009
B	0.55		0.65	0.021		0.026
B2	5.2		5.4	0.204		0.212
C	0.45		0.62	0.017		0.024
C2	0.48		0.62	0.019		0.024
D	6		6.2	0.236		0.244
E	6.4		6.6	0.251		0.259
G	4.40		4.60	0.173		0.181
H	9.35		10.1	0.368		0.397
L1		0.8			0.031	
L2	1.37		1.5	0.054		0.059
V1		4°			4°	
V2	0°		8°	0°		8°

**FIG.1:** Maximum power dissipation versus RMS on-state current(full cycle)

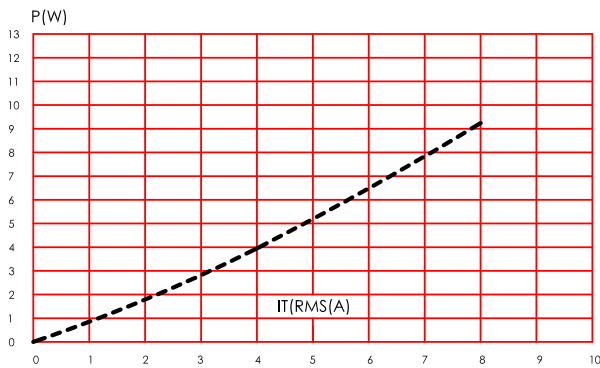

**FIG.2:** RMS on-state current versus case temperature(full cycle)

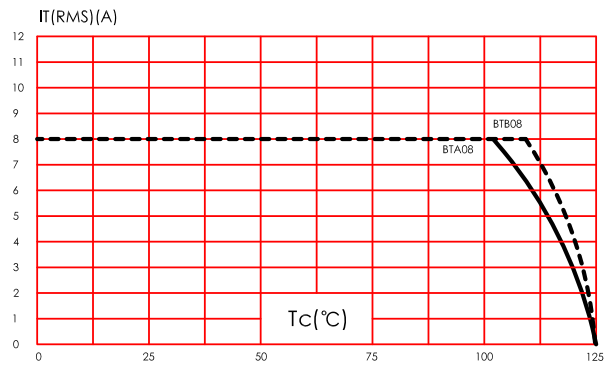

**FIG.3:** On-state characteristics (maximum values)

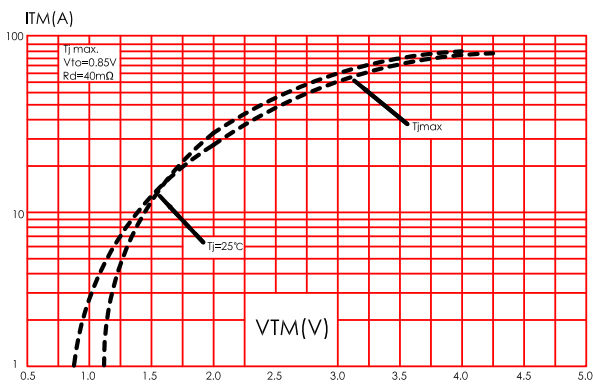

**FIG.4:** Surge peak on-state current versus number of cycles.

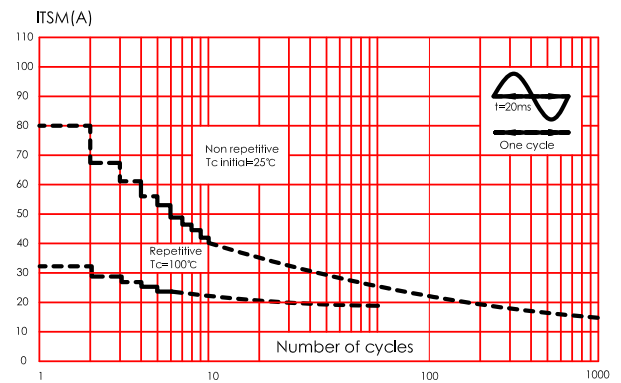

**FIG.5:** Non-repetitive surge peak on-state current for a sinusoidal pulse with width  $t_p < 10\text{ms}$ , and corresponding value of  $I^2t$

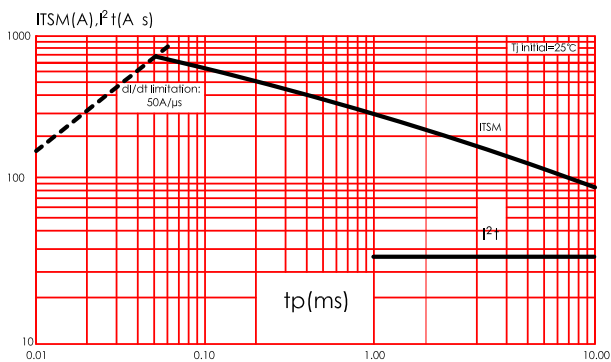

**FIG.6:** Relative variation of gate trigger current, holding current and latching current versus junction temperature(typical values).

