

# DIELECTRIC RESONATOR OSCILLATOR

**MDR2100-05500**

**5500 - 6500 MHz**

## Features

- Rugged Construction for Extreme Environmental Conditions
- High Frequency Stability
- Free Running, Mechanically Tuned

## Specifications<sup>1</sup>

CHARACTERISTIC	TYPICAL Ta = +25 °C	MIN/MAX Ta = -20°C to +65 °C
Frequency	5500 - 6500 MHz	5500 - 6500 MHz
Mechanical Tuning Bandwidth (MHz)	—	±20 Min.
Frequency Stability <sup>2</sup> (ppm)/ °C	4	5 Max.
Pulling, 12 dB RL (ppm)	—	±100 Max.
Pushing (ppm/Volt)	—	20 Max.
Harmonics (dBc)	-20	-15 Max.
Spurious (dBc)	-75	-70 Max.
Output Power (dBm) <sup>3</sup>	+11	+10 Min.
Power Vdc <sup>4</sup> mA	+15 120	+15 125 Max.

NOTES: Care should always be taken to effectively ground the case of each unit.

1. Specifications labeled "min." or "max." are guaranteed in a 50 Ohm system over the specified temperature range.
2. Averaged over the full temperature range.
3. Higher output power is available.
4. Alternate input voltage is available.
5. Package must be verified by Spectrum Microwave.

## Absolute Maximum Ratings

Ambient Operating Temperature ..... -55°C to +100 °C  
 Storage Temperature ..... -62°C to +125 °C  
 Case Temperature ..... +125 °C  
 DC Voltage ..... +24 Volts

## Typical Performance Data

Phase Noise	Typical 5500 MHz	Typical 6500 MHz
Offset		
10 kHz	-101	-99
100 kHz	-126	-124
1 MHz	-146	-144

Phase Noise (dBc/Hz)  
5500 MHz

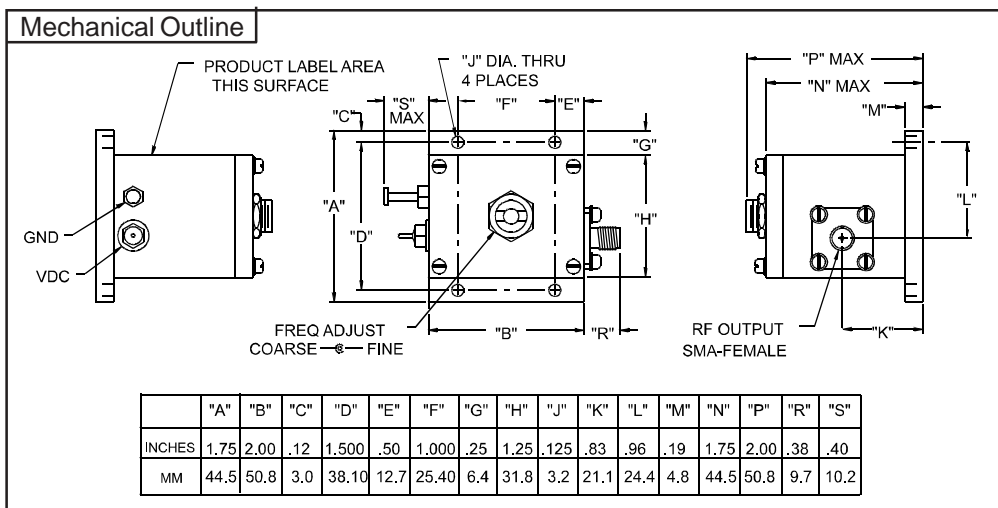
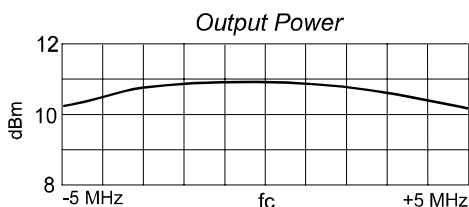
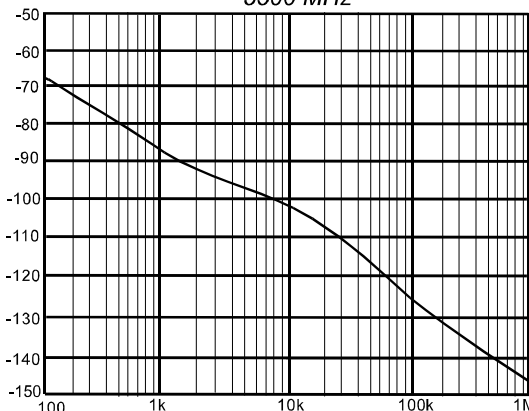

Spectrum Microwave · 2144 Franklin Drive N.E. · Palm Bay, Florida 32905 · PH (888) 553-7531 · Fax (888) 553-7532

Rev. 10/23/08

www.SpectrumMicrowave.com Spectrum Microwave · 2707 Black Lake Place · Philadelphia, Pennsylvania 19154 · PH (215) 464-4000 · Fax (215) 464-4001