

SMCG AND SMCJ5.0 THRU 170CA

SURFACE MOUNT TRANSZORB™ TRANSIENT VOLTAGE SUPPRESSOR

Stand-off Voltage - 5.0 - 170 Volts Peak Pulse Power - 1500 Watts

DO-214AB
MODIFIED J-BEND

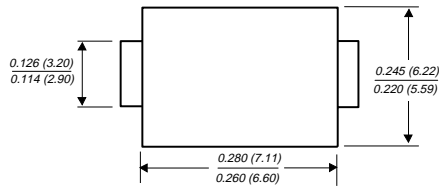

DO-215AB
GULL WING

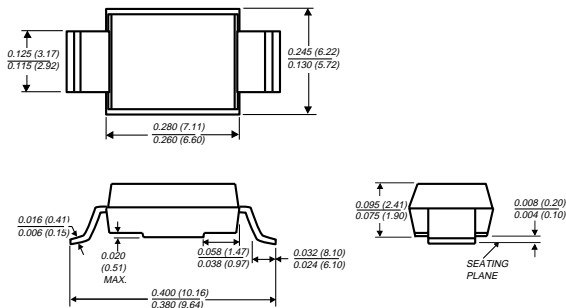

Dimensions in inches and (millimeters)

FEATURES

- ◆ Plastic package has Underwriters Laboratory Flammability Classification 94V-0
- ◆ For surface mounted applications in order to optimize board space
- ◆ Low profile package
- ◆ Built-in strain relief
- ◆ Glass passivated junction
- ◆ Low inductance
- ◆ 1500W peak pulse power capability with a 10/1000μs waveform, repetition rate (duty cycle): 0.01%
- ◆ Excellent clamping capability
- ◆ Fast response time: typically less than 1.0ps from 0 Volts to $V_{(BR)}$ for uni-directional and 5.0ns for bi-directional types
- ◆ For devices with $V_{(BR)} \geq 10V$, I_D are typically less than 1.0μA
- ◆ High temperature soldering guaranteed: 250°C/10 seconds at terminals



MECHANICAL DATA

Case: JEDEC DO214AB / DO215AB molded plastic over passivated junction

Terminals: Solder plated, solderable per MIL-STD-750, Method 2026

Polarity: For unidirectional types the color band denotes the cathode, which is positive with respect to the anode under normal TVS operation

Mounting Position: Any

Weight: 0.007 ounces, 0.21 gram

DEVICES FOR BI-DIRECTIONAL APPLICATIONS

For bi-directional use add suffix C or CA for types SMC-5.0 thru SMC-170 (e.g. SMC5.0C, SMCJ170CA).

Electrical characteristics apply in both directions.

MAXIMUM RATINGS AND ELECTRICAL CHARACTERISTICS

Ratings at 25°C ambient temperature unless otherwise specified.

	SYMBOLS	VALUE	UNITS
Peak pulse power dissipation with a 10/1000μs waveform (NOTES 1, 2, FIG. 1)	PPPM	Minimum 1500	Watts
Peak pulse current with a 10/1000μs waveform (NOTE 1, FIG. 3)	I _{PPM}	SEE TABLE 1	Amps
Peak forward surge current 8.3ms single half sine-wave superimposed on rated load (JEDEC Method) (NOTES 2, 3) - uni-directional only	I _{FSM}	200.0	Amps
Maximum instantaneous forward voltage at 100A (NOTE 3) uni-directional only	V _F	3.5	Volts
Operating junction and storage temperature range	T _J , T _{STG}	-55 to +150	°C

NOTES:

- (1) Non-repetitive current pulse, per Fig.3 and derated above $T_A=25^\circ\text{C}$ per Fig. 2
- (2) Mounted on 0.31 x 0.31" (8.0 x 8.0mm) copper pads to each terminal
- (3) Measured on 8.3ms single half sine-wave. For uni-directional devices only.

ELECTRICAL CHARACTERISTICS at (T_A=25°C unless otherwise noted) TABLE 1

Device Type Gull Wing Lead	Device Type Modified "J" Bend Lead	Device Marking Code		Breakdown Voltage V _(BR) (Volts) (NOTE 1) (MIN / MAX)	Test Current at I _T (mA)	Stand-off Voltage V _{WM} (Volts)	Maximum Reverse Leakage at V _{WM} (NOTE 3) I _D (μA)	Maximum Peak Pulse Surge Current I _{PPM} (NOTE 2) (Amps)	Maximum Clamping Voltage at I _{PPM} V _C (Volts)
		UNI	BI						
SMCG5.0	SMCJ5.0	GDD	GDD	6.40 / 7.82	10.0	5.0	1000	156.3	9.6
SMCG5.0A	SMCJ5.0	GDE	GDE	6.40 / 7.07	10.0	5.0	1000	163.0	9.2
SMCG6.0	SMCJ6.0	GDF	GDF	6.67 / 8.15	10.0	6.0	1000	131.6	11.4
SMCG6.0A	SMCJ6.0A	GDG	GDG	6.67 / 7.37	10.0	6.0	1000	145.6	10.3
SMCG6.5	SMCJ6.5	GDH	BDH	7.22 / 8.82	10.0	6.5	500	122.0	12.3
SMCG6.0A	SMCJ6.5A	GDK	BDK	7.22 / 7.98	10.0	6.5	500	133.9	11.2
SMCG7.0	SMCJ7.0	GDL	GDL	7.78 / 9.51	10.0	7.0	200	112.8	13.3
SMCG7.0A	SMCJ7.0A	GDM	GDM	7.78 / 8.60	10.0	7.0	200	125.0	12.0
SMCG7.5	SMCJ7.5	GDN	BDN	8.33 / 10.2	1.0	7.5	100	104.9	14.3
SMCG7.5A	SMCJ7.5A	GDP	BDP	8.33 / 9.21	1.0	7.5	100	116.3	12.9
SMCG8.0	SMCJ8.0	GDQ	BDG	8.89 / 10.9	1.0	8.0	50	100.0	15.0
SMCG8.0A	SMCJ8.0A	GDR	BDR	8.89 / 9.83	1.0	8.0	50	110.3	13.6
SMCG8.5	SMCJ8.5	GDS	BDS	9.44 / 11.5	1.0	8.5	20	94.3	15.9
SMCG8.5A	SMCJ8.5A	GDT	BDT	9.44 / 10.4	1.0	8.5	20	104.2	14.4
SMCG9.0	SMCJ9.0	GDU	BDU	10.0 / 12.2	1.0	9.0	10	88.8	16.9
SMCG9.0A	SMCJ9.0A	GDV	BDV	10.0 / 11.1	1.0	9.0	10	97.4	15.4
SMCG10	SMCJ10	GDW	BDW	11.1 / 13.6	1.0	10.0	5.0	79.8	18.8
SMCG10A	SMCJ10A	GDX	BDX	11.1 / 12.3	1.0	10.0	5.0	88.2	17.0
SMCG11	SMCJ11	GDY	GDY	12.2 / 14.9	1.0	11.0	5.0	74.6	20.1
SMCG11A	SMCJ11A	GDZ	GDZ	12.2 / 13.5	1.0	11.0	5.0	82.4	18.2
SMCG12	SMCJ12	GED	BED	13.3 / 16.3	1.0	12.0	5.0	68.2	22.0
SMCG12A	SMCJ12A	GEE	BEE	13.3 / 14.7	1.0	12.0	5.0	75.4	19.9
SMCG13	SMCJ13	GEF	GEF	14.4 / 17.6	1.0	13.0	5.0	63.0	23.8
SMCG13A	SMCJ13A	GEG	GEG	14.4 / 15.9	1.0	13.0	5.0	69.8	21.5
SMCG14	SMCJ14	GEH	BEH	15.6 / 19.1	1.0	14.0	5.0	58.1	25.8
SMCG14A	SMCJ14A	GEK	BEK	15.6 / 17.2	1.0	14.0	5.0	64.7	23.2
SMCG15	SMCJ15	GEL	BEL	16.7 / 20.4	1.0	15.0	5.0	55.8	26.9
SMCG15A	SMCJ15A	GEM	BEM	16.7 / 18.5	1.0	15.0	5.0	61.5	24.4
SMCG16	SMCJ16	GEN	GEN	17.8 / 21.8	1.0	16.0	5.0	52.1	28.8
SMCG16A	SMCJ16A	GEP	GEP	17.8 / 19.7	1.0	16.0	5.0	57.7	26.0
SMCG17	SMCJ17	GEQ	GEQ	18.9 / 23.1	1.0	17.0	5.0	49.2	30.5
SMCG17A	SMCJ17A	GER	GER	18.9 / 20.9	1.0	17.0	5.0	54.3	27.6
SMCG18	SMCJ18	GES	BES	20.0 / 24.4	1.0	18.0	5.0	46.6	32.2
SMCG18A	SMCJ18A	GET	BET	20.0 / 22.1	1.0	18.0	5.0	51.4	29.2
SMCG20	SMCJ20	GEU	BEU	22.2 / 27.1	1.0	20.0	5.0	41.9	35.8
SMCG20A	SMCJ20A	GEV	BEV	22.2 / 24.5	1.0	20.0	5.0	46.3	32.4
SMCG22	SMCJ22	GEW	BEW	24.4 / 29.8	1.0	22.0	5.0	38.1	39.4
SMCG22A	SMCJ22A	GEX	BEX	24.4 / 26.9	1.0	22.0	5.0	42.3	35.5
SMCG24	SMCJ24	GEY	BEY	26.7 / 32.6	1.0	24.0	5.0	34.9	43.0
SMCG24A	SMCJ24A	GEZ	BEZ	26.7 / 29.5	1.0	24.0	5.0	38.6	38.9
SMCG26	SMCJ26	GFD	BFD	28.9 / 35.3	1.0	26.0	5.0	32.2	46.6
SMCG26A	SMCJ26A	GFE	BFE	28.9 / 31.9	1.0	26.0	5.0	35.6	42.1
SMCG28	SMCJ28	GFF	BFF	31.1 / 38.0	1.0	28.0	5.0	30.0	50.0
SMCG28A	SMCJ28A	GFG	BFG	31.1 / 34.4	1.0	28.0	5.0	33.0	45.4
SMCG30	SMCJ30	GFH	BFH	33.3 / 40.7	1.0	30.0	5.0	28.0	53.5
SMCG30A	SMCJ30A	GFK	BFK	33.3 / 36.8	1.0	30.0	5.0	31.0	48.4
SMCG33	SMCJ33	GFL	BFL	36.7 / 44.9	1.0	33.0	5.0	25.4	59.0
SMCG33A	SMCJ33A	GFM	BFM	36.7 / 40.6	1.0	33.0	5.0	28.1	53.3
SMCG36	SMCJ36	GFN	BFN	40.0 / 48.9	1.0	36.0	5.0	23.3	64.3
SMCG36A	SMCJ36A	GFP	BFN	40.0 / 44.2	1.0	36.0	5.0	25.8	58.1
SMCG40	SMCJ40	GFQ	BFQ	44.4 / 54.3	1.0	40.0	5.0	21.0	71.4
SMCG40A	SMCJ40A	GFR	BFR	44.4 / 49.1	1.0	40.0	5.0	23.3	64.5
SMCG43	SMCJ43	GFS	BFS	47.8 / 58.4	1.0	43.0	5.0	19.6	76.7
SMCG43A	SMCJ43A	GFT	BFT	47.8 / 52.8	1.0	43.0	5.0	21.6	69.4
SMCG45	SMCJ45	GFU	BFU	50.0 / 61.1	1.0	45.0	5.0	18.7	80.3
SMCG45A	SMCJ45A	GFV	BFV	50.0 / 55.3	1.0	45.0	5.0	20.6	72.7
SMCG48	SMCJ48	GFW	BFW	53.3 / 65.1	1.0	48.0	5.0	17.5	85.5
SMCG48A	SMCJ48A	GFX	BFX	53.3 / 58.9	1.0	48.0	5.0	19.4	77.4
SMCG51	SMCJ51	GFY	BFY	56.7 / 69.3	1.0	51.0	5.0	16.5	91.1
SMCG51A	SMCJ51A	GFZ	BFZ	56.7 / 62.7	1.0	51.0	5.0	18.2	82.4

ELECTRICAL CHARACTERISTICS at (T_A=25°C unless otherwise noted) TABLE 1 (Cont'd)

Device Type Gull Wing Lead	Device Type Modified "J" Bend Lead	Device Marking Code		Breakdown Voltage V _(BR) (Volts) (NOTE 1) (MIN / MAX)	Test Current at I _T (mA)	Stand-off Voltage V _{WM} (Volts)	Maximum Reverse Leakage at V _{WM} (NOTE 3) I _D (μA)	Maximum Peak Pulse Surge Current I _{PPM} (NOTE 2) (Amps)	Maximum Clamping Voltage at I _{PPM} V _C (Volts)
		UNI	BI						
SMCG54	SMCJ54	GGD	GGD	60.0 / 73.3	1.0	54.0	5.0	15.6	96.3
SMCG54A	SMCJ54A	GGE	GGE	60.0 / 66.3	1.0	54.0	5.0	17.2	87.1
SMCG58	SMCJ58	GGF	GGF	64.4 / 78.7	1.0	58	5.0	14.6	103
SMCG58A	SMCJ58A	GGG	GGG	6.4.4 / 71.2	1.0	58	5.0	16.0	93
SMCG60	SMCJ60	GGH	GGH	66.7 / 81.5	1.0	60	5.0	14.0	107
SMCG60A	SMCJ60A	GGK	GGK	66.7 / 73.7	1.0	60	5.0	15.5	96
SMCG64	SMCJ64	GGL	GGL	71.1 / 86.9	1.0	64	5.0	13.2	114
SMCG64A	SMCJ64A	GGM	GGM	71.1 / 78.6	1.0	64	5.0	14.6	103
SMCG70	SMCJ70	GGN	GGN	77.8 / 95.1	1.0	70	5.0	12.0	125
SMCG70A	SMCJ70A	GGP	GGP	77.8 / 86.0	1.0	70	5.0	13.3	113
SMCG75	SMCJ75	GGQ	GGQ	83.3 / 102	1.0	75	5.0	11.2	134
SMCG75A	SMCJ75A	GGR	GGR	83.3 / 92.1	1.0	75	5.0	12.4	121
SMCG78	SMCJ78	GGs	GGs	86.7 / 106	1.0	78	5.0	10.8	139
SMCG78A	SMCJ78A	GGT	GGT	86.7 / 95.8	1.0	78	5.0	11.9	126
SMCG85	SMCJ85	GGU	GGU	94.4 / 115	1.0	85	5.0	9.9	151
SMCG85A	SMCJ85A	GGV	GGV	94.4 / 104	1.0	85	5.0	10.9	137
SMCG90	SMCJ90	GGW	GGW	100 / 122	1.0	90	5.0	9.4	160
SMCG90A	SMCJ90A	GGX	GGX	100 / 111	1.0	90	5.0	10.3	146
SMCG100	SMCJ100	GGY	GGY	111 / 136	1.0	100	5.0	8.4	179
SMCG100A	SMCJ100A	GGZ	GGZ	111 / 123	1.0	100	5.0	9.3	162
SMCG110	SMCJ110	GHD	GHD	122 / 149	1.0	110	5.0	7.7	196
SMCG110A	SMCJ110A	GHE	GHE	122 / 135	1.0	110	5.0	8.5	177
SMCG120	SMCJ120	GHF	GHF	133 / 163	1.0	120	5.0	7.0	214
SMCG120A	SMCJ120A	GHG	GHG	133 / 147	1.0	120	5.0	7.8	193
SMCG130	SMCJ130	GHH	GHH	144 / 176	1.0	130	5.0	6.5	231
SMCG130A	SMCJ130A	GHK	GHK	144 / 159	1.0	130	5.0	7.2	209
SMCG150	SMCJ150	GHL	GHL	16.7 / 204	1.0	150	5.0	5.6	268
SMCG150A	SMCJ150A	GHM	GHM	167 / 185	1.0	150	5.0	6.2	243
SMCG160	SMCJ160	GHN	GHN	178 / 218	1.0	160	5.0	5.2	287
SMCG160A	SMCJ160A	GHP	GHP	178 / 197	1.0	160	5.0	5.8	259
SMCG170	SMCJ170	GHQ	GHQ	189 / 231	1.0	170	5.0	4.9	304
SMCG170A	SMCJ170A	GHR	GHR	189 / 209	1.0	170	5.0	5.5	275

NOTES:

- (1) V_(BR) measured after I_T applied for 300μs square wave pulse or equivalent
- (2) Surge current waveform per Fig. 3 and derate per Fig. 2
- (3) For bi-directional types having V_{WM} of 10 Volts and less, the I_D limit is doubled
- (4) For the bi-directional SMCG/SMCJ5.0CA, the maximum V_(BR) is 7.25 Volts
- (5) All terms and symbols are consistent with ANSI/IEEE C62.35

APPLICATION NOTES

These surface mountable packages are designed specifically for transient voltage suppression. The wide leads assure a large surface contact for good heat dissipation, and a low resistance path for surge current flow to ground. These high speed transient voltage suppressors can be used to effectively protect sensitive components such as integrated circuits and MOS devices.

A 1500W (SMC) device is normally selected when the threat of transients is from lightning-induced transients conducted via external leads or I/O lines. It is also used to protect against switching transients induced by large coils or industrial motors. System impedance at component level in a system is usually high enough to limit the current to within the peak pulse current (I_{PP}) rating of this series.

RECOMMENDED PAD SIZES

The pad dimensions should be 0.010" (0.25mm) longer than the contact size, in the lead axis. This allows a solder fillet to form, see figure below. Contact factory for soldering methods.

GULL-WING

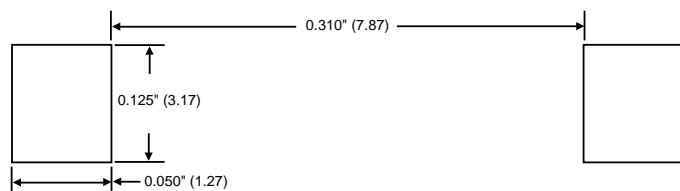

MODIFIED J-BEND

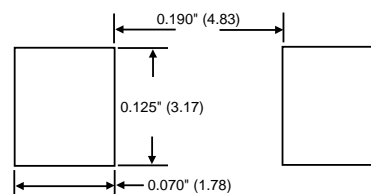

MAXIMUM RATINGS AND CHARACTERISTIC CURVES SMCG AND SMCJ5.0 THRU 170CA

FIG. 1 - PEAK PULSE POWER RATING CURVE

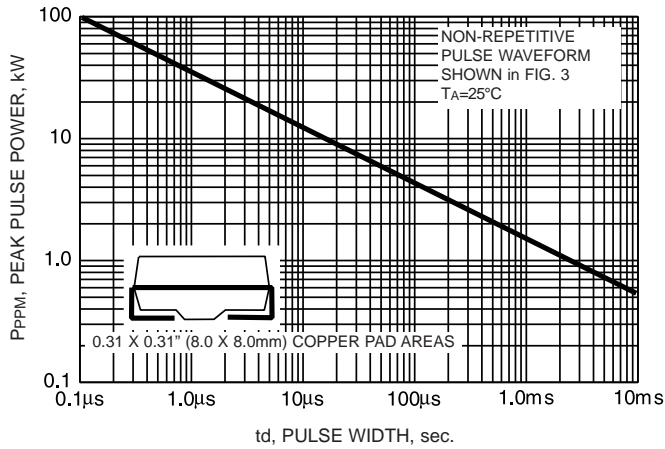

FIG. 2 - PULSE DERATING CURVE

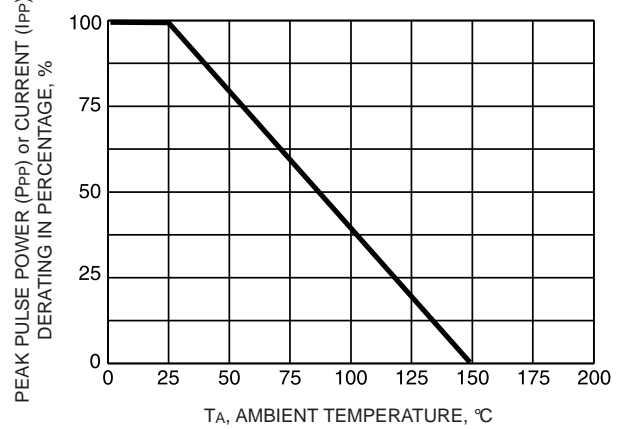

FIG. 3 - PULSE WAVEFORM

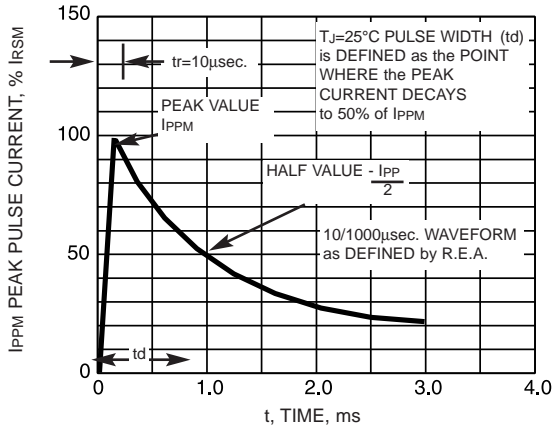

FIG. 4 - TYPICAL JUNCTION CAPACITANCE UNI-DIRECTIONAL

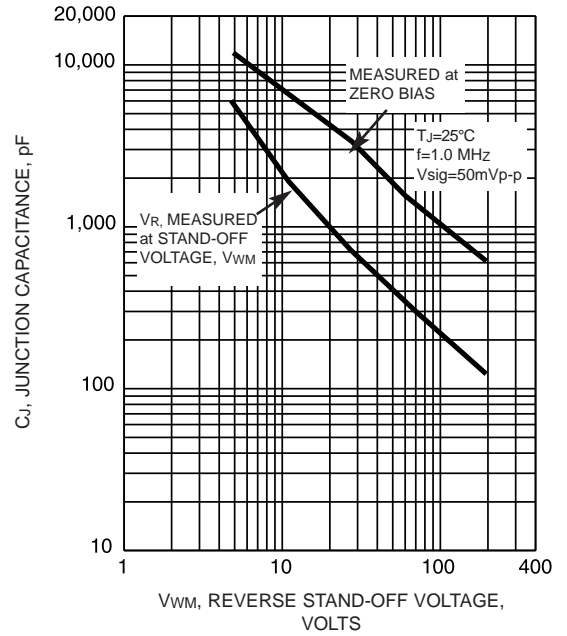

FIG. 5 - TYPICAL JUNCTION CAPACITANCE BI-DIRECTIONAL

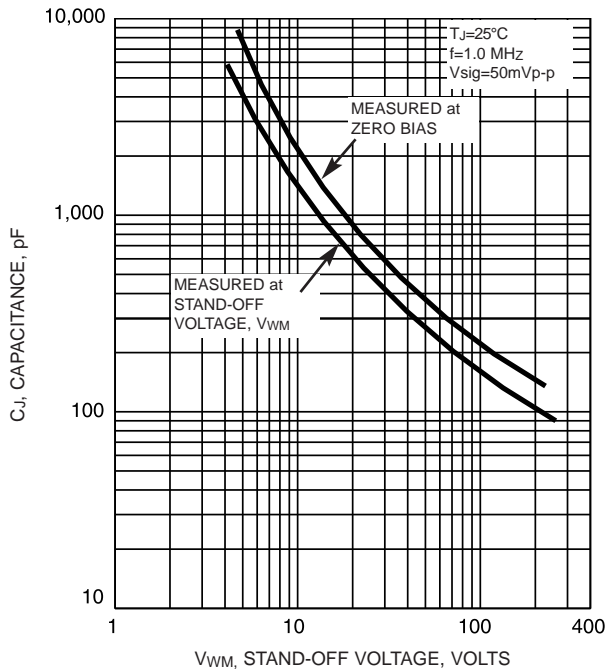

FIG. 6 - MAXIMUM NON-REPETITIVE PEAK FORWARD SURGE CURRENT

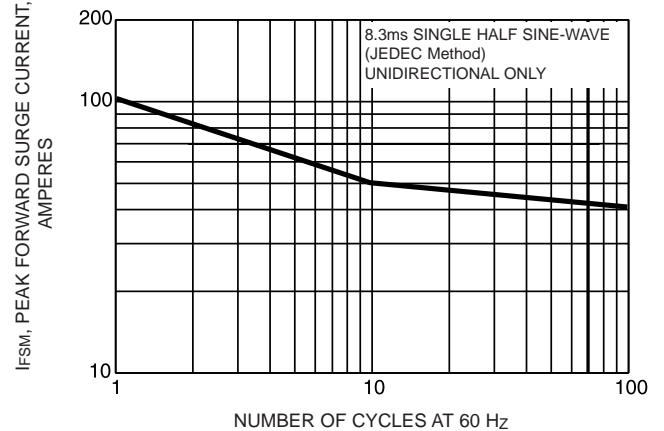

FIG. 7 - MAXIMUM CONTINUOUS POWER DISSIPATION

