

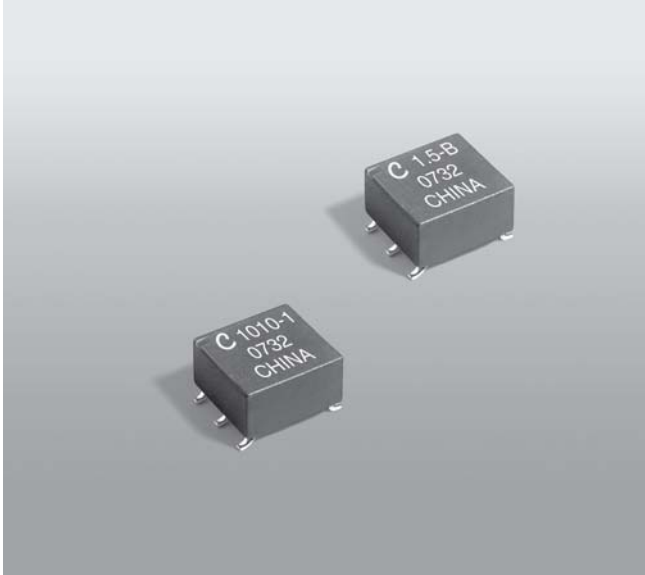

# Surface Mount Wideband RF Transformers



- Cost effective surface mount wideband transformers
- 300 V interwinding isolation, 1/4 Watt RF input power
- 250 mA max current rating.

**Core material** Ferrite

**Terminations** RoHS compliant tin-silver-copper over tin over nickel over phos bronze. Other terminations available at additional cost.

**Weight** 250 – 270 mg

**Ambient temperature** –40°C to +85°C

**Storage temperature** Component: –40°C to +85°C.  
Packaging: –40°C to +80°C

**Resistance to soldering heat** Max three 40 second reflows at +260°C, parts cooled to room temperature between cycles

**Moisture Sensitivity Level (MSL)** 1 (unlimited floor life at <30°C / 85% relative humidity)

**Failures in Time (FIT) / Mean Time Between Failures (MTBF)**  
60 per billion hours / 16,666,667 hours, calculated per Telcordia SR-332

**Packaging** 250/7" reel; 1000/13" reel Plastic tape: 16 mm wide, 0.35 mm thick, 12 mm pocket spacing, 5.0 mm pocket depth

**PCB washing** Only pure water or alcohol recommended

## Typical Frequency Response

Part number	3 dB (MHz)	2 dB (MHz)	1 dB (MHz)
PWB-1-AL_	0.08 – 450	0.13 – 325	0.30 – 190
PWB-1.5-AL_	0.03 – 300	0.035 – 250	0.06 – 150
PWB-2-AL_	0.05 – 200	0.06 – 160	0.10 – 100
PWB-4-AL_	0.15 – 500	0.24 – 300	0.60 – 140
PWB-16-AL_	0.05 – 80	0.06 – 75	0.11 – 30
PWB1010L_	0.0035 – 125	0.0045 – 100	0.007 – 80
PWB1010-1L_	0.03 – 250	0.04 – 225	0.06 – 200
PWB1015L_	0.07 – 225	0.10 – 200	0.20 – 125
PWB1040L_	0.15 – 400	0.25 – 350	0.80 – 250
PWB-1-BL_	0.13 – 425	0.18 – 325	0.32 – 190
PWB-1.5-BL_	0.50 – 250	0.80 – 175	1.50 – 120
PWB-2-BL_	0.20 – 400	0.225 – 275	0.50 – 150
PWB-4-BL_	0.14 – 700	0.20 – 400	0.40 – 150
PWB-16-BL_	0.075 – 90	0.11 – 75	0.20 – 65
PWB2010L_	0.0035 – 125	0.0045 – 100	0.007 – 80
PWB2010-1L_	0.03 – 250	0.04 – 225	0.06 – 200
PWB2040L_	0.15 – 400	0.25 – 350	0.80 – 250
PWB-1-CL_	0.10 – 300	0.13 – 200	0.20 – 150
PWB-1.5-CL_	0.15 – 200	0.225 – 150	0.35 – 100
PWB-2-CL_	0.13 – 285	0.20 – 175	0.325 – 125
PWB-4-CL_	0.14 – 500	0.20 – 230	0.40 – 110
PWB3010L_	0.0035 – 125	0.0045 – 100	0.007 – 80
PWB3010-1L_	0.03 – 250	0.04 – 225	0.06 – 200
PWB3015L_	0.07 – 225	0.10 – 200	0.20 – 125
PWB3040L_	0.15 – 400	0.25 – 350	0.80 – 250

## Dimensions

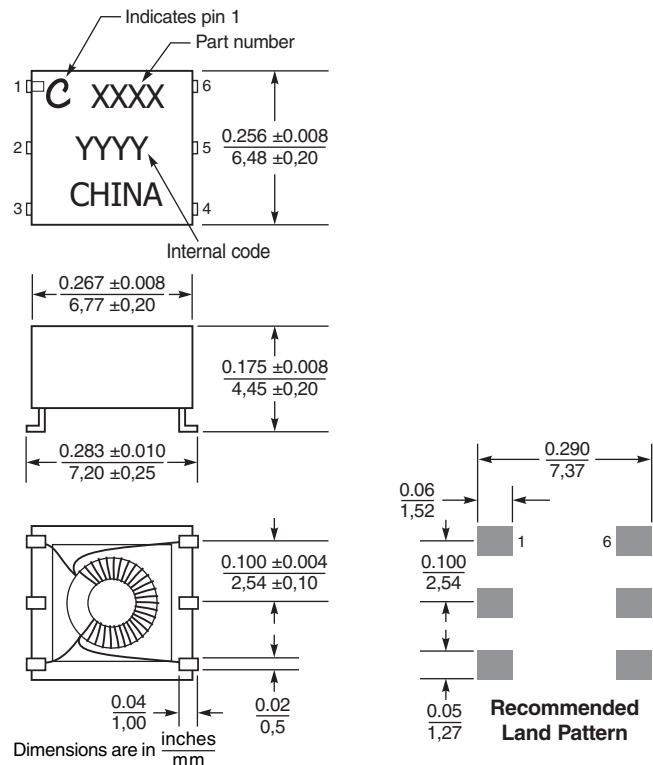

# Coilcraft®

Specifications subject to change without notice.  
Please check our website for latest information.

Document 591-1 Revised 02/04/10

1102 Silver Lake Road Cary, Illinois 60013 Phone 847/639-6400 Fax 847/639-1469

E-mail [info@coilcraft.com](mailto:info@coilcraft.com) Web <http://www.coilcraft.com>

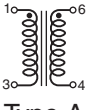
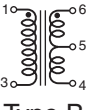
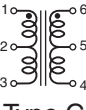

# Surface Mount Wideband RF Transformers

Type	Part number <sup>1</sup>	Impedance ratio <sup>2</sup> pri:sec	Bandwidth (MHz)	Idc (mA)	Insertion loss max (dB)	L min <sup>3</sup> ( $\mu$ H)	Pins 1-3 DCR max (Ohms)	L min <sup>3</sup> ( $\mu$ H)	Pins 6-4 DCR max (Ohms)
 Type A	PWB-1-AL_	1:1	0.08 - 450	250	0.60	40	0.070	40	0.070
	PWB-1.5-AL_	1:1.5	0.03 - 300	250	0.35	110	0.080	160	0.110
	PWB-2-AL_	1:2	0.05 - 200	250	0.25	75	0.088	150	0.120
	PWB-4-AL_	1:4	0.15 - 500	250	0.50	25	0.075	98	0.135
	PWB-16-AL_	1:16	0.05 - 80	250	0.35	75	0.260	1250	0.910
	PWB1010L_	1:1	0.0035 - 125	250	0.20	780	0.320	780	0.320
	PWB1010-1L_	1:1	0.03 - 250	250	0.20	95	0.200	95	0.200
 Type B	PWB-1-BL_	1:1	0.13 - 425	250	0.40	22	0.070	22	0.070
	PWB-1.5-BL_	1:1.5	0.50 - 250	250	0.40	140	0.100	200	0.120
	PWB-2-BL_	1:2	0.20 - 400	250	0.35	75	0.088	150	0.130
	PWB-4-BL_	1:4	0.14 - 700	250	0.50	25	0.075	98	0.135
	PWB-16-BL_	1:16	0.075 - 90	250	0.30	75	0.260	1250	0.910
	PWB2010L_	1:1	0.0035 - 125	250	0.20	780	0.320	780	0.320
	PWB2010-1L_	1:1	0.03 - 250	250	0.20	95	0.200	95	0.200
 Type C	PWB-1-CL_	1:1	0.10 - 300	250	0.60	22	0.070	22	0.070
	PWB-1.5-CL_	1:1.5	0.15 - 200	250	0.30	140	0.110	200	0.120
	PWB-2-CL_	1:2	0.13 - 285	250	0.30	75	0.105	150	0.130
	PWB-4-CL_	1:4	0.14 - 500	250	0.50	25	0.075	98	0.135
	PWB3010L_	1:1	0.0035 - 125	250	0.20	780	0.320	780	0.320
	PWB3010-1L_	1:1	0.03 - 250	250	0.20	95	0.200	95	0.200
	PWB3015L_	1:1.5	0.07 - 225	250	0.40	51	0.130	80	0.145
PWB3040L_	1:4	0.15 - 400	250	0.40	25	0.115	95	0.160	

1. When ordering, please specify **termination** and **packaging** codes:

PWB-3010-1 L D

**Termination:** L = RoHS compliant tin-silver-copper over tin over nickel over phos bronze.  
Special order: S = non-RoHS tin-lead (63/37).

**Packaging:** C = 7" machine ready reel. EIA-481 embossed plastic tape, 250 parts per full reel.

B = Less than full reel. In tape, but not machine ready. To have a leader and trailer added (\$25 charge), use code letter C instead.

D = 13" machine ready reel. EIA-481 embossed plastic tape. Factory order only, not stocked (1000 parts per full reel).

2. Impedance ratio is for the full primary winding to the full secondary winding.

3. Inductance tested at 130 kHz, 0.1 Vrms, 0 Adc.

4. Electrical specifications at 25°C.

Refer to Doc 362 "Soldering Surface Mount Components" before soldering.

# Coilcraft®

Specifications subject to change without notice.  
Please check our website for latest information.

Document 591-2 Revised 02/04/10

1102 Silver Lake Road Cary, Illinois 60013 Phone 847/639-6400 Fax 847/639-1469

E-mail [info@coilcraft.com](mailto:info@coilcraft.com) Web <http://www.coilcraft.com>



# Type A Transformers

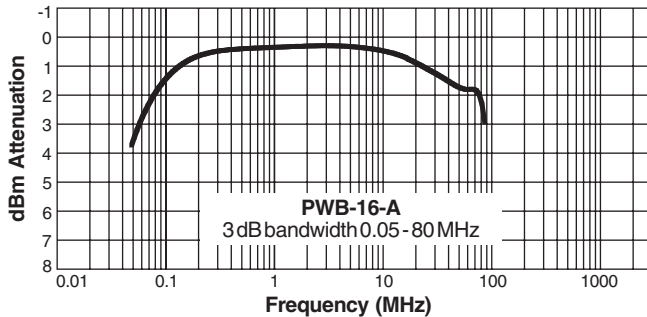
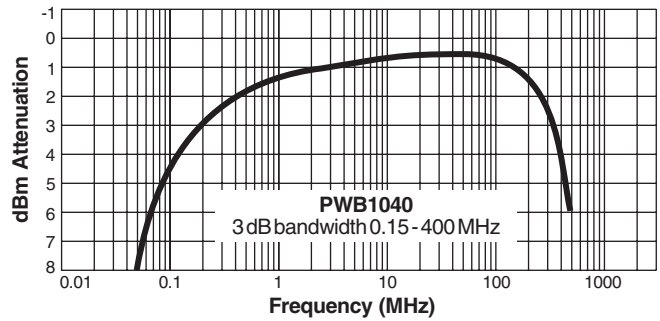
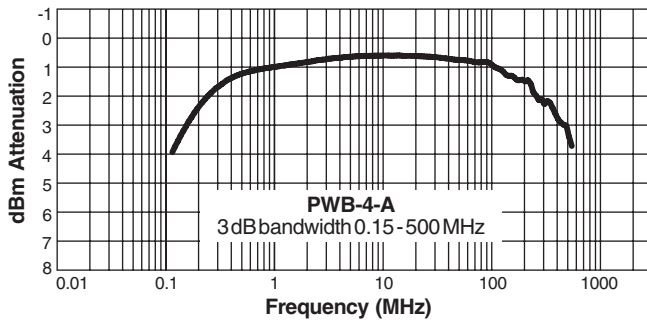
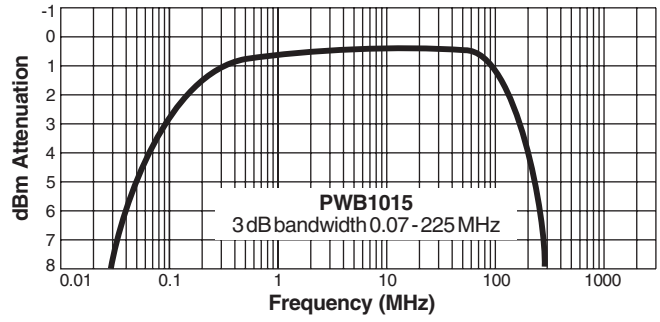
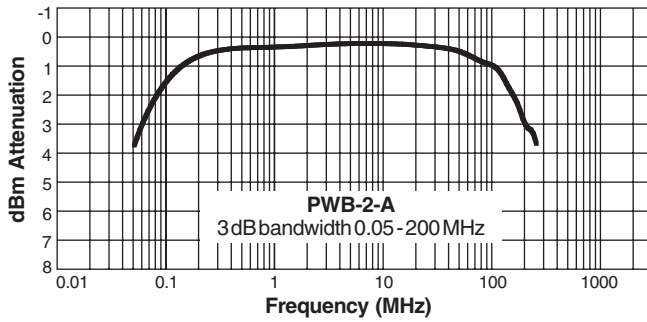
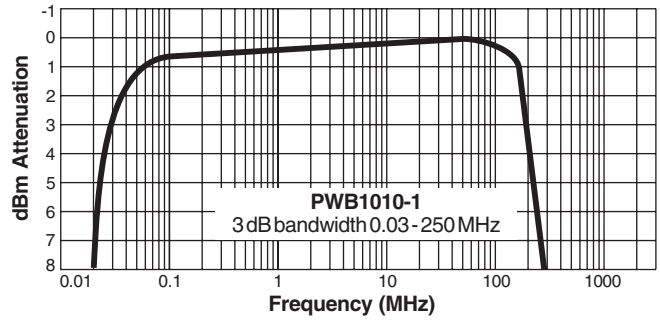
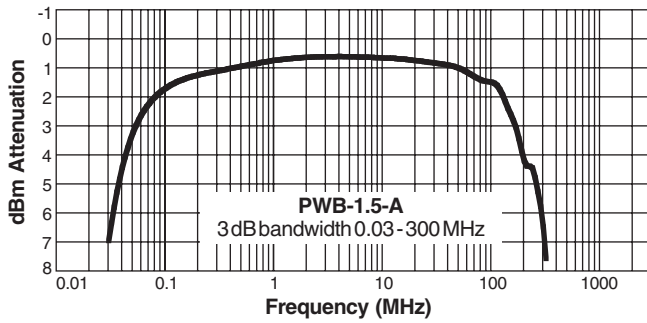
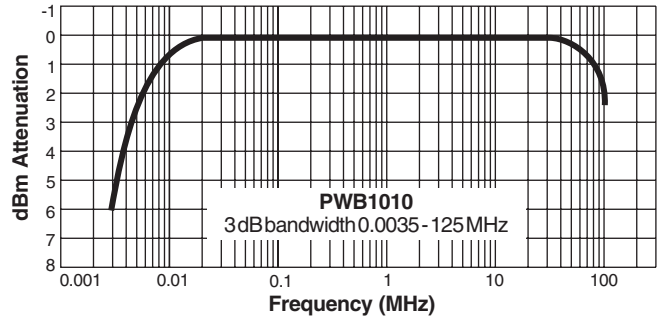
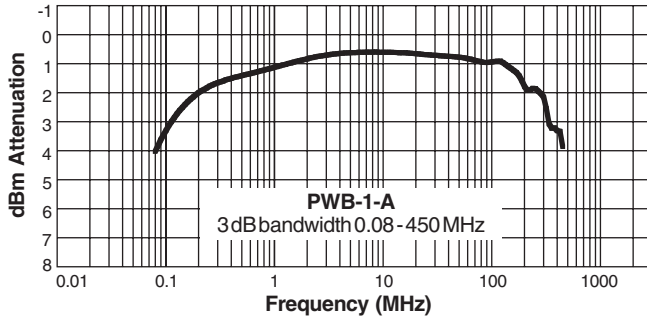

Attenuation measured on a network analyzer (re: 50 Ohms)



Specifications subject to change without notice.  
Please check our website for latest information.

Document 591-3 Revised 02/04/10

1102 Silver Lake Road Cary, Illinois 60013 Phone 847/639-6400 Fax 847/639-1469

E-mail [info@coilcraft.com](mailto:info@coilcraft.com) Web <http://www.coilcraft.com>



# Type B Transformers

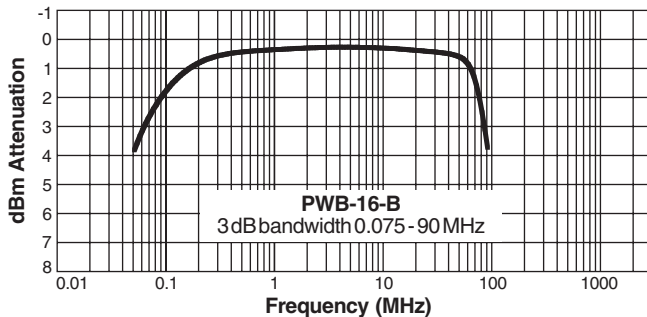
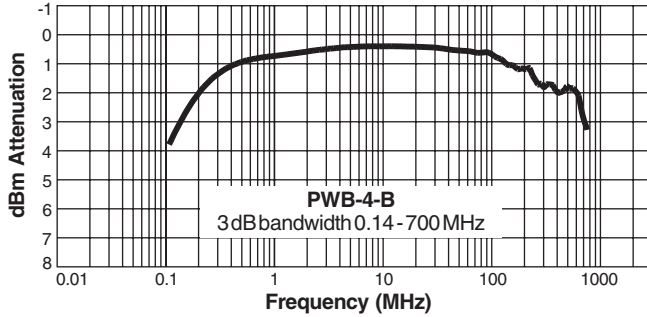
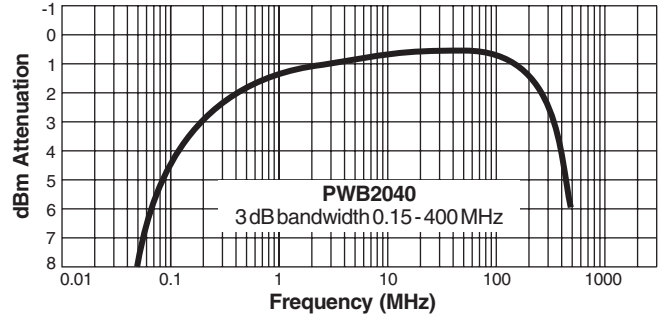
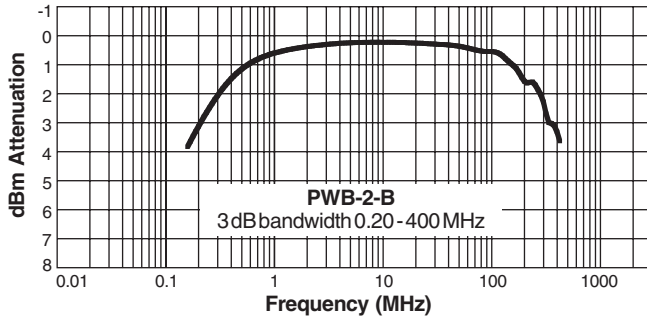
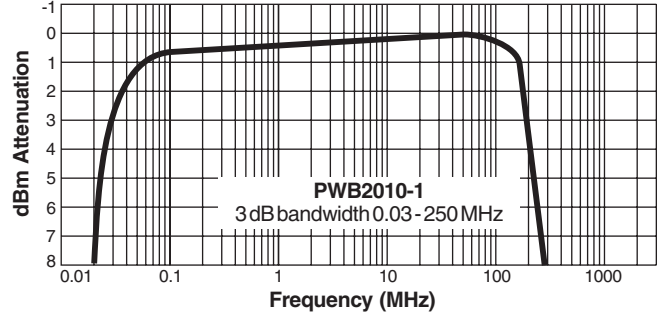
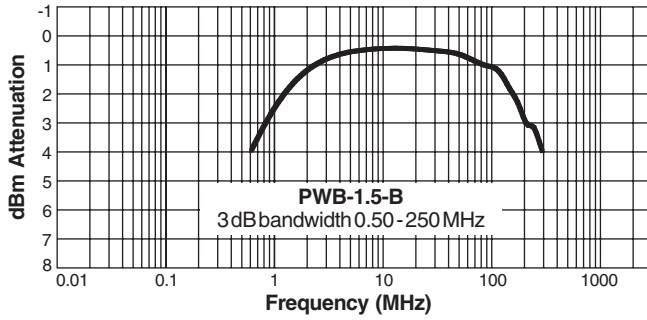
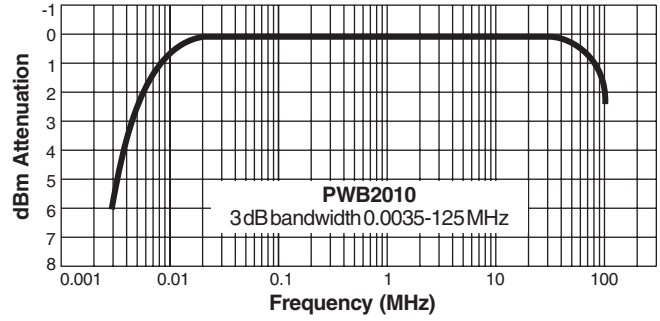
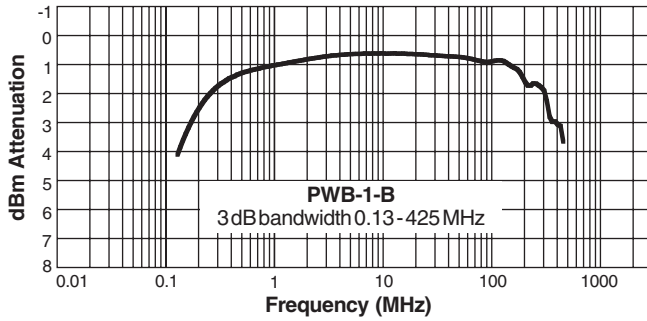

Attenuation measured on a network analyzer (re: 50 Ohms)



Specifications subject to change without notice.  
Please check our website for latest information.

Document 591-4 Revised 02/04/10

1102 Silver Lake Road Cary, Illinois 60013 Phone 847/639-6400 Fax 847/639-1469

E-mail [info@coilcraft.com](mailto:info@coilcraft.com) Web <http://www.coilcraft.com>



# Type C Transformers

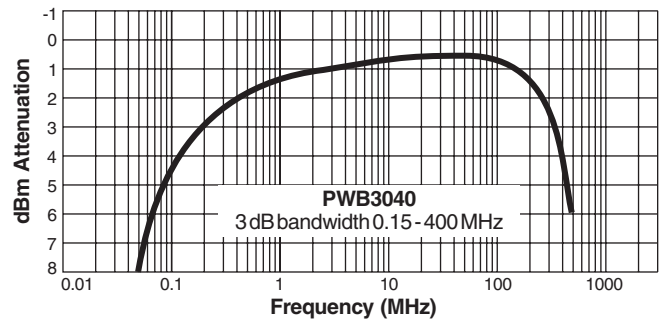
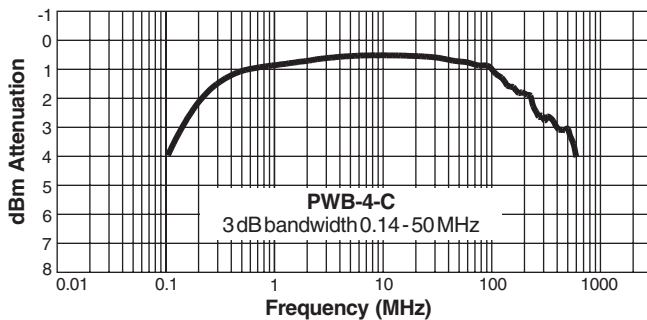
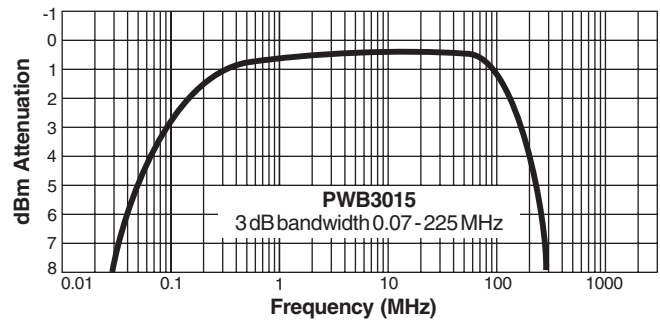
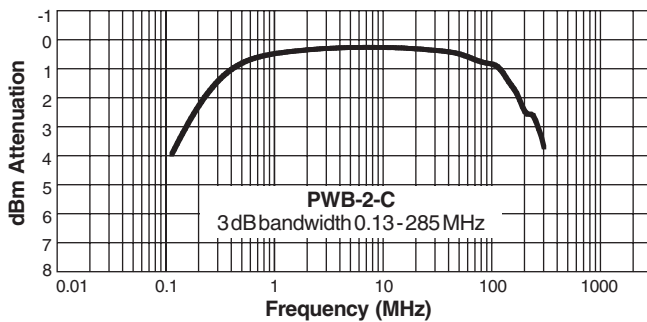
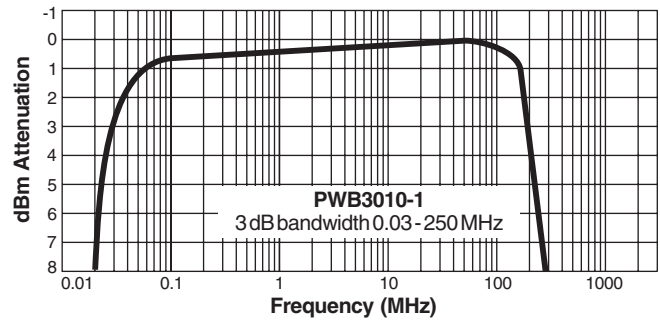
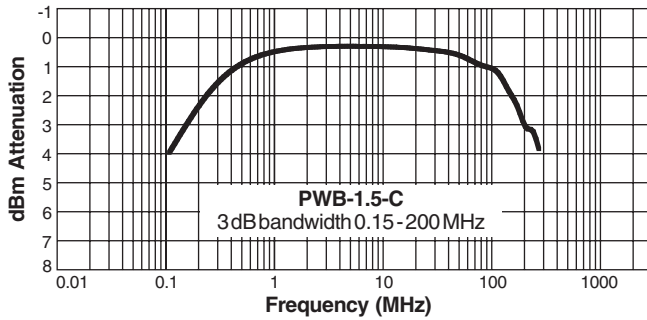
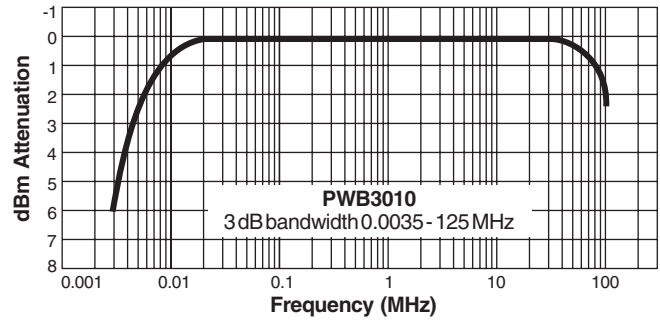
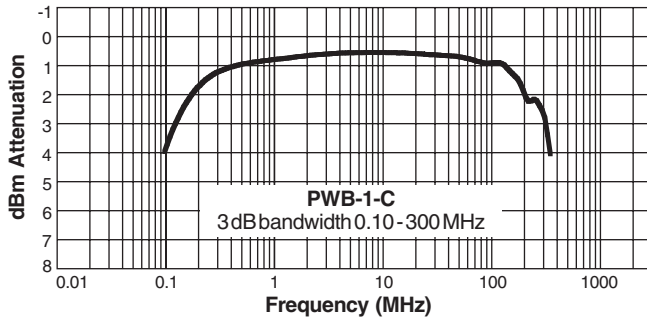

Attenuation measured on a network analyzer (re: 50 Ohms)



Specifications subject to change without notice.  
Please check our website for latest information.

Document 591-5 Revised 02/04/10

1102 Silver Lake Road Cary, Illinois 60013 Phone 847/639-6400 Fax 847/639-1469

E-mail [info@coilcraft.com](mailto:info@coilcraft.com) Web <http://www.coilcraft.com>