



	TS190L	Units
Load Voltage	400	V
Load Current	150	mA
Max R _{ON}	22	Ω

Features

- Small 8 Pin DIP Package
- Low Drive Power Requirements (TTL/CMOS Compatible)
- No Moving Parts
- High Reliability
- Arc-Free With No Snubbing Circuits
- 3750V_{RMS} Input/Output Isolation
- FCC Compatible
- VDE Compatible
- No EMI/RFI Generation
- Machine Insertable, Wave Solderable
- Current Limiting Surface Mount and Tape & Reel Versions Available

Applications

- Telecommunications
 - Telecom Switching
 - Tip/Ring Circuits
 - Modem Switching (Laptop, Notebook, Pocket Size)
 - Hookswitch
 - Dial Pulsing
 - Ground Start
 - Ringer Injection
- Instrumentation
 - Multiplexers
 - Data Acquisition
 - Electronic Switching
 - I/O Subsystems
 - Meters (Watt-Hour, Water, Gas)
- Medical Equipment-Patient/Equipment Isolation
- Security
- Aerospace
- Industrial Controls

Description

TS190L is a 400V, 150mA, 22Ω 1-Form-A relay with an optocoupler in a single package. It features enhanced peak load current handling capability and improved peak load current capability for specialized telecom applications. Current limiting version is available ("L" suffix, see specification for variations in performance).

Approvals

- UL Recognized: File Number E76270
- CSA Certified: File Number LR 43639-10
- BSI Certified to:
 - BS EN 60950:1992 (BS7002:1992)
Certificate #: 7344
 - BS EN 41003:1993
Certificate #: 7344

Ordering Information

Part #	Description
TS190L	8 Pin DIP (50/Tube)
TS190LP	8 Pin Flatpack (50/Tube)
TS190LPTR	8 Pin Flatpack (1000/Reel)
TS190LS	8 Pin Surface Mount (50/Tube)
TS190LSTR	8 Pin Surface Mount (1000/Reel)

Pin Configuration

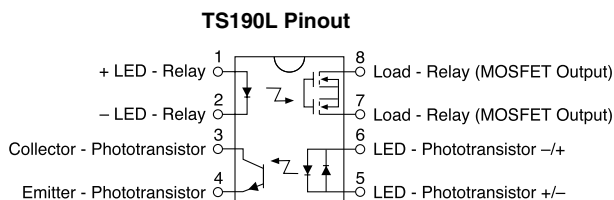

Absolute Maximum Ratings (@ 25° C)

Parameter	Min	Typ	Max	Units
Input Power Dissipation	-	-	150 ¹	mW
Input Control Current	-	-	50	mA
Peak (10ms)	-	-	1	A
Reverse Input Voltage	-	-	5	V
Total Power Dissipation	-	-	800 ²	mW
Isolation Voltage				
Input to Output	3750	-	-	V _{RMS}
Operational Temperature	-40	-	+85	°C
Storage Temperature	-40	-	+125	°C
Soldering Temperature				
DIP Package	-	-	+260	°C
Flatpack/Surface Mount Package	-	-	+220	°C
(10 Seconds Max.)				

¹ Derate Linearly 1.33 mw/°C
² Derate Linearly 6.67 mw/°C

Absolute Maximum Ratings are stress ratings. Stresses in excess of these ratings can cause permanent damage to the device. Functional operation of the device at these or any other conditions beyond those indicated in the operational sections of this data sheet is not implied. Exposure of the device to the absolute maximum ratings for an extended period may degrade the device and effect its reliability.

Electrical Characteristics

Parameter	Conditions	Symbol	Min	Typ	Max	Units
Relay Portion (Pins 7, 8)						
Output Characteristics @ 25°C						
Load Voltage (Peak)	-	V _L	-	-	400	V
Load Current (Continuous)	-	I _L	-	-	150	mA
Peak Load Current	10ms	I _{LPK}	-	-	-	mA
On-Resistance	I _L =150mA	R _{ON}	-	18	25	Ω
Off-State Leakage Current	V _L =400V	I _{LEAK}	-	-	1	μA
Switching Speeds						
Turn-On	I _F =5mA, V _L =10V	T _{ON}	-	-	1	ms
Turn-Off	I _F =5mA, V _L =10V	T _{OFF}	-	-	0.25	ms
Output Capacitance	50V; f=1MHz	C _{OUT}	-	25	-	pF
Load Current Limit		I _{CL}	190	235	280	mA
Relay Portion (Pins 1, 2)						
Input Characteristics @ 25°C						
Input Control Current	I _L =150mA	I _F	5	-	50	mA
Input Dropout Current	-	I _F	0.4	0.7	-	mA
Input Voltage Drop	I _F =5mA	V _F	0.9	1.2	1.4	V
Reverse Input Voltage	-	V _R	-	-	5	V
Reverse Input Current	V _R =5V	I _R	-	-	10	μA

Electrical Characteristics (Continued)

Parameter	Conditions	Symbol	Min	Typ	Max	Units
Detector Portion (Pins 3,4)						
Output Characteristics @ 25°C						
Phototransistor Blocking Voltage	$I_C=10\mu A$	BV_{CEO}	20	50	-	V
Phototransistor Output Current	$V_{CE}=5V, I_F=0mA$	I_{CEO}	-	50	500	nA
Saturation Voltage	$I_C=2mA, I_F=16mA$	V_{SAT}	-	0.3	0.5	V
Current Transfer Ratio	$I_F=6mA, V_{CE}=0.5V$	CTR	33	100	-	%
Detector Portion (Pins 5,6)						
Input Characteristics @ 25°C						
Input Control Current	$I_C=2mA, V_{CE}=0.5V$	I_F	6	2	100	mA
Input Voltage Drop	$I_F=5mA$	V_F	0.9	1.2	1.4	V
Input Current (Detector must be off)	$I_C=1\mu A, V_{CE}=5V$	I_F	5	25	-	μA
Input to Output Capacitance (Relay Only)	-	$C_{I/O}$	-	3	-	pF
Capacitance Input to Output	-	-	-	3	-	pF
Input to Output Isolation	-	$V_{I/O}$	3750	-	-	V_{RMS}

PERFORMANCE DATA*

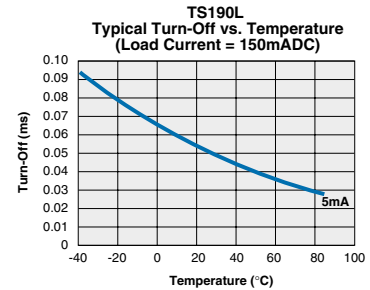
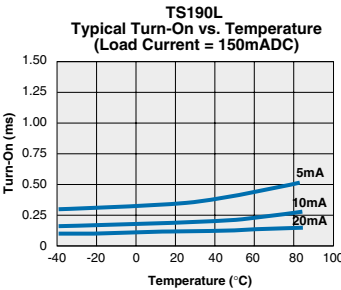
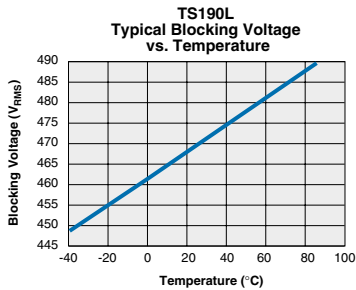
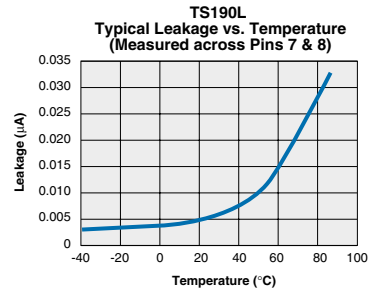
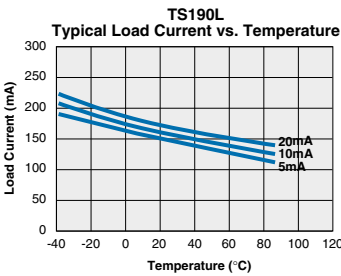
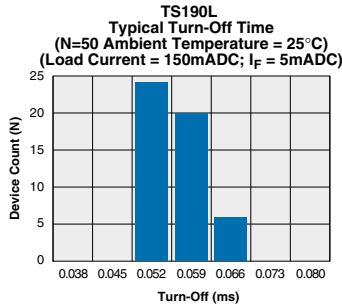
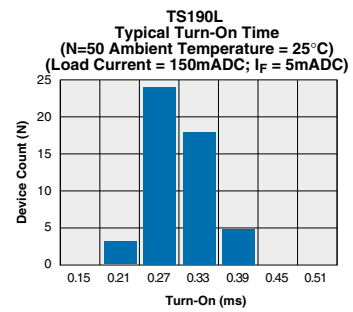
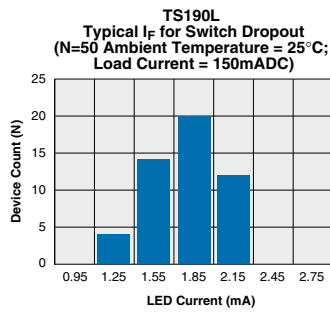
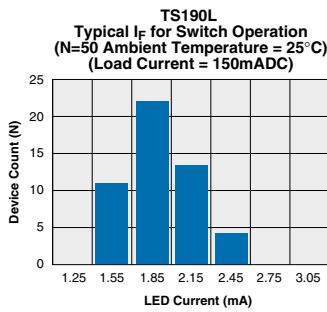
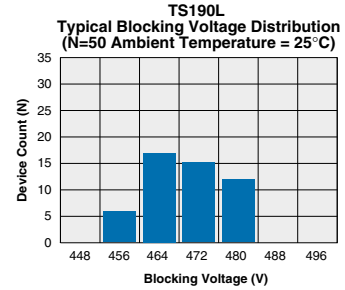
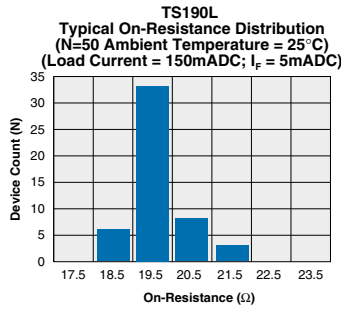
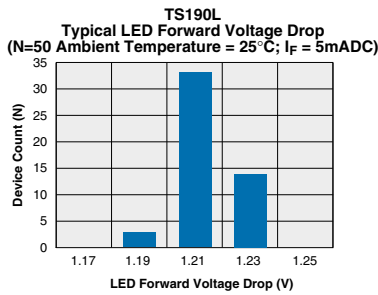

The Performance data shown in the graphs above is typical of device performance. For guaranteed parameters not indicated in the written specifications, please contact our application department.

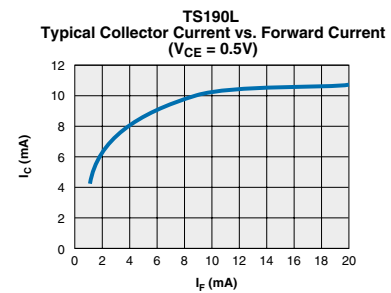
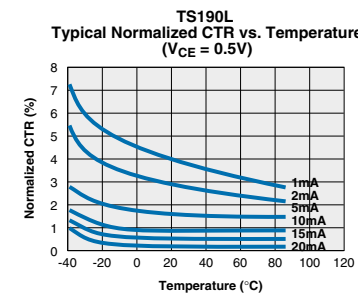
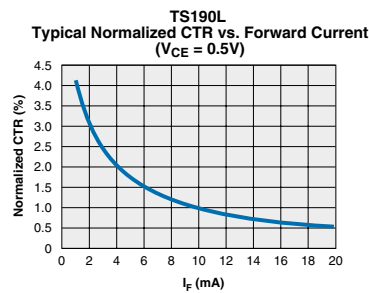
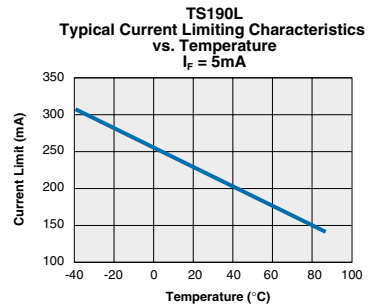
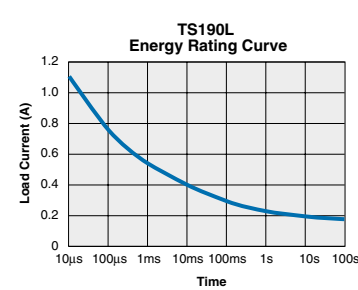
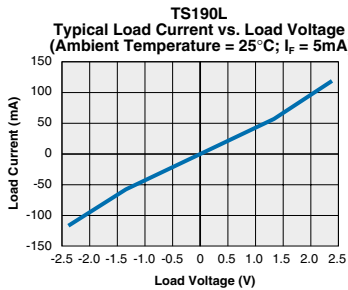
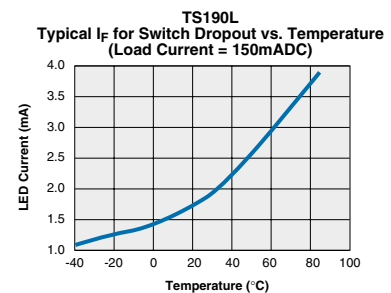
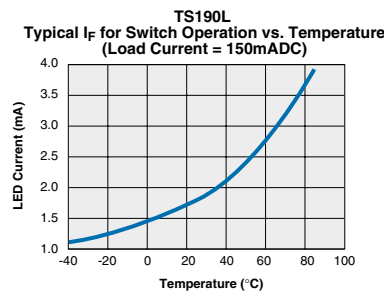
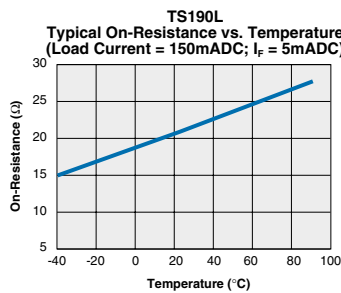
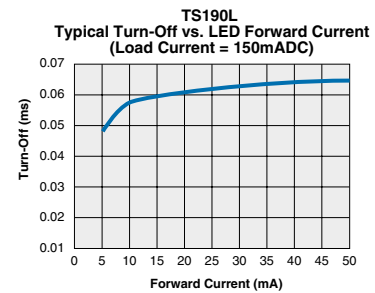
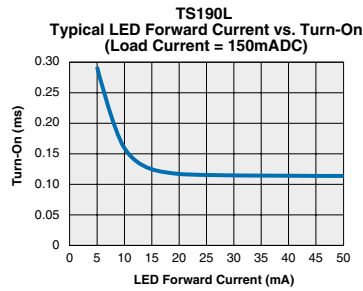
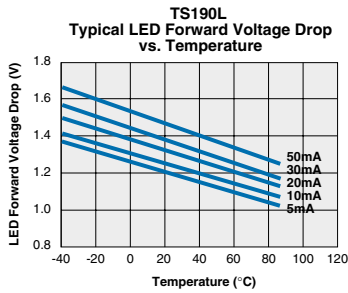
PERFORMANCE DATA*

*The Performance data shown in the graphs above is typical of device performance. For guaranteed parameters not indicated in the written specifications, please contact our application department.

Mechanical Dimensions

8 Pin DIP Through Hole (Standard)

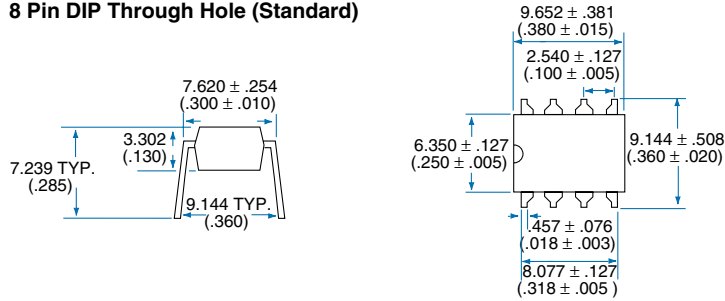

PC Board Pattern (Top View)

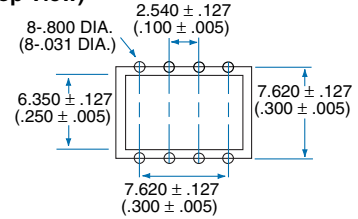

8 Pin DIP Surface Mount ("S" Suffix)

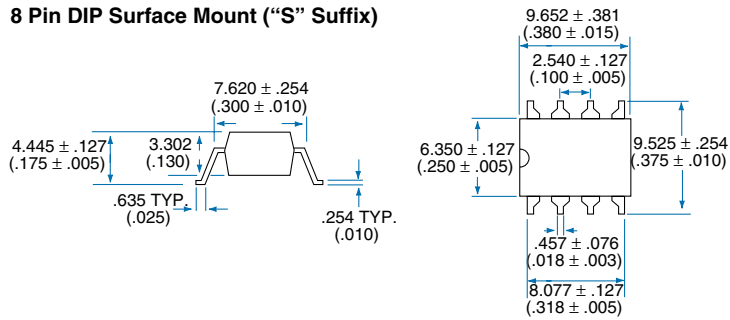

PC Board Pattern (Top View)

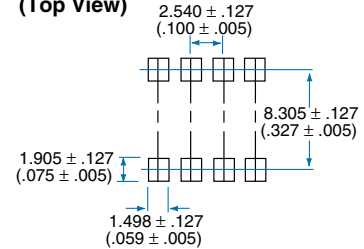

8 Pin Flatpack ("P" Suffix)

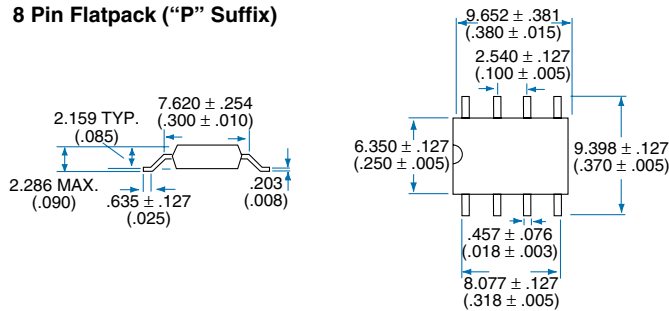

PC Board Pattern (Top View)

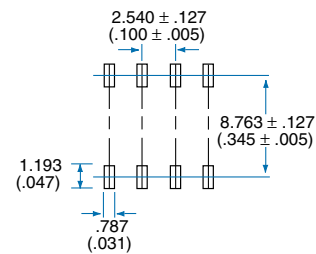

Dimensions
 mm
 (inches)

Mechanical Dimensions

Tape and Reel Packaging for 8 Pin Surface Mount Package

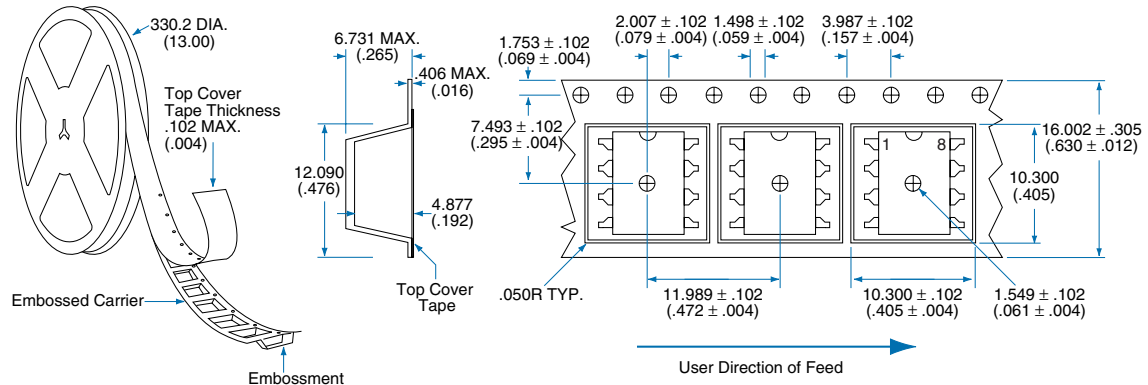

Tape and Reel Packaging for 8 Pin Flatpack Package

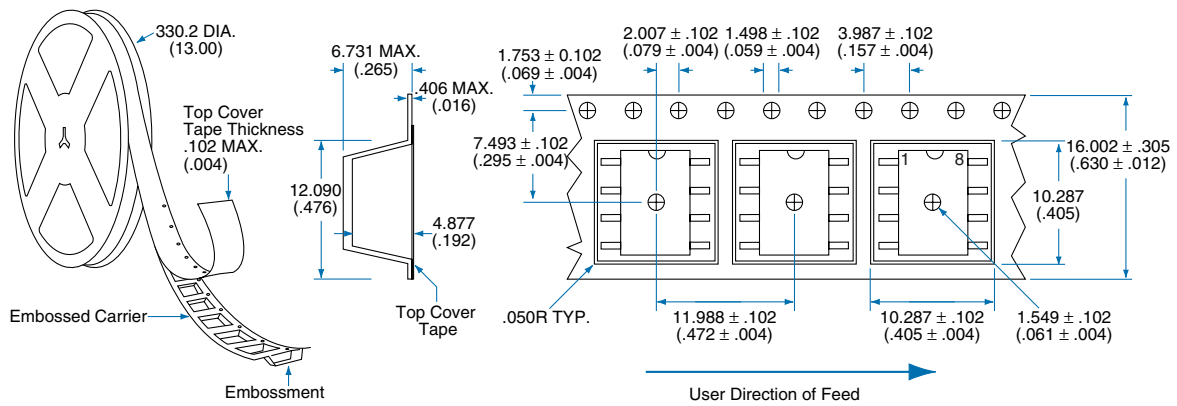

Dimensions
mm
(inches)

CLARE LOCATIONS

Clare Headquarters
78 Cherry Hill Drive
Beverly, MA 01915
Tel: 1-978-524-6700
Fax: 1-978-524-4900
Toll Free: 1-800-27-CLARE

Clare Micronix Division
145 Columbia
Aliso Viejo, CA 92656-1490
Tel: 1-949-831-4622
Fax: 1-949-831-4628

SALES OFFICES

AMERICAS

Americas Headquarters

Clare
78 Cherry Hill Drive
Beverly, MA 01915
Tel: 1-978-524-6700
Fax: 1-978-524-4900
Toll Free: 1-800-27-CLARE

Eastern Region

Clare
P.O. Box 856
Mahwah, NJ 07430
Tel: 1-201-236-0101
Fax: 1-201-236-8685
Toll Free: 1-800-27-CLARE

Central Region

Clare Canada Ltd.
3425 Harvester Road, Suite 202
Burlington, Ontario L7N 3N1
Tel: 1-905-333-9066
Fax: 1-905-333-1824

Western Region

Clare
1852 West 11th Street, #348
Tracy, CA 95376
Tel: 1-209-832-4367
Fax: 1-209-832-4732
Toll Free: 1-800-27-CLARE

Canada

Clare Canada Ltd.
3425 Harvester Road, Suite 202
Burlington, Ontario L7N 3N1
Tel: 1-905-333-9066
Fax: 1-905-333-1824

EUROPE

European Headquarters

CP Clare nv
Bampslaan 17
B-3500 Hasselt (Belgium)
Tel: 32-11-300868
Fax: 32-11-300890

France

Clare France Sales
Lead Rep
99 route de Versailles
91160 Champlan
France
Tel: 33 1 69 79 93 50
Fax: 33 1 69 79 93 59

Germany

Clare Germany Sales
ActiveComp Electronic GmbH
Mitterstrasse 12
85077 Manching
Germany
Tel: 49 8459 3214 10
Fax: 49 8459 3214 29

Italy

C.L.A.R.E.s.a.s.
Via C. Colombo 10/A
I-20066 Melzo (Milano)
Tel: 39-02-95737160
Fax: 39-02-95738829

Sweden

Clare Sales
Comptronic AB
Box 167
S-16329 Spånga
Tel: 46-862-10370
Fax: 46-862-10371

United Kingdom

Clare UK Sales
Marco Polo House
Cook Way
Bindon Road
Taunton
UK-Somerset TA2 6BG
Tel: 44-1-823 352541
Fax: 44-1-823 352797

ASIA/PACIFIC

Asian Headquarters

Clare
Room N1016, Chia-Hsin, Bldg II,
10F, No. 96, Sec. 2
Chung Shan North Road
Taipei, Taiwan R.O.C.
Tel: 886-2-2523-6368
Fax: 886-2-2523-6369

<http://www.clare.com>

Clare cannot assume responsibility for use of any circuitry other than circuitry entirely embodied in this Clare product. No circuit patent licenses nor indemnity are expressed or implied. Clare reserves the right to change the specification and circuitry, without notice at any time. The products described in this document are not intended for use in medical implantation or other direct life support applications where malfunction may result in direct physical harm, injury or death to a person.

Specification: DS-TS190L-R4
©Copyright 2000, Clare, Inc.
All rights reserved. Printed in USA.
2/27/01