

S200R Series

2W, Low Cost DIP, Single & Dual Output DC/DC Converters

Key Features

- Low Cost
- 500VDC Isolation
- MTBF > 800,000 Hours
- 40mV P-P Ripple and Noise
- Input 5, 12, 24 and 48VDC
- Output 5, 12, 15, ± 12 and ± 15 VDC
- Temperature Performance -25°C to $+71^{\circ}\text{C}$
- Short Circuit Protection
- UL 94V-0 Package Material
- Internal SMD Construction



Minimax's S200R Model 2W DC/DC's are specially designed to provide 40mA output ripple, continuous short circuit in a low-profile 24-pin DIP package.

The series consists of 20 models with input voltages of 5V, 12V, 24V and 48VDC which offers regulated output voltages of 5V, 12V, 15V, ± 12 V and ± 15 VDC.

The -25°C to $+71^{\circ}\text{C}$ operating temperature range makes it ideal for data communication equipments, mobile battery driven equipments, distributed power systems, telecommunication equipments, mixed analog/digital subsystems, automatic test instrumentation and industrial robot systems.

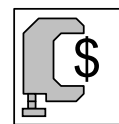

Low Cost

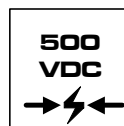

I/O Isolation

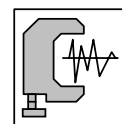

Low Noise

Block Diagram

Single Output

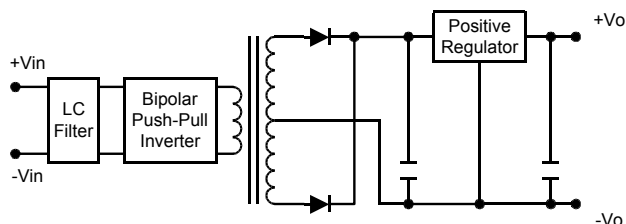

Dual Output

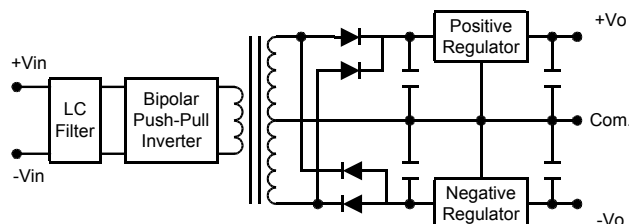

Model Selection Guide

| Model Number | Input Voltage | Output Voltage | Output Current | | Input Current | | Reflected Ripple Current | Efficiency |
|--------------|---------------------|----------------|----------------|------|---------------|-----------|--------------------------|------------|
| | | | Max. | Min. | @Max. Load | @No Load | | @Max. Load |
| | VDC | VDC | mA | mA | mA (Typ.) | mA (Typ.) | mA (Typ.) | % (Typ.) |
| S201R | 5 (4.5 ~ 5.5) | 5 | 400 | 0 | 800 | 80 | 80 | 50 |
| S202R | | 12 | 165 | | 730 | | | 54 |
| S203R | | 15 | 133 | | 690 | | | 57 |
| S204R | | ±12 | ±83 | | 740 | | | 53 |
| S205R | | ±15 | ±66 | | 770 | | | 51 |
| S206R | 12 (10.8 ~ 13.2) | 5 | 400 | 0 | 330 | 40 | 30 | 50 |
| S207R | | 12 | 165 | | 295 | | | 56 |
| S208R | | 15 | 133 | | 265 | | | 62 |
| S209R | | ±12 | ±83 | | 280 | | | 59 |
| S210R | | ±15 | ±66 | | 280 | | | 59 |
| S211R | 24 (21.6 ~ 26.4) | 5 | 400 | 0 | 163 | 20 | 15 | 51 |
| S212R | | 12 | 165 | | 135 | | | 61 |
| S213R | | 15 | 133 | | 135 | | | 61 |
| S214R | | ±12 | ±83 | | 135 | | | 61 |
| S215R | | ±15 | ±66 | | 135 | | | 61 |
| S216R | 48 (43.2 ~ 52.8) | 5 | 400 | 0 | 83 | 10 | 10 | 50 |
| S217R | | 12 | 165 | | 70 | | | 59 |
| S218R | | 15 | 133 | | 70 | | | 59 |
| S219R | | ±12 | ±83 | | 80 | | | 51 |
| S220R | | ±15 | ±66 | | 80 | | | 51 |

Absolute Maximum Ratings

| Parameter | Min. | Max. | Unit | |
|--|--------------------|-------|------|-----|
| Input Surge Voltage (1000 mS) | 5VDC Input Models | -0.7 | 7.5 | VDC |
| | 12VDC Input Models | -0.7 | 15 | VDC |
| | 24VDC Input Models | -0.7 | 30 | VDC |
| | 48VDC Input Models | -0.7 | 55 | VDC |
| Lead Temperature (1.5mm from case for 10 Sec.) | --- | 260 | °C | |
| Internal Power Dissipation | --- | 3,000 | mW | |

Exceeding the absolute maximum ratings of the unit could cause damage. These are not continuous operating ratings.

Notes :

- Specifications typical at Ta=+25°C, resistive load, nominal input voltage, rated output current unless otherwise noted.
- Transient recovery time is measured to within 1% error band for a step change in output load of 50% to 100%.
- Ripple & Noise measurement bandwidth is 0-20 MHz.
- All DC/DC converters should be externally fused at the front end for protection.
- Other input and output voltage may be available, please contact factory.
- Specifications subject to change without notice.

Environmental Specifications

| Parameter | Conditions | Min. | Max. | Unit |
|-----------------------|---------------------|------|------|------|
| Operating Temperature | Ambient | -25 | +71 | °C |
| Operating Temperature | Case | -25 | +90 | °C |
| Storage Temperature | | -40 | +125 | °C |
| Humidity | | --- | 95 | % |
| Cooling | Free-Air Convection | | | |

Input Specifications

| Parameter | Model | Min. | Typ. | Max. | Unit |
|--------------------------------|------------------|-----------|------|------|------|
| Input Voltage Range | 5V Input Models | 4.5 | 5 | 5.5 | VDC |
| | 12V Input Models | 10.8 | 12 | 13.2 | |
| | 24V Input Models | 21.6 | 24 | 26.4 | |
| | 48V Input Models | 43.2 | 48 | 52.8 | |
| Reverse Polarity Input Current | All Models | --- | --- | 0.5 | A |
| Short Circuit Input Power | | --- | --- | 2000 | mW |
| Input Filter | | Pi Filter | | | |

Output Specifications

| Parameter | Conditions | Min. | Typ. | Max. | Unit |
|------------------------------|-----------------------------|------|-------|-------|--------|
| Output Voltage Accuracy | | --- | ±2.0 | ±4.0 | % |
| Output Voltage Balance | Dual Output, Balanced Loads | --- | ±1.0 | ±3.0 | % |
| Line Regulation | Vin=Min. to Max. | --- | ±0.2 | ±0.5 | % |
| Load Regulation | Io=10% to 100% | --- | ±0.2 | ±0.5 | % |
| Ripple & Noise (20MHz) | | --- | 40 | 50 | mV P-P |
| Ripple & Noise (20MHz) | Over Line, Load & Temp. | --- | --- | 75 | mV P-P |
| Ripple & Noise (20MHz) | | --- | --- | 5 | mV rms |
| Over Load | | 120 | --- | --- | % |
| Transient Recovery Time | 50% Load Step Change | --- | --- | 50 | µs |
| Transient Response Deviation | | --- | --- | ±6 | % |
| Temperature Coefficient | | --- | ±0.01 | ±0.02 | %/°C |
| Output Short Circuit | Continuous | | | | |

General Specifications

| Parameter | Conditions | Min. | Typ. | Max. | Unit |
|-------------------------|-------------------------------------|------|------|------|---------|
| Isolation Voltage Rated | 60 Seconds | 500 | --- | --- | VDC |
| Isolation Test Voltage | Flash Tested for 1 Second | 550 | --- | --- | VDC |
| Isolation Resistance | 500VDC | 1000 | --- | --- | MΩ |
| Isolation Capacitance | 100KHz, 1V | --- | 100 | 150 | pF |
| Switching Frequency | | 40 | 80 | --- | KHz |
| MTBF | MIL-HDBK-217F @ 25°C, Ground Benign | 800 | --- | --- | K Hours |

Capacitive Load

| Models by Vout | 5V | 12V | 15V | ±12V # | ±15V # | Unit |
|-------------------------|-----|-----|-----|--------|--------|------|
| Maximum Capacitive Load | 470 | 470 | 470 | 220 | 220 | µF |

For each output

Input Fuse Selection Guide

| 5V Input Models | 12V Input Models | 24V Input Models | 48V Input Models |
|-------------------------|------------------------|------------------------|------------------------|
| 1500mA Slow – Blow Type | 700mA Slow – Blow Type | 350mA Slow – Blow Type | 135mA Slow – Blow Type |

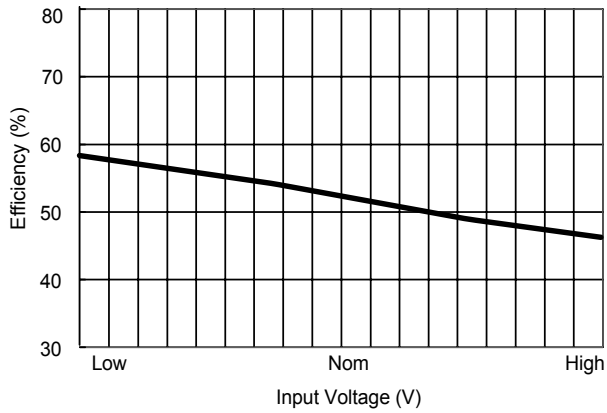

Efficiency vs Input Voltage (Single Output)

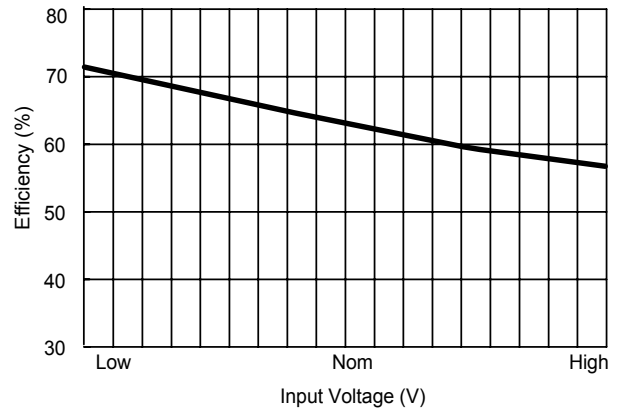

Efficiency vs Input Voltage (Dual Output)

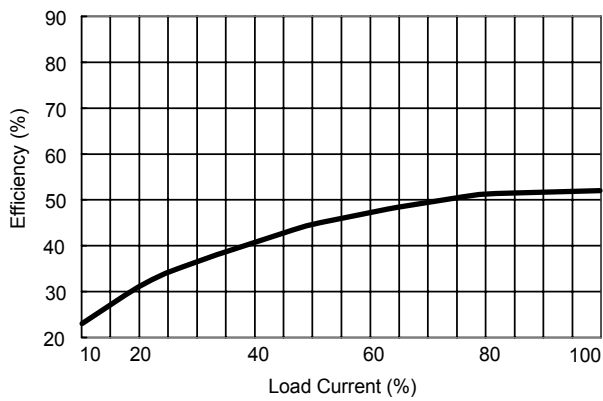

Efficiency vs Output Load (Single Output)

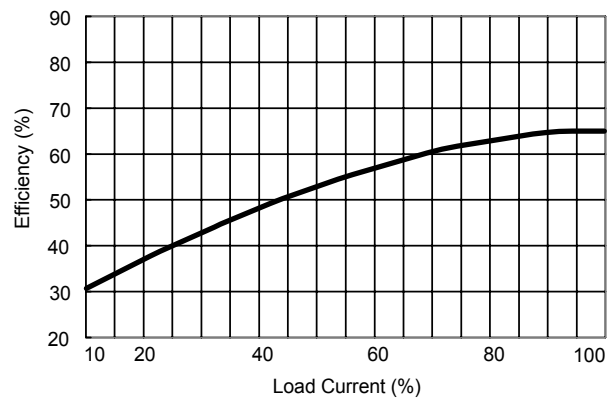

Efficiency vs Output Load (Dual Output)

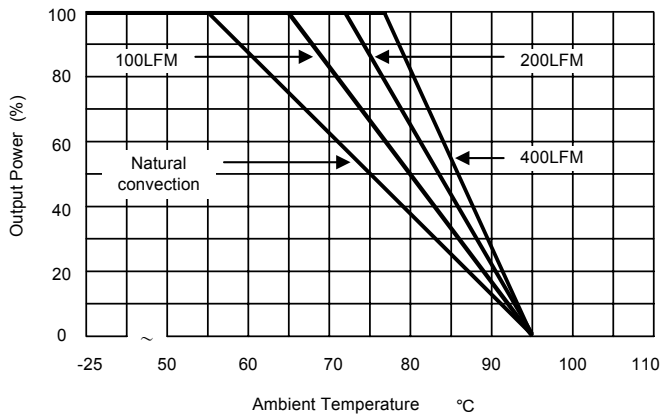

Derating Curve (5V output only)

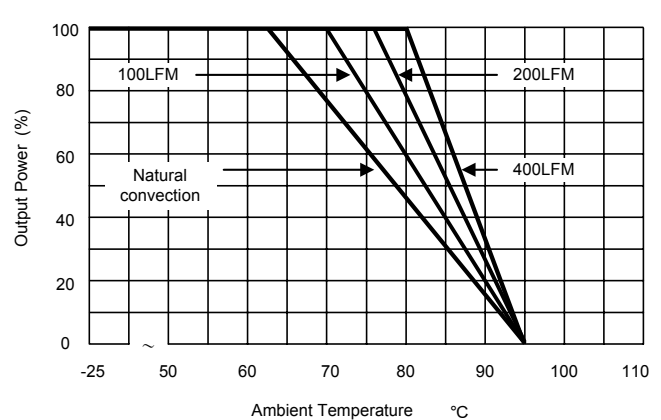

Derating Curve (all other output)

Test Configurations

Input Reflected-Ripple Current Test Setup

Input reflected-ripple current is measured with an inductor L_{in} (4.7uH) and C_{in} (220uF, ESR < 1.0Ω at 100 KHz) to simulate source impedance.

Capacitor C_{in} , offsets possible battery impedance.

Current ripple is measured at the input terminals of the module, measurement bandwidth is 0–500 KHz.

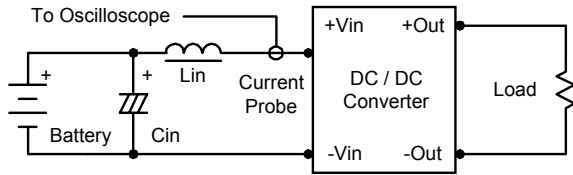

In applications where power is supplied over long lines and output loading is high, it may be necessary to use a capacitor at the input to ensure startup.

Capacitor mounted close to the power module helps ensure stability of the unit, it is recommended to use a good quality low Equivalent Series Resistance (ESR < 1.0Ω at 100 KHz) capacitor of a 2.2uF for the 5V input devices, a 1.0uF for the 12V input devices and a 0.47uF for the 24V and 48V devices.

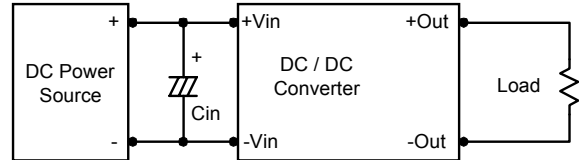

Peak-to-Peak Output Noise Measurement Test

Use a C_{out} 0.33uF ceramic capacitor.

Scope measurement should be made by using a BNC socket, measurement bandwidth is 0–20 MHz. Position the load between 50 mm and 75 mm from the DC/DC Converter.

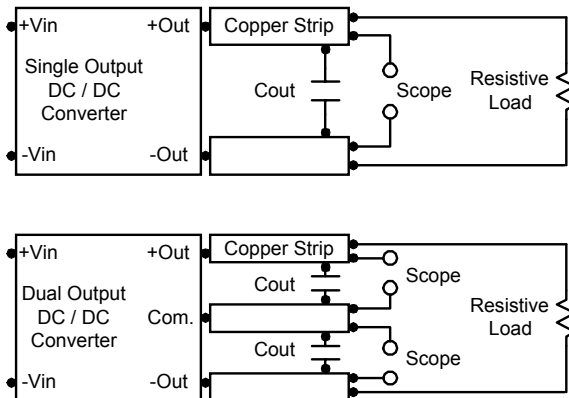

Output Ripple Reduction

A good quality low ESR capacitor placed as close as practicable across the load will give the best ripple and noise performance.

To reduce output ripple, it is recommended to use 1.5uF capacitors at the output.

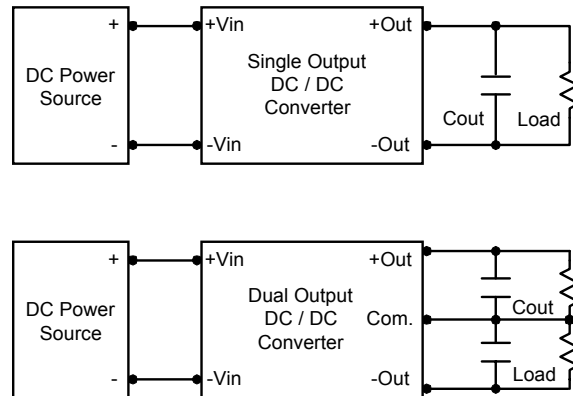

Design & Feature Considerations

Maximum Capacitive Load

The S200R series has limitation of maximum connected capacitance at the output.

The power module may be operated in current limiting mode during start-up, affecting the ramp-up and the startup time.

For optimum performance we recommend 220uF maximum capacitive load for dual outputs and 470uF capacitive load for single outputs.

The maximum capacitance can be found in the data sheet.

Input Source Impedance

The power module should be connected to a low ac-impedance input source. Highly inductive source impedances can affect the stability of the power module.

Thermal Considerations

Many conditions affect the thermal performance of the power module, such as orientation, airflow over the module and board spacing. To avoid exceeding the maximum temperature rating of the components inside the power module, the case temperature must be kept below 90°C.

The derating curves are determined from measurements obtained in an experimental apparatus.

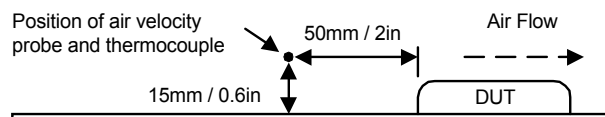

Mechanical Dimensions

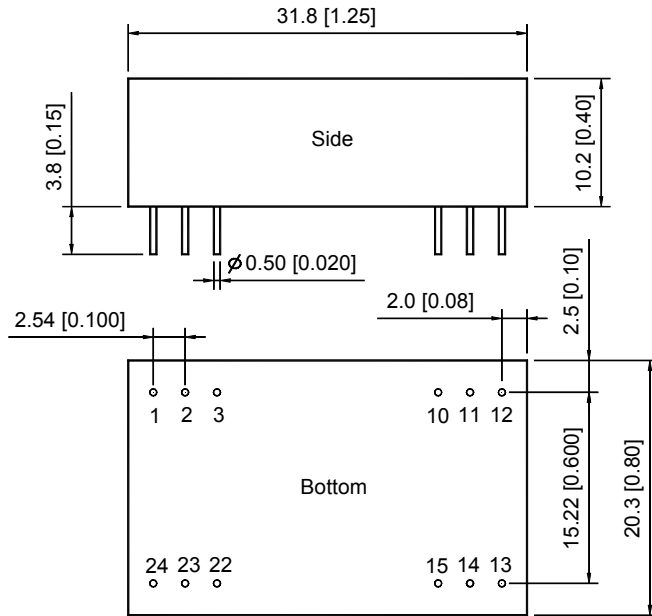

| Tolerance | Millimeters | Inches |
|-----------|-------------|-------------|
| | X.X±0.25 | X.XX±0.01 |
| | X.XX±0.13 | X.XXX±0.005 |
| Pin | ±0.05 | ±0.002 |

Connecting Pin Patterns

Top View (2.54 mm / 0.1 inch grids)

Single Output

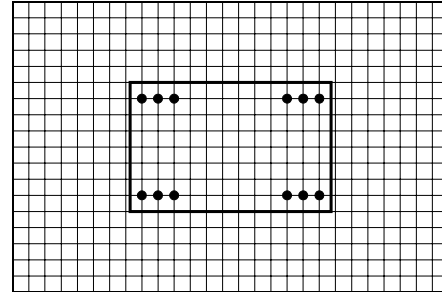

Dual Output

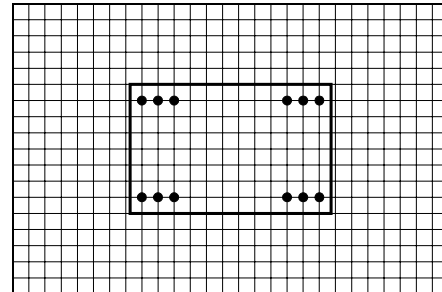

Pin Connections

| Pin | Single Output | Dual Output |
|-----|---------------|-------------|
| 1 | +Vin | +Vin |
| 2 | NC | -Vout |
| 3 | NC | Common |
| 10 | -Vout | Common |
| 11 | +Vout | +Vout |
| 12 | -Vin | -Vin |
| 13 | -Vin | -Vin |
| 14 | +Vout | +Vout |
| 15 | -Vout | Common |
| 22 | NC | Common |
| 23 | NC | -Vout |
| 24 | +Vin | +Vin |

NC: No Connection

Physical Characteristics

Case Size : 31.8×20.3×10.2 mm
1.25×0.80×0.40 inches

Case Material : Non-Conductive Black Plastic

Weight : 12.1g

Flammability : UL94V-0

The S200R converter is encapsulated in a low thermal resistance molding compound that has excellent resistance/electrical characteristics over a wide temperature range or in high humidity environments. The encapsulant and unit case are both rated to UL 94V-0 flammability specifications. Leads are tin plated for improved solderability.