

DomiLED InGaN – Reverse Gull-wing

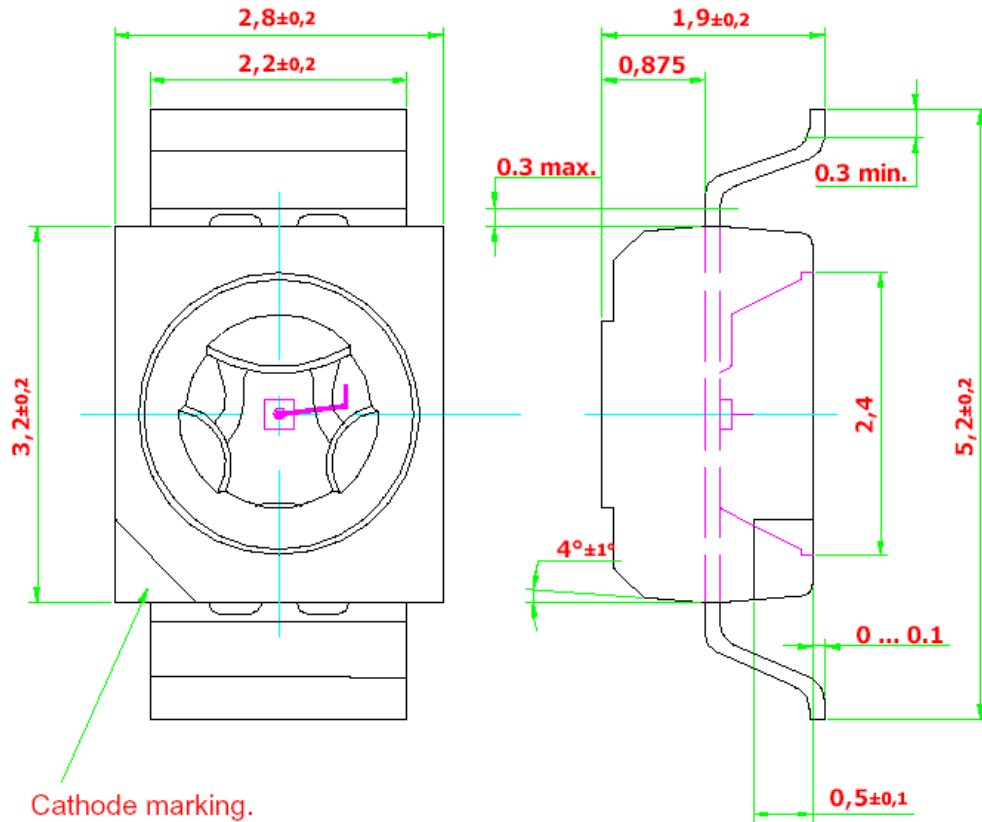

- High brightness surface mount LED.
- Based on InGaN technology.
- 120° viewing angle.
- Small package outline (LxWxH) of 2.8 x 3.2 x 1.8 mm.
- Qualified according to JEDEC moisture sensitivity Level 2.
- Compatible to both IR reflow soldering and TTW soldering.

DOMINANT Semiconductors

Part Ordering Number	Chip Technology / Color	Viewing angle	Luminous Intensity @ If = 20mA lv (mcd)
DDB-CRS-PQ2-1 <ul style="list-style-type: none"> • DDB-CRS-P1 • DDB-CRS-P2 • DDB-CRS-Q1 • DDB-CRS-Q2 	InGaN / Blue, 470 nm	120	45.0 ... 112.5 45.0 ... 56.0 56.0 ... 71.5 71.5 ... 90.0 90.0 ... 112.5
DDB-SRS-QR2-1 <ul style="list-style-type: none"> • DDB-SRS-Q1 • DDB-SRS-Q2 • DDB-SRS-R1 • DDB-SRS-R2 			71.5 ... 180.0 71.5 ... 90.0 90.0 ... 112.5 112.5 ... 140.0 140.0 ... 180.0
DDB-URS-RS1-1 <ul style="list-style-type: none"> • DDB-URS-R1 • DDB-URS-R2 • DDB-URS-S1 			112.5 ... 224.0 112.5 ... 140.0 140.0 ... 180.0 180.0 ... 224.0
DDC-CRS-RS2-1 <ul style="list-style-type: none"> • DDC-CRS-R1 • DDC-CRS-R2 • DDC-CRS-S1 • DDC-CRS-S2 	InGaN / Cyan, 505 nm	120	112.5 ... 285.0 112.5 ... 140.0 140.0 ... 180.0 180.0 ... 224.0 224.0 ... 285.0
DDC-SRS-ST2-1 <ul style="list-style-type: none"> • DDC-SRS-S1 • DDC-SRS-S2 • DDC-SRS-T1 • DDC-SRS-T2 			180.0 ... 450.0 180.0 ... 224.0 224.0 ... 285.0 285.0 ... 355.0 355.0 ... 450.0
DDT-CRS-RS2-1 <ul style="list-style-type: none"> • DDT-CRS-R1 • DDT-CRS-R2 • DDT-CRS-S1 • DDT-CRS-S2 	InGaN / True Green, 525 nm	120	112.5 ... 285.0 112.5 ... 140.0 140.0 ... 180.0 180.0 ... 224.0 224.0 ... 285.0
DDT-SRS-ST2-1 <ul style="list-style-type: none"> • DDT-SRS-S1 • DDT-SRS-S2 • DDT-SRS-T1 • DDT-SRS-T2 			180.0 ... 450.0 180.0 ... 224.0 224.0 ... 285.0 285.0 ... 355.0 355.0 ... 450.0
DDT-URS-TU2-1 <ul style="list-style-type: none"> • DDT-URS-T1 • DDT-URS-T2 • DDT-URS-U1 • DDT-URS-U2 			285.0 ... 715.0 285.0 ... 355.0 355.0 ... 450.0 450.0 ... 560.0 560.0 ... 715.0

Part Ordering Number	Chip Technology / Color	Viewing angle	Luminous Intensity @ If = 20mA lv (mcd)
DDW-CRD-RS2-1 <ul style="list-style-type: none"> • DDW-CRD-R1 • DDW-CRD-R2 • DDW-CRD-S1 • DDW-CRD-S2 	InGaN / White	120	112.5 ... 285.0 112.5 ... 140.0 140.0 ... 180.0 180.0 ... 224.0 224.0 ... 285.0
DDW-CRD-ST1-1 <ul style="list-style-type: none"> • DDW-CRD-S1 • DDW-CRD-S2 • DDW-CRD-T1 			180.0 ... 355.0 180.0 ... 224.0 224.0 ... 285.0 285.0 ... 355.0
DDW-SRD-ST2-1 <ul style="list-style-type: none"> • DDW-SRD-S1 • DDW-SRD-S2 • DDW-SRD-T1 • DDW-SRD-T2 			180.0 ... 450.0 180.0 ... 224.0 224.0 ... 285.0 285.0 ... 355.0 355.0 ... 450.0
DDW-URD-TU2-1 <ul style="list-style-type: none"> • DDW-URD-T1 • DDW-URD-T2 • DDW-URD-U1 • DDW-URD-U2 			285.0 ... 715.0 285.0 ... 355.0 355.0 ... 450.0 450.0 ... 560.0 560.0 ... 715.0
DDW-URD-UV1-1 <ul style="list-style-type: none"> • DDW-URD-U1 • DDW-URD-U2 • DDW-URD-V1 			450.0 ... 900.0 450.0 ... 560.0 560.0 ... 715.0 715.0 ... 900.0

NOTE:

1. All part number above comes in a quantity of 2000 units per reel.
2. Other luminous intensity groups are also available upon request.
3. Luminous intensity is measured with an accuracy of $\pm 11\%$.
4. Wavelength binning is carried for all units as per the wavelength-binning table. Only one wavelength group is allowed for each reel.
5. An optional Vf binning is also available upon request. Binning scheme is as per following table.

DOMINANT Semiconductors

Wavelength Grouping.

Color	Group	Wavelength distribution (nm)
DDB; Blue	Full	464 - 476
	W	464 - 468
	X	468 - 472
	Y	472 - 476
DDC; Cyan	Full	499 - 511
	W	499 - 503
	X	503 - 507
	Y	507 - 511
DDT; True Green	Full	520 - 536
	W	520 - 524
	X	524 - 528
	Y	528 - 532
	Z	532 - 536

Dominant wavelength is measured with an accuracy of ± 1 nm.

DDW, White Color Grouping

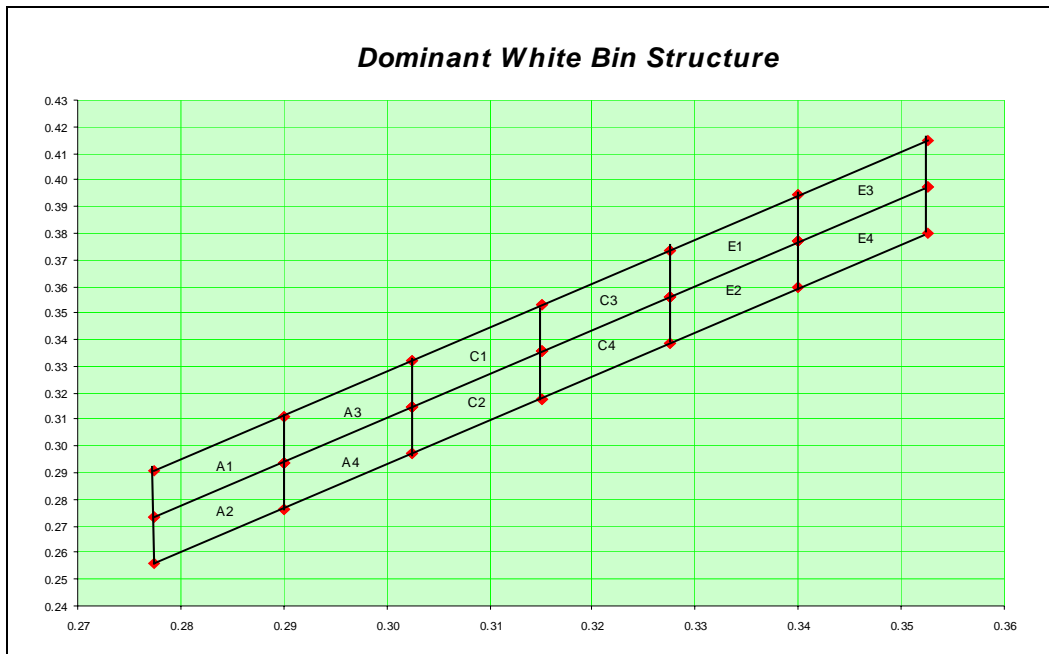

DOMINANT Semiconductors

Chromaticity coordinate groups are measured with an accuracy of ± 0.01 .

W					X						
Bin						Bin					
A1	Cx	0.2775	0.2900	0.2900	0.2775	E1	Cx	0.3275	0.3400	0.3400	0.3275
	Cy	0.2732	0.2939	0.3114	0.2907		Cy	0.3561	0.3768	0.3943	0.3736
A2	Cx	0.2775	0.2900	0.2900	0.2775	E2	Cx	0.3275	0.3400	0.3400	0.3275
	Cy	0.2557	0.2764	0.2939	0.2732		Cy	0.3386	0.3593	0.3768	0.3561
A3	Cx	0.2900	0.3025	0.3025	0.2900	E3	Cx	0.3400	0.3525	0.3525	0.3400
	Cy	0.2939	0.3146	0.3321	0.3114		Cy	0.3768	0.3975	0.4150	0.3943
A4	Cx	0.2900	0.3025	0.3025	0.2900	E4	Cx	0.3400	0.3525	0.3525	0.3400
	Cy	0.2764	0.2971	0.3146	0.2939		Cy	0.3593	0.3800	0.3975	0.3768
C1	Cx	0.3025	0.3150	0.3150	0.3025						
	Cy	0.3146	0.3354	0.3529	0.3321						
C2	Cx	0.3025	0.3150	0.3150	0.3025						
	Cy	0.2971	0.3179	0.3354	0.3146						
C3	Cx	0.3150	0.3275	0.3275	0.3150						
	Cy	0.3354	0.3561	0.3736	0.3529						
C4	Cx	0.3150	0.3275	0.3275	0.3150						
	Cy	0.3179	0.3386	0.3561	0.3354						

Vf Binning.

Vf Bin @ 20mA	Forward voltage (V)
Standard	3.35 ... 4.25
01	3.35 ... 3.65
02	3.65 ... 3.95
03	3.95 ... 4.25

Forward voltage, Vf is measured with an accuracy of ± 0.1 V.

Absolute Maximum Ratings.

	Maximum Value	Unit
DC forward current.	20	mA
Peak pulse current; ($t_p \leq 10 \mu s$, Duty cycle = 0.005)	200	mA
Reverse voltage.	5	V
LED junction temperature.	125	$^{\circ}C$
Operating temperature.	-40 ... +100	$^{\circ}C$
Storage temperature.	-40 ... +100	$^{\circ}C$
Power dissipation (at room temperature)	85	mW

Recommended Solder Pad

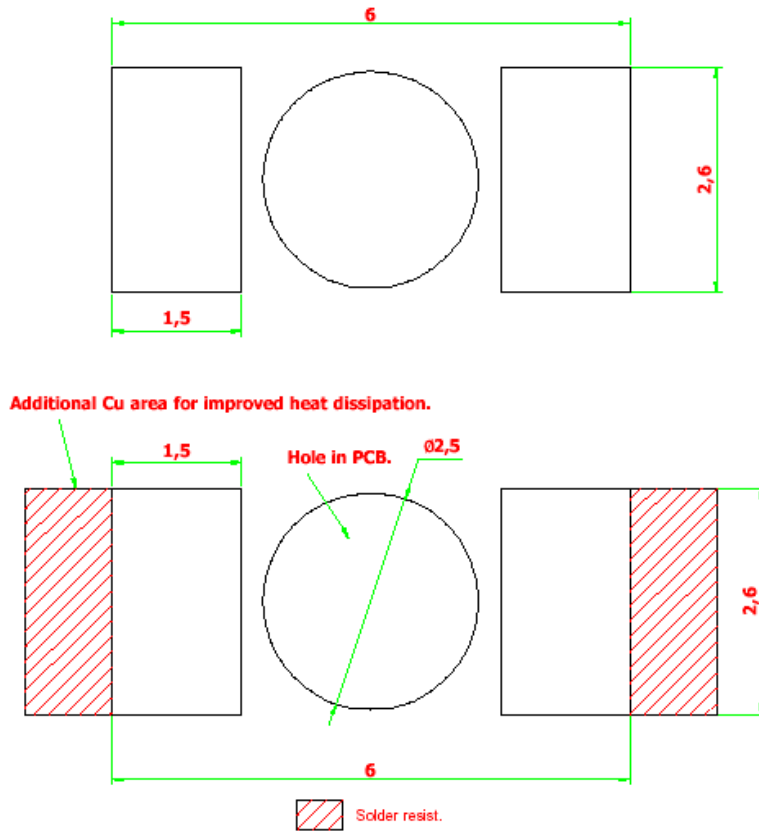

DOMINANT Semiconductors

Relative luminous intensity vs. forward current.

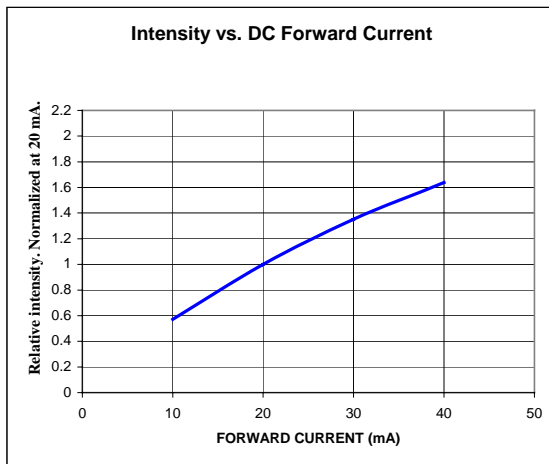

Forward current vs. forward voltage.

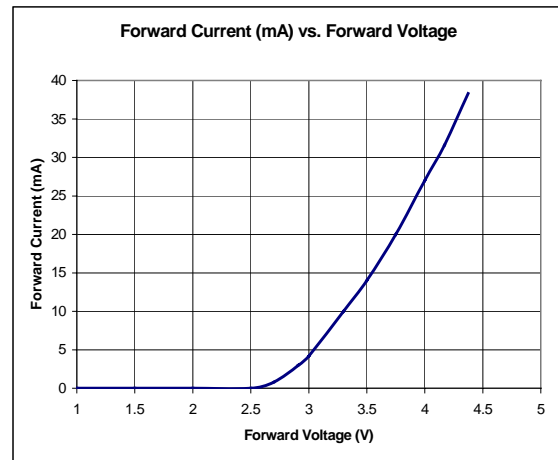

Radiation pattern.

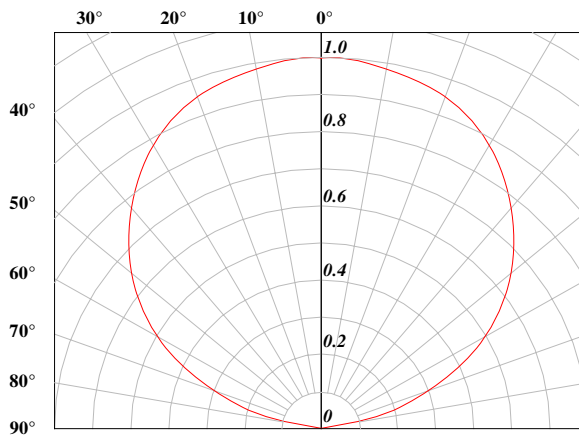

Maximum forward current vs. temperature.

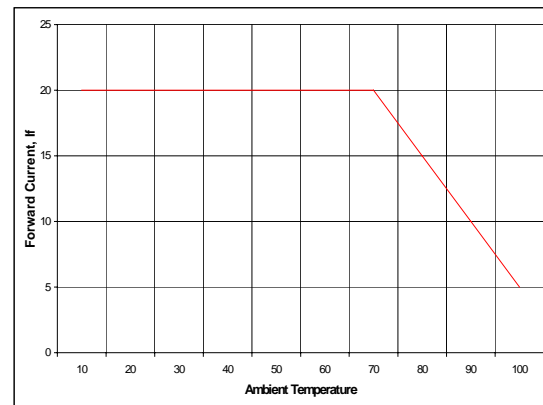

Relative Intensity vs. Wavelength

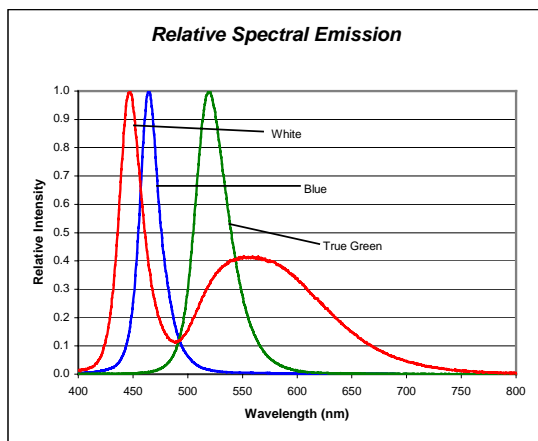

Dominant Wavelength vs. Forward Current

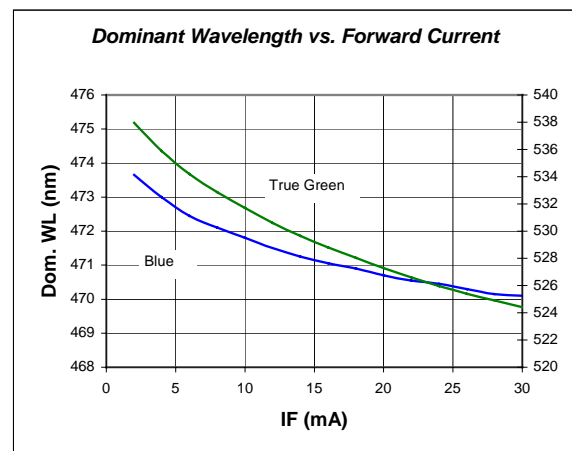

Taping And Orientation.

Reels come in quantity of 8000 units or 2000 units.

Reel diameters are 330 mm and 180 mm respectively.

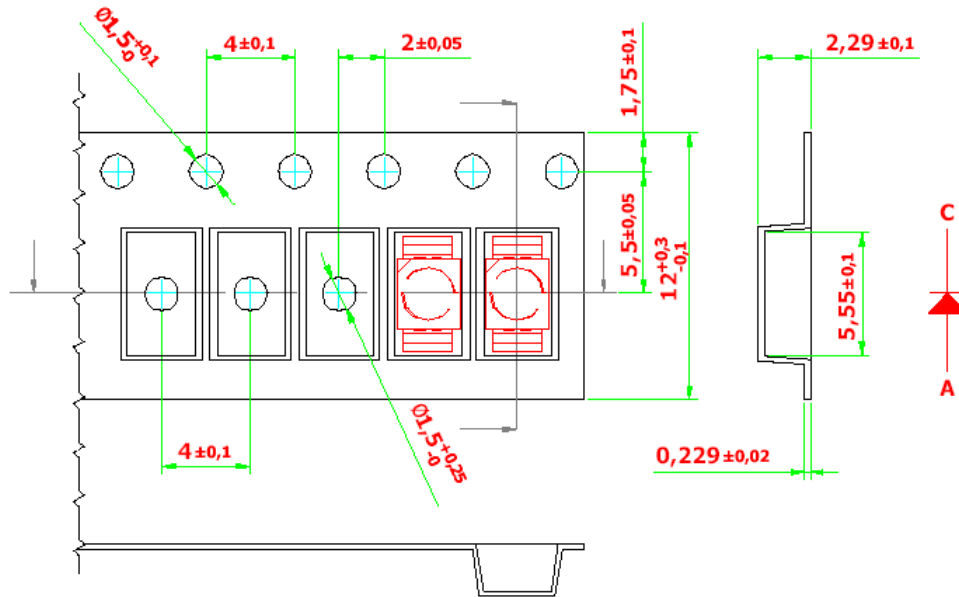

200 mm min. for $\varnothing 180$ reel.

480 mm min. for $\varnothing 180$ reel.

200 mm min. for $\varnothing 330$ reel.

960 mm min. for $\varnothing 330$ reel.

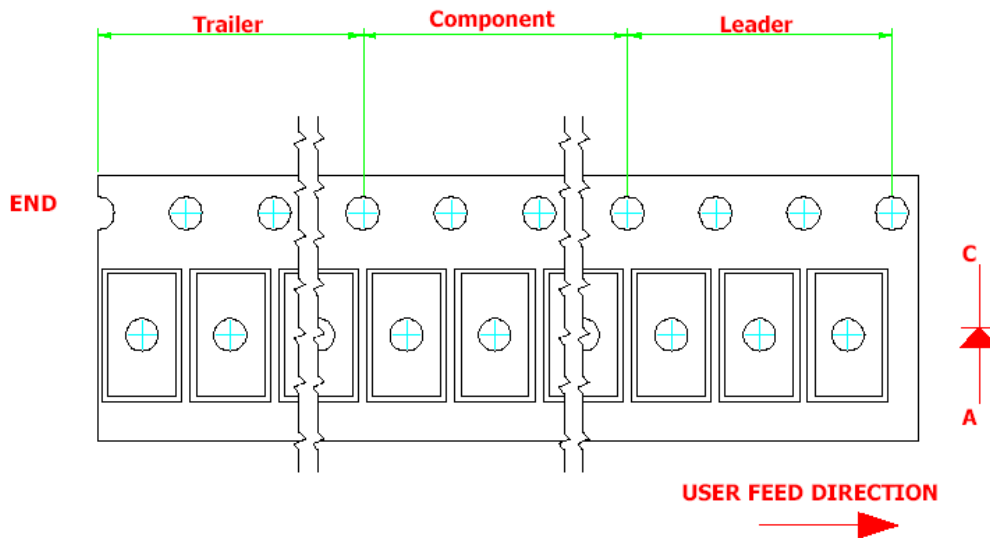

Recommended Sn-Pb IR-Reflow Soldering Profile.

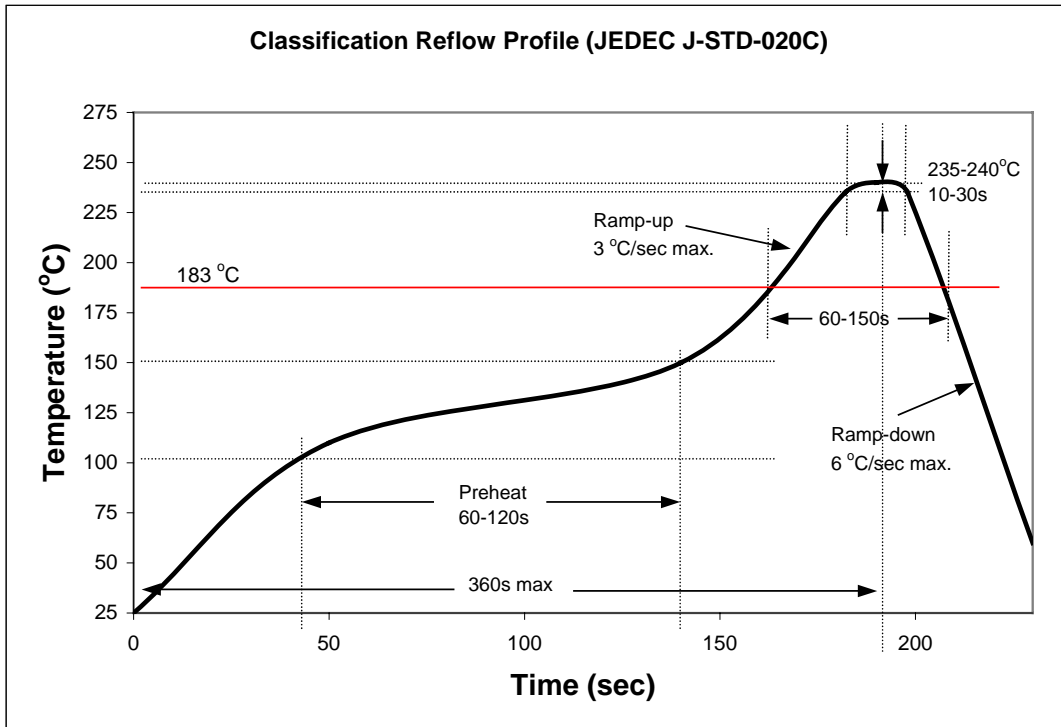

Recommended Pb Free IR-Reflow Soldering Profile.

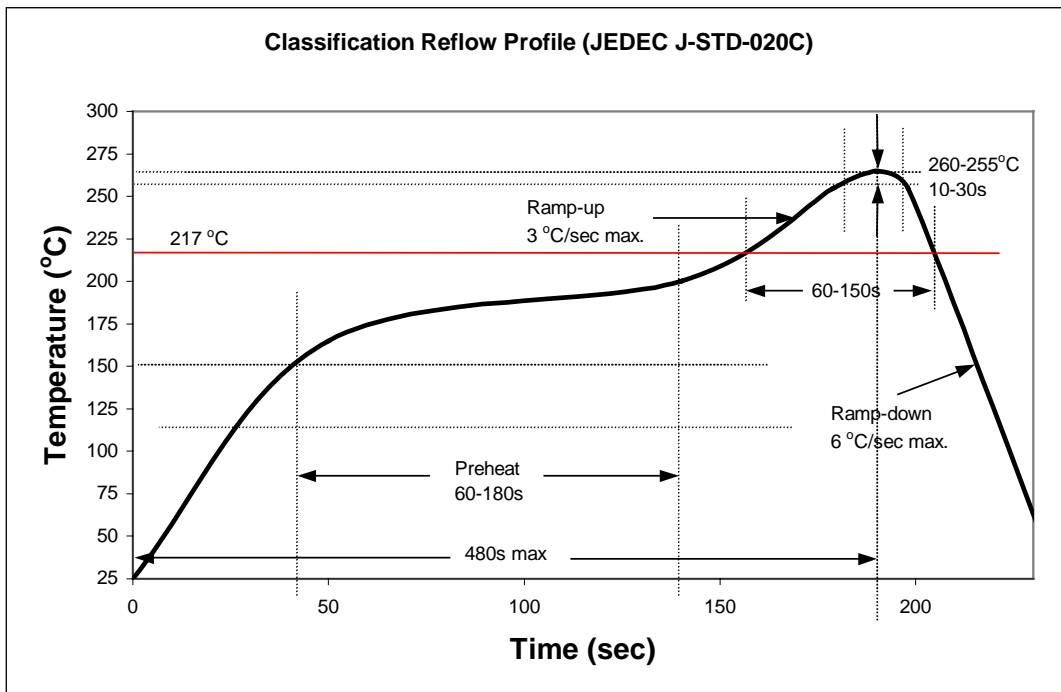

NOTE.

All the information published is considered to be reliable. However, DOMINANT Semiconductors does not assume any liability arising out of the application or use of any product described herein.

DOMINANT Semiconductors reserves the right to make changes at any time without notice to any products in order to improve reliability, function or design.

DOMINANT Semiconductors products are not authorized for use as critical components in life support devices or systems without the express written approval from the managing director of DOMINANT Semiconductors.