

ISOLATED DC/DC CONVERTERS

36 Vdc - 75 Vdc Input, 3.3 Vdc/15 A Output



Jul. 09, 2010

Bel Power Inc., a subsidiary of Bel Fuse Inc.

xRSB-50T03C

RoHS Compliant

Rev.B

Features

- Isolated
- High Efficiency
- Fixed Frequency (600 kHz)
- High Power Density
- Input Under Voltage Lockout
- Low Cost
- Positive/Negative Remote Sense
- Class 1, Category 2, Isolated DC/DC Converter (refer to IPC-9592)
- UL60950-1 Recognized (UL/cUL) (Pending)
- Output Over Voltage Shutdown
- Output Voltage Trim
- Over Temperature Protection
- SCP/OCP
- Basic Insulation
- Remote On/Off

Applications

- Networking
- Computers and peripherals
- Telecommunications

Description

The xRSB-50T03C is an isolated dc/dc converter that operates from a nominal 48 Vdc source. This unit will provide up to 50 W of output power from a nominal 48 Vdc input. This unit is designed to be highly efficient and low cost. Features include remote on/off, over current protection and under voltage lockout. The converter is provided in an industry standard sixteenth brick package.

Part Selection

Output Voltage	Input Voltage	Max. Output Current	Max. Output Power	Typical Efficiency	Model Number Active Low
3.3 Vdc	36 Vdc - 75 Vdc	15 A	50 W	89%	xRSB-50T03C

Notes: Add "G" suffix at the end of the model number to indicate Tray Packaging.

Part Number Explanation

$\frac{x}{1} \frac{R}{2} \frac{SB}{3} - \frac{50}{4} \frac{T}{5} \frac{03}{6} \frac{C}{7}$

- 1---"x" can be "0" or "S", "0" mean through hole mount and "S" mean surface mount
- 2---RoHS 6, change "R" to "7" means RoHS 5
- 3---Series name, 1/16 brick
- 4---Series code
- 5---Input range (36-75V)
- 6---Output voltage (3.3V)
- 7---Suffix

ISOLATED DC/DC CONVERTERS

36 Vdc - 75 Vdc Input, 3.3 Vdc/15 A Output



Jul. 09, 2010

Bel Power Inc., a subsidiary of Bel Fuse Inc.

Absolute Maximum Ratings

Parameter	Min	Typ	Max	Unit	Notes
Continuous non-operating Input Voltage	-0.3	-	80	V	
Input Transient Voltage	-	-	100	V	100mS maximum
Remote On/Off	-0.3	-	18	V	
I/O Isolation Voltage	-	-	1500	V	
Ambient Temperature	-40	-	85	°C	
Storage Temperature	-55	-	125	°C	

Note: Ratings used beyond the maximum ratings may cause a reliability degradation of the converter or may permanently damage the device.

Input Specifications

Parameter	Min	Typ	Max	Unit	Notes
Operating Input Voltage	36	48	75	V	
Input Current (full load)	-	-	2	A	
Input Current (no load)	-	70	120	mA	
Remote Off Input Current	-	1	3	mA	
Input Reflected Ripple Current (rms)	-	3	7	mA	With simulated source impedance of 10uH, 5Hz to 20MHz; use a 100uF/100V electrolytic capacitor with ESR=1 ohm max, at 200 kHz.
Input Reflected Ripple Current (pk-pk)	-	20	50	mA	
I ² t Inrush Current Transient	-	-	0.02	A ² s	
Turn-on Voltage Threshold	-	32	35	V	
Turn-off Voltage Threshold	30	31	-	V	

CAUTION: This converter is not internally fused. An input line fuse must be used in application.

Recommend a fast-acting fuse with maximum rating of 5A on system board. Refer to the fuse manufacture's datasheet for further information.

- Notes:** 1. This converter has internal L-C (1.0uH-1.0uF) filter.
2. All specifications are typical at 25 °C unless otherwise stated.

Output Specifications

Parameter	Min	Typ	Max	Unit	Notes
Output Voltage Set Point	3.25	3.30	3.35	V	V _{in} =48 V, I _o =50%Load
Load Regulation	-	±4	±9	mV	
Line Regulation	-	±3	±8	mV	
Regulation Over Temperature (-40deg.C-85deg.C)	-	±9	±16	mV	
Ripple and Noise (pk-pk)	-	55	90	mV	0-20MHz BW, with a 1µF ceramic capacitor and the minimum external cap at output
Ripple and Noise (rms)	-	12	25	mV	
Output Ripple and Noise(Pk-Pk) under worst case	-	-	100	mV	over all operating input voltage, load and ambient temperature

ISOLATED DC/DC CONVERTERS
36 Vdc - 75 Vdc Input, 3.3 Vdc/15 A Output



Jul. 09, 2010

Bel Power Inc., a subsidiary of Bel Fuse Inc.

Output Specifications (continued)

Parameter	Min	Typ	Max	Unit	Notes		
Output Current Range	0	-	15	A			
Output DC Current Limit	19	22	26	A			
Short Circuit Surge Transient	-	-	1	A ² s			
Rise Time	-	-	15	mS			
Turn on Time	-	35	70	mS	Enable form Vin		
	-	35	70	mS	Enable form ON/OFF		
Overshoot at Turn on	-	0	5	%			
Output Capacitance	3000	-	10000	uF			
Transient Response							
ΔV 50%~75% of Max Load	Overshoot	Vo= 3.3 V	-	150	250	mV	di/dt=0.1A/us, Vin=48Vdc, Ta=25°C, with a 1µF ceramic capacitor and the minimum external cap at output
	Settling Time		-	120	200	uS	
ΔV 75%~50% of Max Load	Overshoot		-	150	250	mV	
	Settling Time		-	120	200	uS	

Note: All specifications are typical at nominal input, full load at 25°C unless otherwise stated.

General Specifications

Parameter	Min	Typ	Max	Unit	Notes
Efficiency	86	89	-	%	Vin=48 V, full load.
Switching Frequency	-	600	-	kHz	
Over Temperature Protection	-	120	140	°C	
Over Voltage Protection (Static)	-	4.29	5.28	V	
Weight	-	13	-	g	
FIT	TBD			-	Calculated Per Bell Core SR-332 (Vin=48V, Vo=3.3V, Io=80%load, Ta = 25 °C, FIT=10 ⁹ /MTBF)
Dimensions	Inches (L x W x H)			-	0RSB-50T03C
	Millimeters (L x W x H)				
Dimensions	Inches (L x W x H)			-	SRSB-50T03C
	Millimeters (L x W x H)				
Isolation characteristics					
Input to Output	-	-	1500	V	
Isolation Resistance	10M	-	-	Ohm	
Isolation Capacitance	-	3900	-	pF	

Note: All specifications are typical at 25 °C unless otherwise stated.

ISOLATED DC/DC CONVERTERS
 36 Vdc - 75 Vdc Input, 3.3 Vdc/15 A Output



Jul. 09, 2010

Bel Power Inc., a subsidiary of Bel Fuse Inc.

Efficiency Data

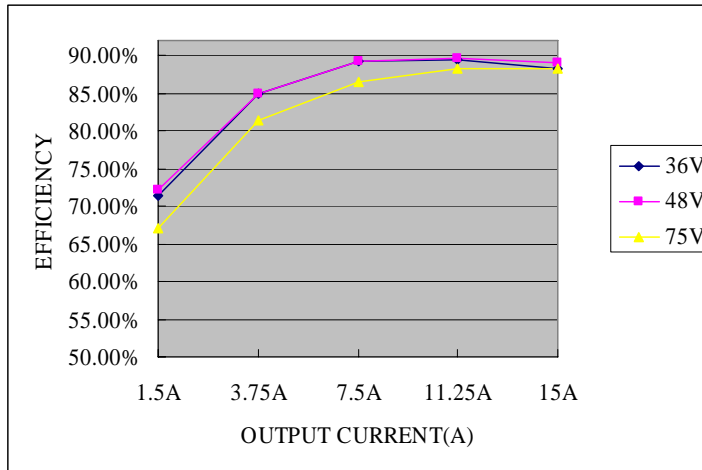

Thermal Derating Curve

Maximum junction temperature of semiconductors derated to 120 degree C.

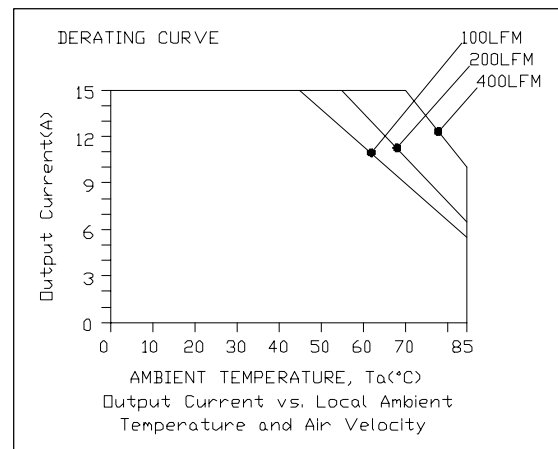
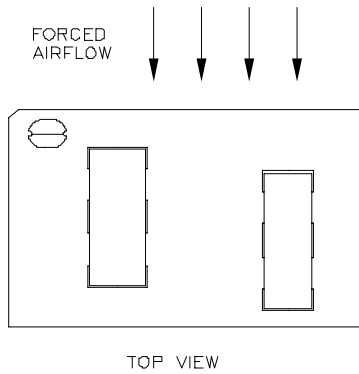

ISOLATED DC/DC CONVERTERS

36 Vdc - 75 Vdc Input, 3.3 Vdc/15 A Output



Jul. 09, 2010

Bel Power Inc., a subsidiary of Bel Fuse Inc.

Thermal Derating Curve (continued)

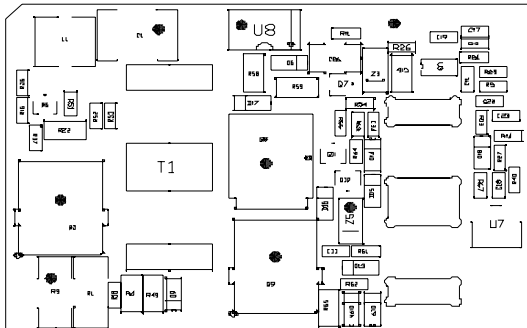

Temperature reference points on top side

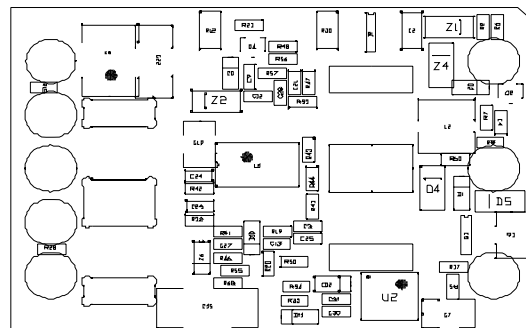

Temperature reference points on bottom side

Ripple and Noise Waveform

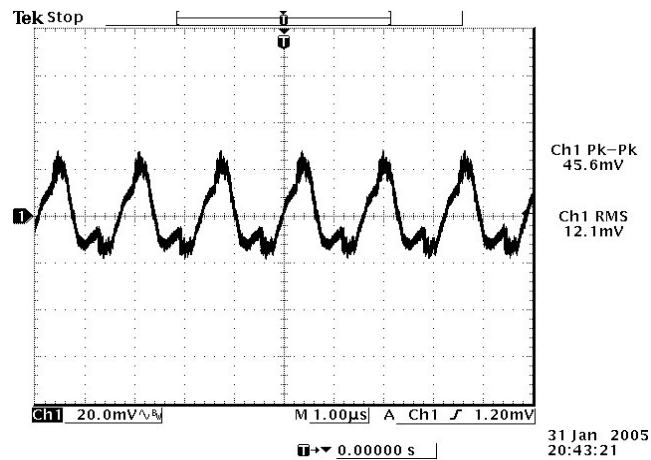

48 Vdc input, 3.3 Vdc/15 A output

Note: Ripple and noise at full load, and with a 1µF ceramic cap and a 3000 µF cap at output, $T_a=25$ deg C.

ISOLATED DC/DC CONVERTERS

36 Vdc - 75 Vdc Input, 3.3 Vdc/15 A Output



Jul. 09, 2010

Bel Power Inc., a subsidiary of Bel Fuse Inc.

Transient Response Waveforms

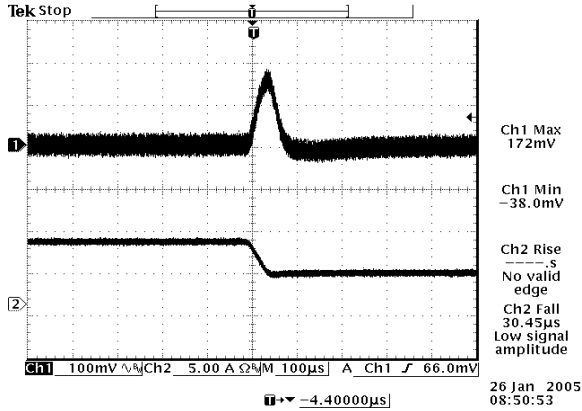

50%-75% Load Transients at Vin=48 V

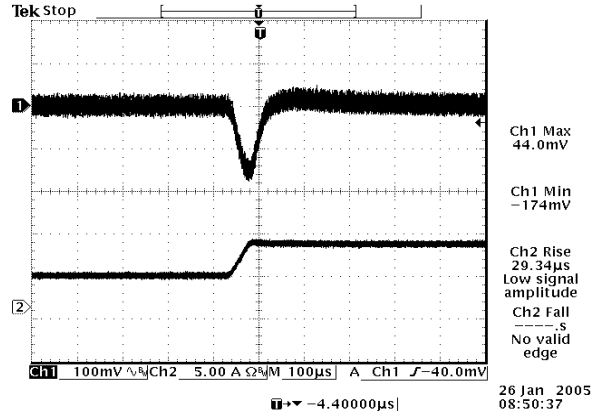

75%-50% Load Transients at Vin=48 V

Note: Transient response at di/dt=0.1A/us, with 1uF ceramic cap and 3000uF cap at output, and Ta=25 deg C.

Remote On/Off

Parameter	Min	Typ	Max	Unit	Notes
Signal Low (Unit On)	Active Low	-	0.8	V	The remote on/off pin open, Unit off.
Signal High (Unit Off)					
Current Sink	0	-	1	mA	

Recommended remote on/off circuit for active low

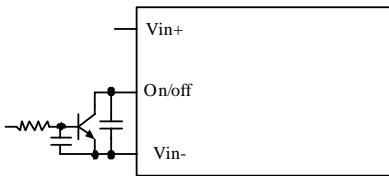

Control with open collector/drain circuit

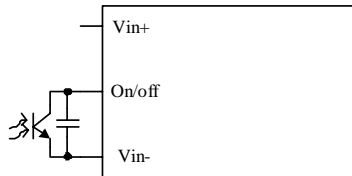

Control with photocoupler circuit

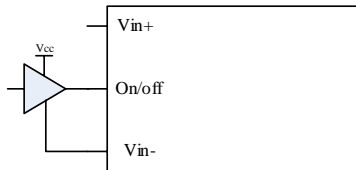

Control with logic circuit

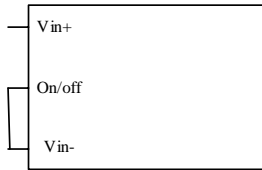

Permanently on

Output Trim Equations

Equations for calculating the trim resistor are shown below. The Trim Down resistor should be connected between the Trim pin and GND pin. The Trim Up resistor should be connected between the Trim pin and the Vout pin. Only one of the resistors should be used for any given application.

Minimum trim down voltage is 2.97V

Maximum trim up voltage is 3.63V.

The total voltage increased by trim and remote sense should not exceed 10% of the nominal output voltage.

$$R_{trimdown} = \frac{511}{|\delta|} - 10.22 [k\Omega]$$

$$R_{trimup} = \frac{(100 + \delta) \cdot V_o \cdot 5.11 - 626}{1.225 \cdot \delta} - 10.22 [k\Omega]$$

Note:

$$\delta = \frac{(V_o_{req} - V_o)}{V_o} \times 100 [\%]$$

V_o_{req} = Desired (trimmed) output voltage [V]

Output voltage V_o = 3.308 V

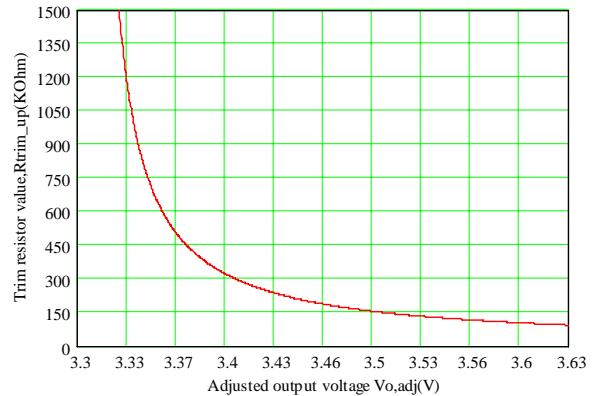
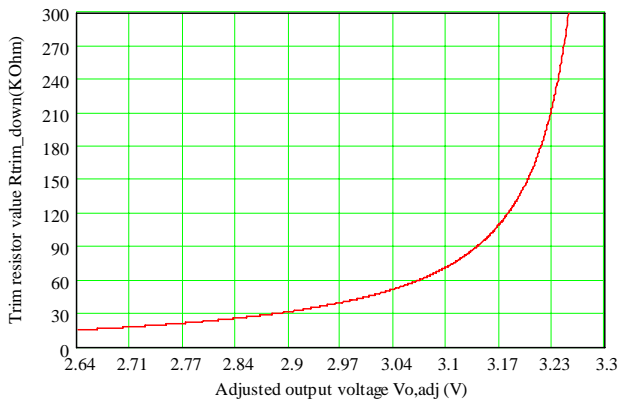
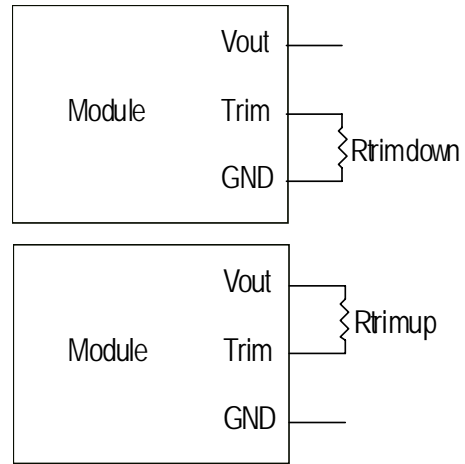

Remote Sense

This module has remote sense compensation feature. It can minimize the effects of resistance between module's output and load in system layout and facilitates accurate voltage regulation at load terminals or other selected point.

1. The remote sense lines carries very little current and hence do not require a large cross-sectional area.
2. This module compensates for a maximum drop of 10% of the nominal output voltage.
3. If the unit is already trimmed up, the available remote sense compensation range should be correspondingly reduced. The total voltage increased by trim and remote sense should not exceed 10% of the nominal output voltage.
4. When using remote sense compensation, all the resistance, parasitic inductance and capacitance of the system are incorporated within the feedback loop of this module. It can make an effect on the module's compensation, affecting the stability and dynamic response. A 0.1uF ceramic capacitor can be connected at the point of load to de-couple noise on the sense wires.
5. Recommend the connection of remote sense compensation as below figure. There are a resistor RS+ (100 ohm) from Vo+ to Sense+ and a resistor RS- (51 ohm) from Vo- to Sense- inside of this module.

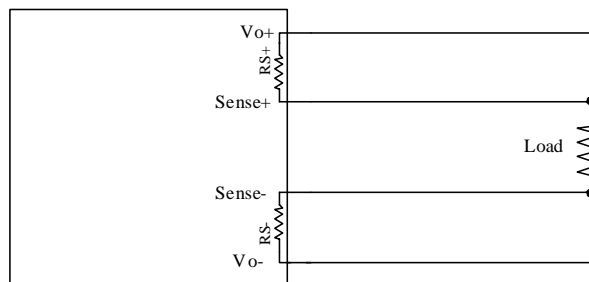

6. If not using remote sense compensation, please connect sense directly to output at module's pin, that is, connect sense+ to Vo+ and sense- to Vo- at module's pin, the shorter the better. See below figure.

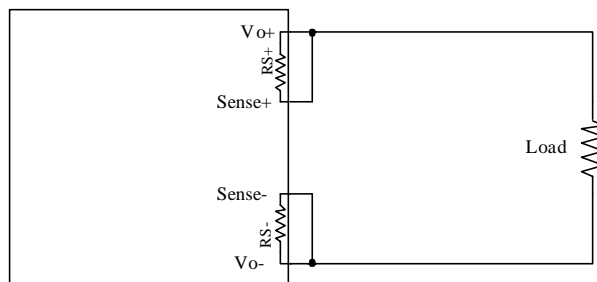

ISOLATED DC/DC CONVERTERS
 36 Vdc - 75 Vdc Input, 3.3 Vdc/15 A Output



Jul. 09, 2010

Bel Power Inc., a subsidiary of Bel Fuse Inc.

Startup & Shutdown

Rise time

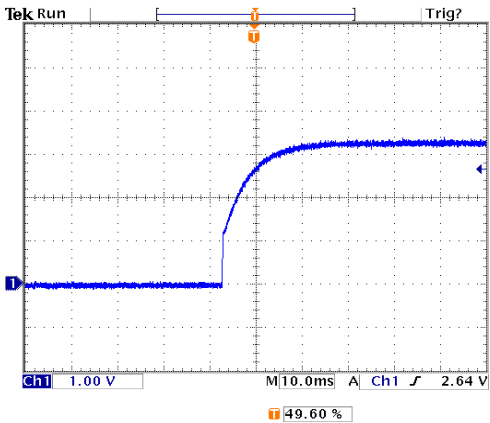

Ch1 Rise
9.517ms

Test Condition:
48Vin, 3.3V/15A

18 Mar 2010
15:54:22

Startup time

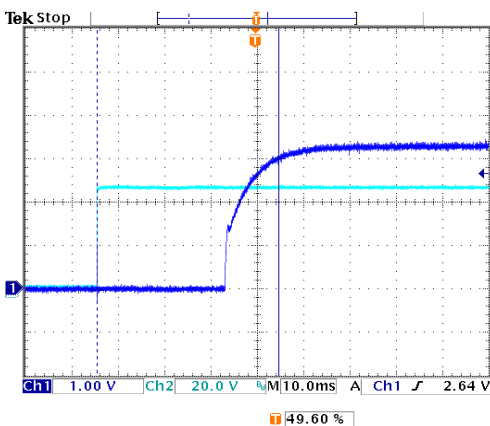

Δ: 3.04 V
@: 2.98 V
Δ: 39.2ms
@: 5.00ms

18 Mar 2010
15:48:48

Startup from Vin
Ch1: Vo, Ch2: Vin
Test Condition: 48Vin, 3.3V/15A

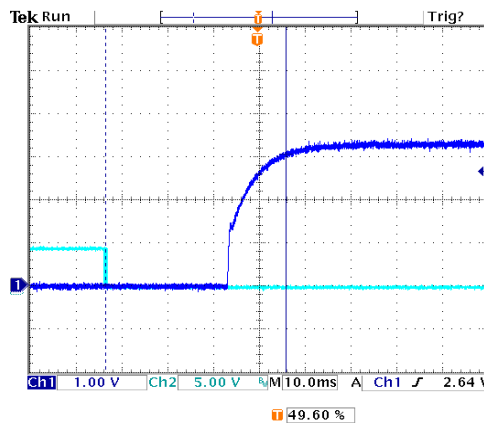

Δ: 3.04 V
@: 3.04 V
Δ: 39.4ms
@: 6.20ms

18 Mar 2010
15:52:28

Startup from on/off
Startup from on/off, Ch2: Vin
Test Condition: 48Vin, 3.3V/15A

Shutdown

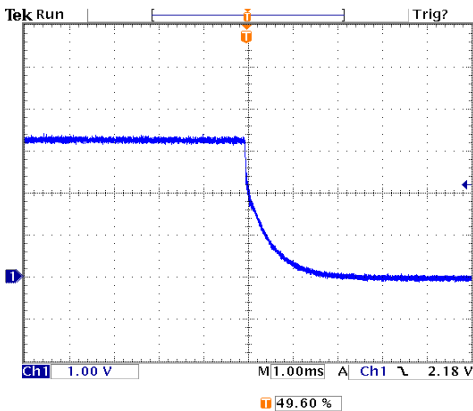

Ch1 Fall
1.021ms

Test Condition:
48Vin, 3.3V/15A

18 Mar 2010
15:56:05

Over Current Protection

To provide protection in a fault output overload condition, the module is equipped with internal current-limiting circuitry and can endure current limiting for a few milli-seconds. If the overcurrent condition persists beyond a few milliseconds, the module will shut down into hiccup mode and restart once every 300mS. The module operates normally when the output current goes into specified range. The typical average output current is 0.8A during hiccup.

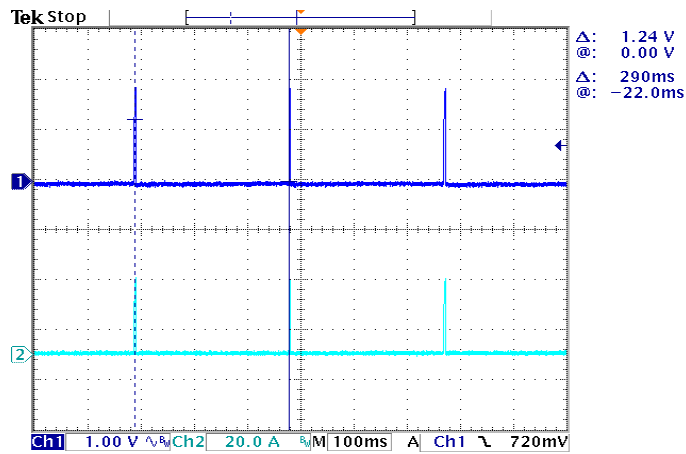

18 Mar 2010
16:18:37

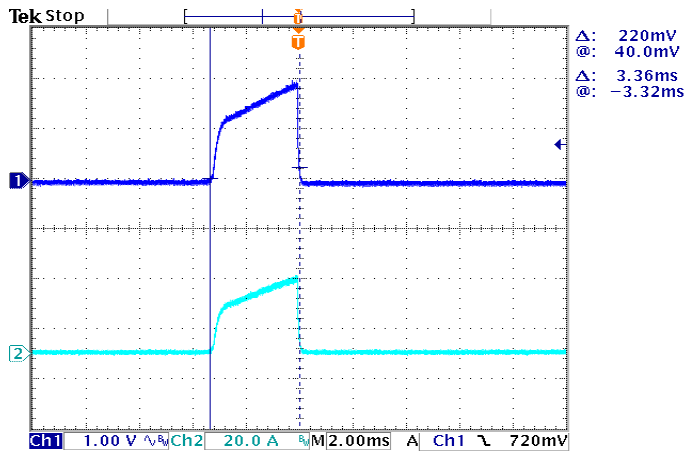

18 Mar 2010
16:17:43

Expansion of on time portion of above figure

ISOLATED DC/DC CONVERTERS

36 Vdc - 75 Vdc Input, 3.3 Vdc/15 A Output



Jul. 09, 2010

Bel Power Inc., a subsidiary of Bel Fuse Inc.

Over Voltage Protection

The output overvoltage protection consists of circuitry that monitors the voltage on the output terminals. If the voltage on the output terminals exceeds the over voltage protection threshold, the module will shutdown into hiccup mode and restart once every 400mS. The module operates normally when the fault is cleared.

Test setup:

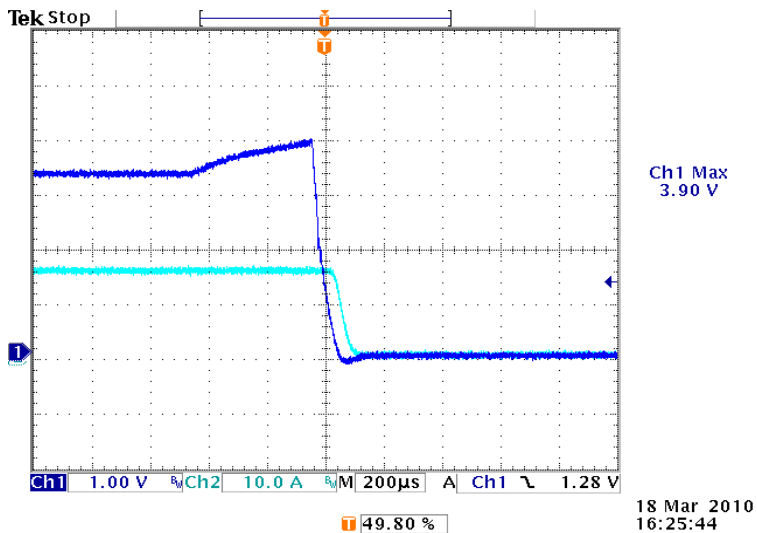
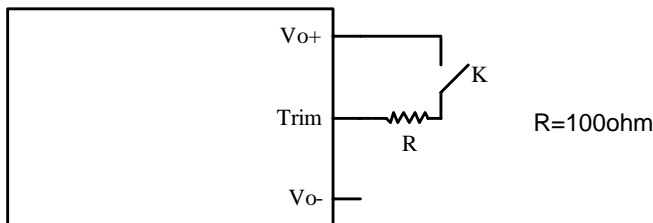

CH1: Output voltage waveform
CH2: Output Current waveform

ISOLATED DC/DC CONVERTERS

36 Vdc - 75 Vdc Input, 3.3 Vdc/15 A Output



Jul. 09, 2010

Bel Power Inc., a subsidiary of Bel Fuse Inc.

Over Temperature Protection

The OTP is achieved by thermistor U1 and the threshold is set at 120C in non-latch mode; the hottest component Q5 reaches 130C with 100LFM air flow correspondingly. It will restart automatically when the temperature falls down to 100C. The protecting point will be varied a little under different conditions (air flow, ambient temperature, input voltage, load...).

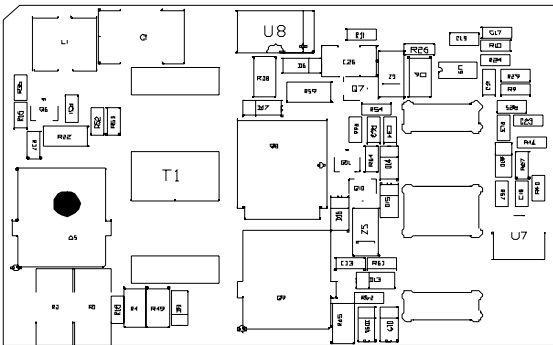

the hottest component Q5 on top view

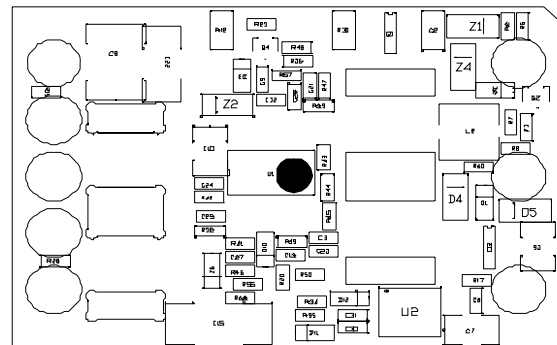

thermistor U1 on bottom view

Under Voltage Lockout

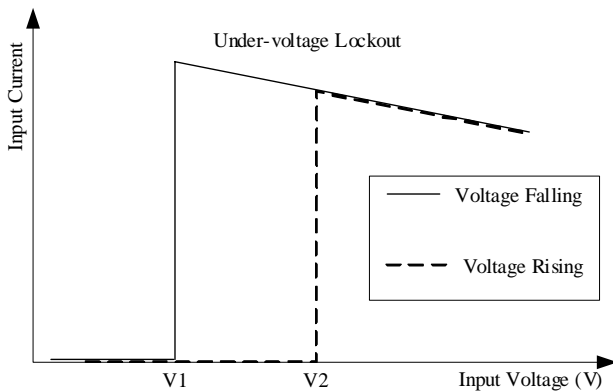

V1=31V
V2=32V

ISOLATED DC/DC CONVERTERS
36 Vdc - 75 Vdc Input, 3.3 Vdc/15 A Output



Jul. 09, 2010

Bel Power Inc., a subsidiary of Bel Fuse Inc.

Mechanical Outline

ORSB-50T03C

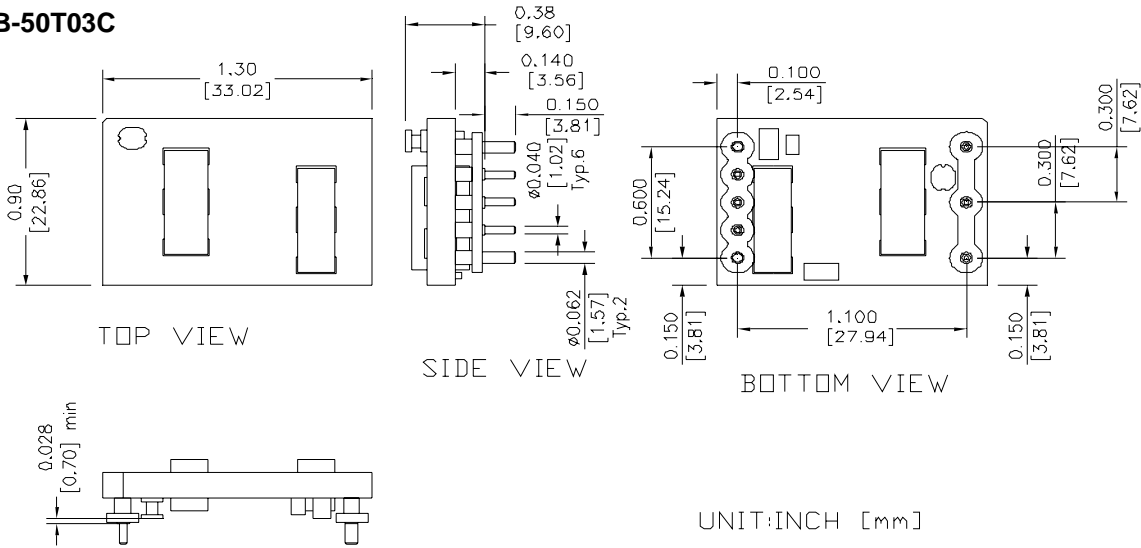

UNIT:INCH [mm]

RECOMMENDED PCB PAD LAYOUT

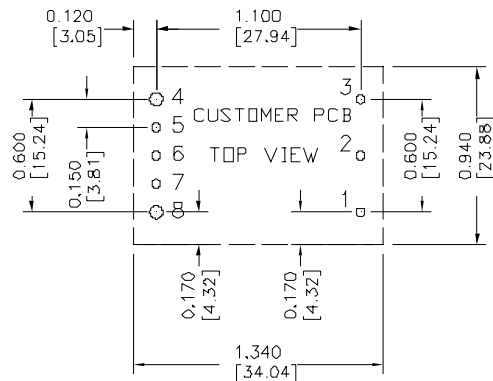

HOLE SIZE: 1-3, 5-7 ϕ 0.047[1.19],
4,8 ϕ 0.07 [1.78]
PAD SIZE: 1-3, 5-7 ϕ 0.08[2.03]
4,8 ϕ 0.10 [2.54]

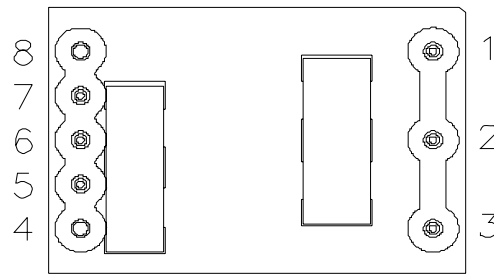

BOTTOM VIEW

Pin Connections

pin#	function	pin#	function
1	Vin (+)	5	RS (-)
2	On/Off	6	Trim
3	Vin (-)	7	RS (+)
4	Vo (-)	8	Vo (+)

Note: This module is recommended and compatible with Pb-Free Wave Soldering and must be soldered using a peak solder temperature of no more than 260 °C for less than 5 seconds.

Note:

- 1) All Pins: Material - Copper Alloy;
Finish – 3 micro inches minimum Gold over 50 micro inches minimum Nickel plate.
- 2) Undimensioned components are shown for visual reference only.
- 3) All dimensions in inches (mm); Tolerances: x.xx +/-0.02 in. (x.x +/-0.5mm) x.xxx +/-0.010 in. (x.xx +/-0.25mm).

ISOLATED DC/DC CONVERTERS
36 Vdc - 75 Vdc Input, 3.3 Vdc/15 A Output



Jul. 09, 2010

Bel Power Inc., a subsidiary of Bel Fuse Inc.

Mechanical Outline (continued)

SRSB-50T03C

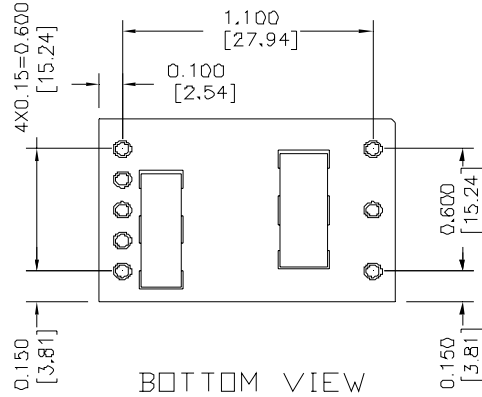
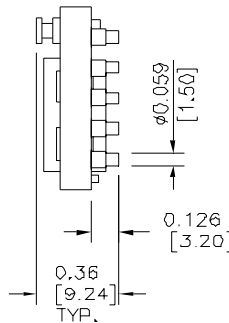
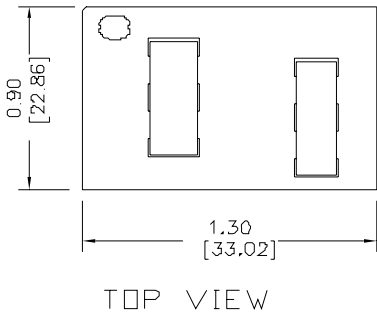

UNIT: INCH [mm]

RECOMMENDED PCB PAD LAYOUT

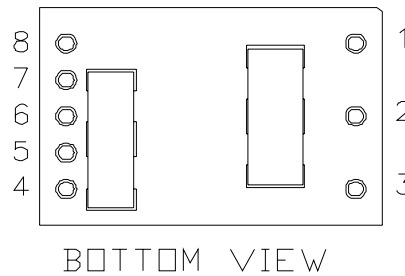
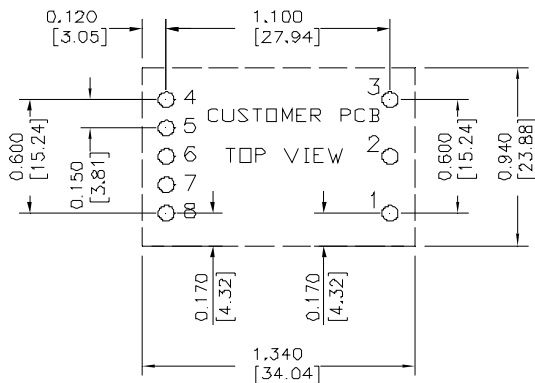

Pin Connections

pin#	function	pin#	function
1	Vin (+)	5	RS (-)
2	On/Off	6	Trim
3	Vin (-)	7	RS (+)
4	Vo (-)	8	Vo (+)

Recommended Surface Mount Pads
Min. ϕ 0.080" [2.03]
Max. ϕ 0.092" [2.34]

Note: This module is recommended and compatible with Pb-Free Reflow Soldering and must be soldered using a reflow profile with a peak temperature of no more than 260°C for less than 5 seconds.

Note:

- 1) All Pins: Material - Copper Alloy;
Finish – 3 micro inches minimum Gold over 50 micro inches minimum Nickel plate.
- 2) Undimensioned components are shown for visual reference only.
- 3) All dimensions in inches (mm); Tolerances: x.xx +/-0.02 in. (x.x +/-0.5mm) x.xxx +/-0.010 in. (x.xx +/-0.25mm).

ISOLATED DC/DC CONVERTERS
36 Vdc - 75 Vdc Input, 3.3 Vdc/15 A Output



Jul. 09, 2010

Bel Power Inc., a subsidiary of Bel Fuse Inc.

Revision History

Date	Version	Changes Detail	Approval
2010-3-23	A	First release	Jack Fan
2010-7-9	B	Update the Outline drawing of 0RSB-50T03C	JZ Wang

RoHS Compliance

Complies with the European Directive 2002/95/EC, calling for the elimination of lead and other hazardous substances from electronic products.



©2010 Bel Fuse Inc. Specifications subject to change without notice. 070910

CORPORATE

Bel Fuse Inc.
206 Van Vorst Street
Jersey City, NJ 07302
Tel 201-432-0463
Fax 201-432-9542
www.belfuse.com

FAR EAST

Bel Fuse Ltd.
8F/ 8 Luk Hop Street
San Po Kong
Kowloon, Hong Kong
Tel 852-2328-5515
Fax 852-2352-3706
www.belfuse.com

EUROPE

Bel Fuse Europe Ltd.
Preston Technology Management Centre
Marsh Lane, Suite G7, Preston
Lancashire, PR1 8UD, U.K.
Tel 44-1772-556601
Fax 44-1772-888366
www.belfuse.com