

SR502-G Thru. SR510-G

Forward current: 5.0A
Reverse voltage: 20 to 100V
RoHS Device

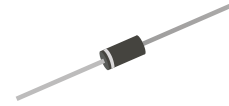

Features

- Fast switching.
- Low forward voltage, high current capability.
- Low power loss, high efficiency.
- High current surge capability.
- High temperature soldering guaranteed: 250°C/10 seconds, 0.375" (9.5mm) lead length at 5lbs (2.3kg) tension.

Mechanical Data

- Epoxy: UL94V-0 rate flame retardant.
- Case: transfer molded plastic.
- Lead: plastic axial lead, solderable per MIL-STD-202E, method 208C.
- Polarity: color band denoted cathode end.
- Mounting position: any.
- Weight: 1.27 gram.

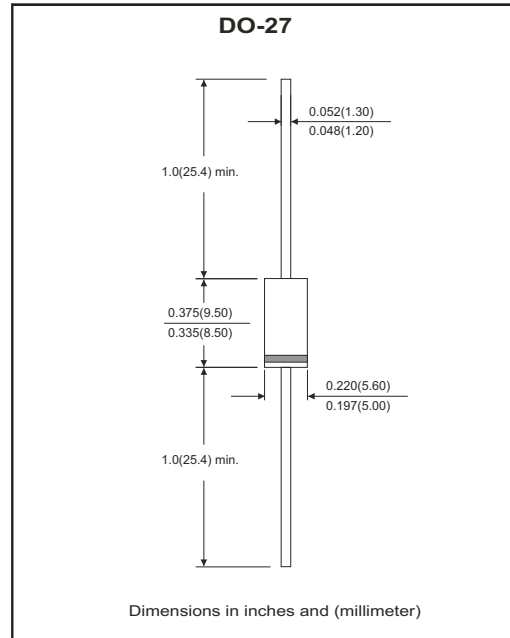

Maximum Ratings and Electrical Characteristics

Rating At 25°C ambient temperature unless otherwise specified
 Single phase, half wave, 60Hz, resistive or inductive loaded.
 For capacitive load, derate current by 20% .

Parameter	Symbol	SR502 -G	SR503 -G	SR504 -G	SR505 -G	SR506 -G	SR508 -G	SR510 -G	Unit
Maximum repetitive peak reverse voltage	V _{RRM}	20	30	40	50	60	80	100	V
Maximum RMS voltage	V _{RMS}	14	21	28	35	42	57	70	V
Maximum DC blocking voltage	V _{DC}	20	30	40	50	60	80	100	V
Maximum average forward rectified current, 0.375" (9.5mm) lead length (Note 1) See Fig.1	I _(AV)	5.0							A
Peak forward surge current, 8.3ms single half sine-wave, superimposed on rated load (JEDEC method)	I _{FSM}	150							A
Maximum instantaneous forward voltage at I _F =5.0A	V _F	0.55			0.75		0.85		V
Maximum DC reverse current at rated DC blocking voltage per element (Note 1)	TA=25°C	1.0							mA
	TA=100°C	50							
Typical junction capacitance (Measured at 1.0Hz and applied reverse voltage of 4.0V)	C _J	550			450		350		pF
Typical thermal resistance	R _{θJA}	15							°C/W
Operating junction temperature range	T _J	-55 ~ +150							°C
Storage temperature range	T _{STG}	-55 ~ +150							°C

Note:

1. Pulse pulse: 300µS pulse width, 1% duty cycle.

RATING AND CHARACTERISTIC CURVES (SR502-G Thru. SR510-G)

Fig.1- Typical Forward Current Derating Curve

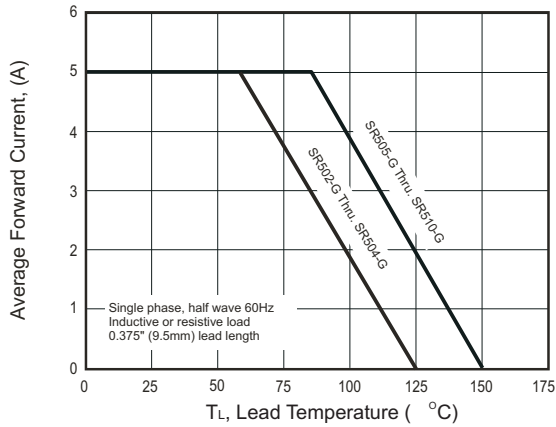

Fig.2- Maximum Non-Repetitive Peak Forward Surge Current

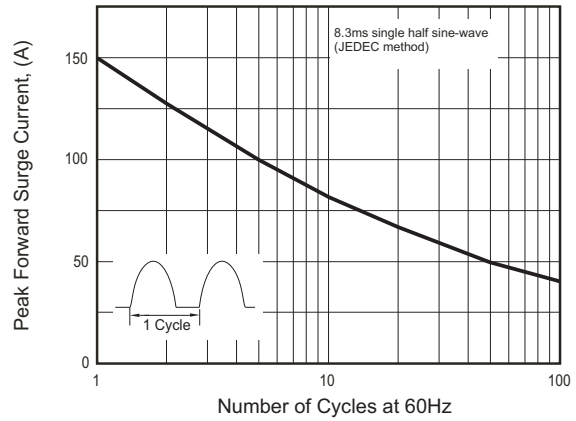

Fig.3- Typical Instantaneous Forward Characteristics

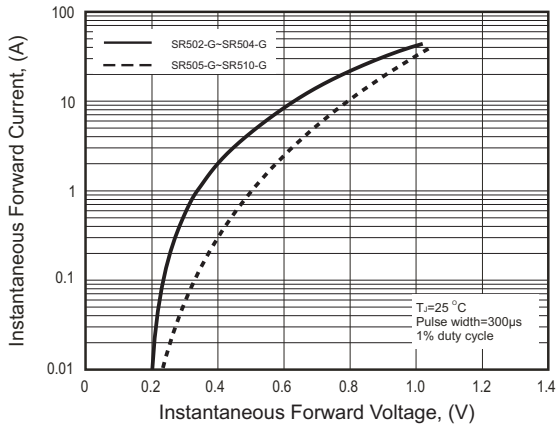

Fig.4- Typical Reverse Characteristics

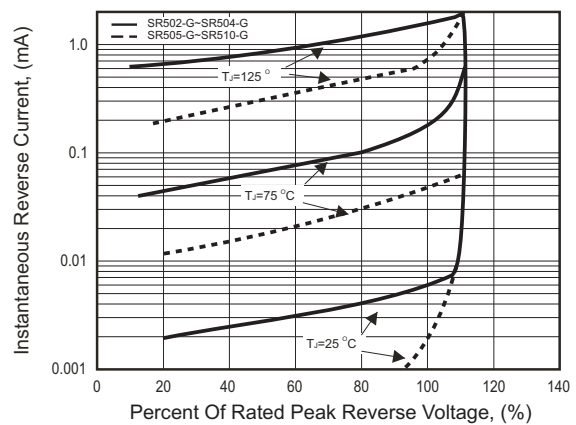
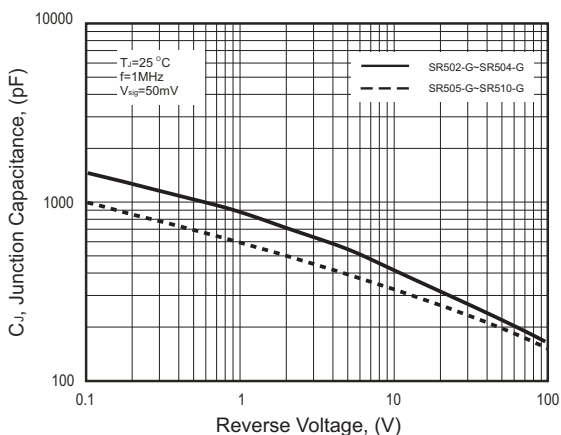
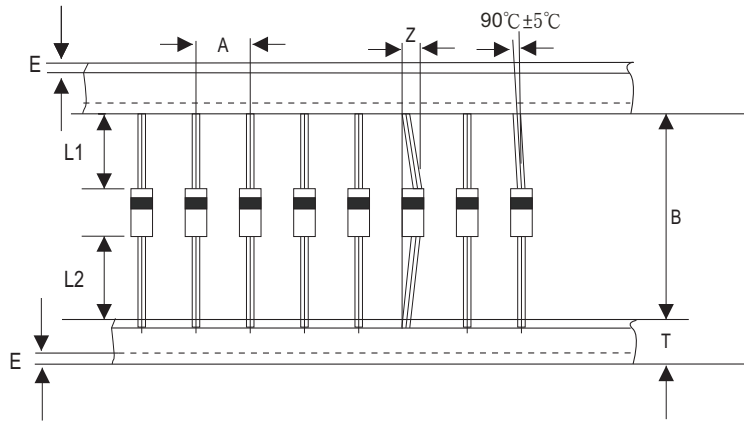

Fig.5- Typical Junction Capacitance



Ammo Box Packaging Specification For Axial- Lead Rectifiers



DO-27	SYMBOL	A	B	Z	T	E	L1-L2
	(mm)	10.0 ± 0.5	52.4 +1.5 /-0.4	1.2 (max)	6.0 ± 0.4	0.8 (max)	1.0 (max)
	(inch)	0.394 ± 0.020	2.063 ^{+0.059} /-0.016	0.047 (max)	0.236 ± 0.016	0.031(max)	0.039 (max)

DO-27	SYMBOL	Box Length	Box Width	Box Height
	(mm)	245.0 ± 5.0	75.0 ± 5.0	90.0 ± 5.0
	(inch)	9.65 ± 0.197	2.95 ± 0.197	3.54 ± 0.197

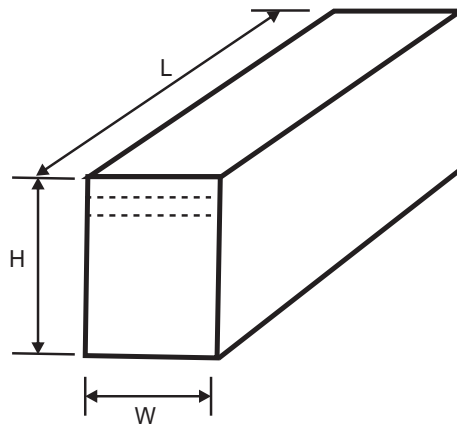

Standard Package

Case Type	AMMO BOX		
	Inner Box (PCS)	Box / Carton	CARTON (PCS)
DO-27	500	18	9,000