



Axial Lead Diode

Rectifier Diode

SK 1

Features

- Reverse voltages up to 1600 V
- Taped for automatic insertion
- Available with formed leads on request
- Plastic material used carries Underwriter Laboratories flammability classification 94V-0

Typical Applications*

- All-purpose rectifier diodes

V_{RSM} V	V_{RRM} V	$I_{FRMS} = 3\text{ A}$ (maximum value for continuous operation) $I_{FAV} = 1\text{ A}$ (sin. 180; $T_a = 60\text{ °C}$)	
1000	1000	SK 1/10	
1200	1200	SK 1/12	
1400	1400	SK 1/14	
1600	1600	SK 1/16	

Symbol	Conditions	Values	Units
I_{FAV}	sin. 180; L = 10 mm; $T_r = 85\text{ (100) °C}$	1,45 (1,2)	A
I_{FSM}	$T_{vj} = 25\text{ °C}$; 10 ms	60	A
	$T_{vj} = 150\text{ °C}$; 10 ms	50	A
i^2t	$T_{vj} = 25\text{ °C}$; 8,3 ... 10 ms	18	A ² s
	$T_{vj} = 150\text{ °C}$; 8,3 ... 10 ms	12,5	A ² s
V_F	$T_{vj} = 25\text{ °C}$; $I_F = 10\text{ A}$	max. 1,5	V
$V_{(TO)}$	$T_{vj} = 150\text{ °C}$	max. 0,85	V
r_T	$T_{vj} = 150\text{ °C}$	max. 75	mΩ
I_{RD}	$T_{vj} = 150\text{ °C}$; $V_{RD} = V_{RRM}$	max. 0,4	mA
Q_{rr}	$T_{vj} = 150\text{ °C}$; $-di_F/dt = 10\text{ A/μs}$; $I_F = 10\text{ A}$	10	μC
$R_{th(j-r)}$	L = 10 mm	40	K/W
$R_{th(j-a)}$	PCB 50 x 50 mm	85	K/W
T_{vj}		- 40 ... + 150	°C
T_{stg}		- 40 ... + 150	°C
T_{sold}	max. 10 s; L > 9mm	250	°C
V_{isol}		-	V~
a		5 * 9,81	m/s ²
m	approx.	0,5	g
Case	3500 diodes per reel	E 33	

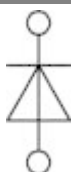

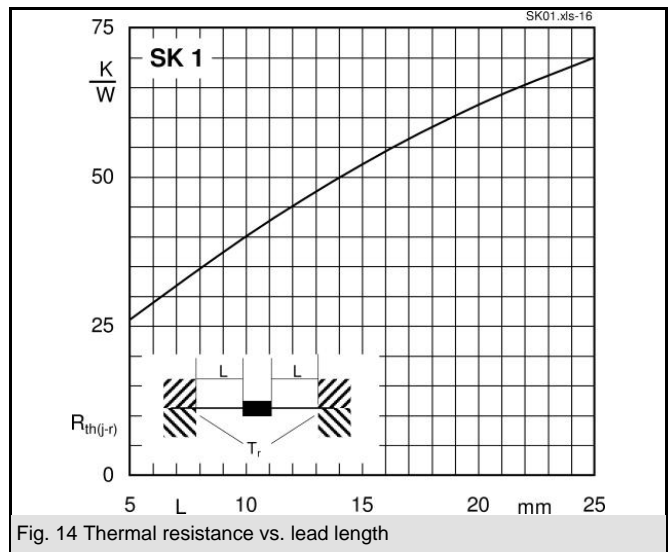
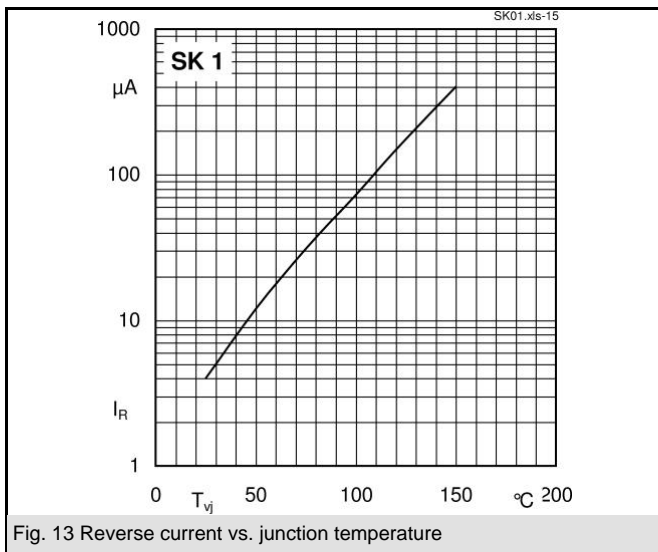
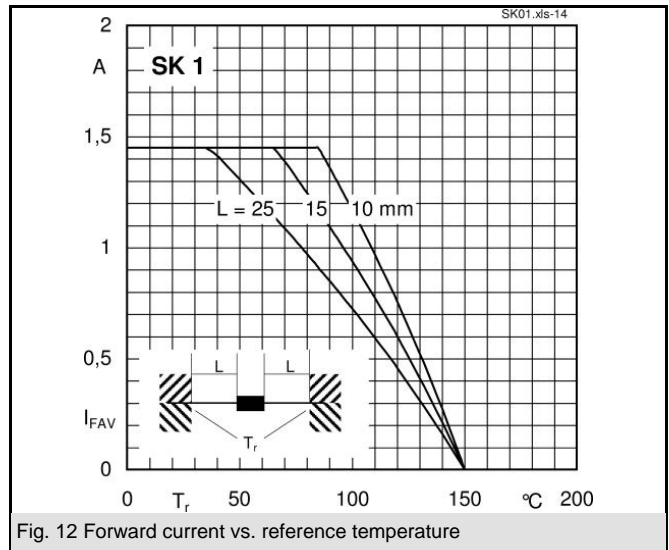
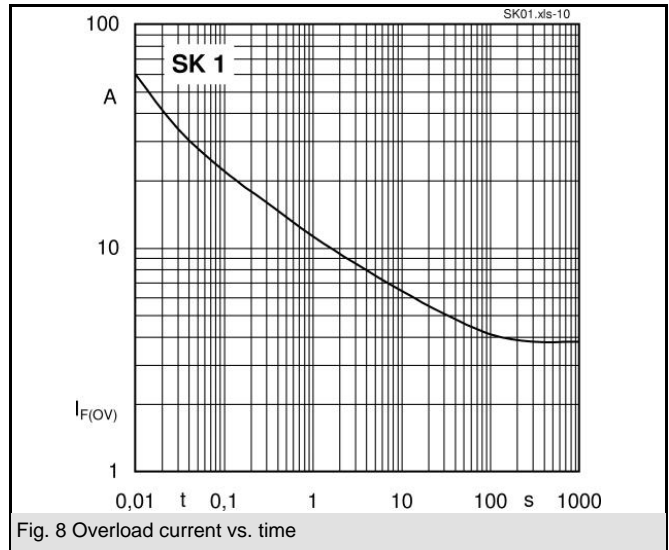
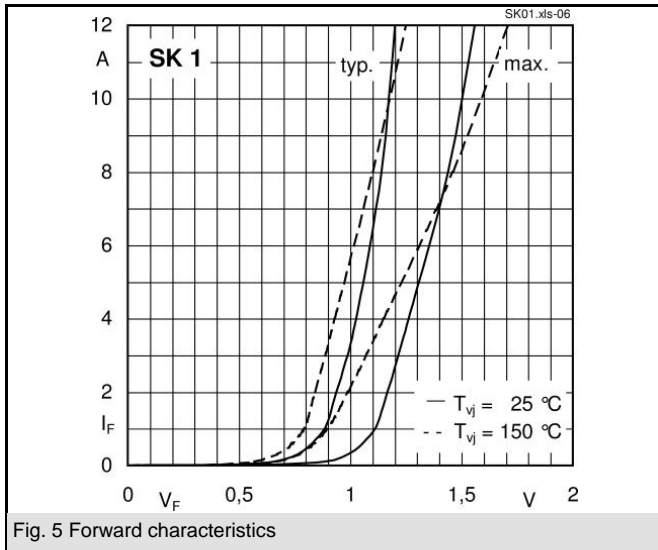

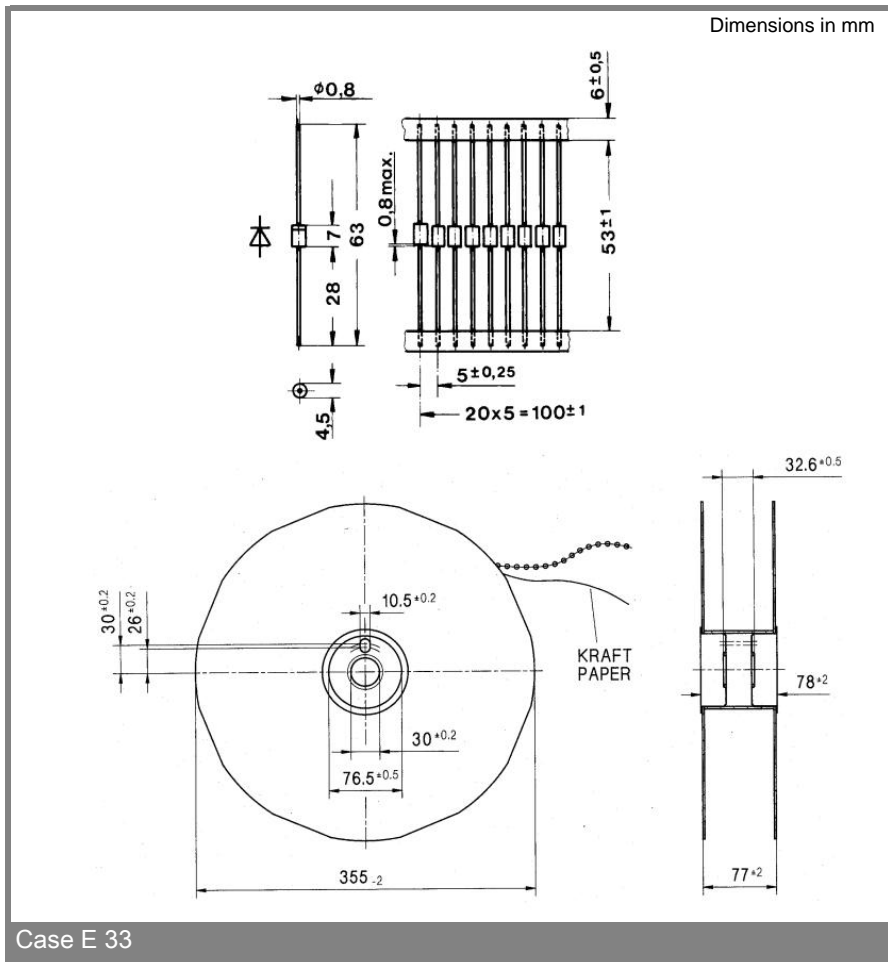

* The specifications of our components may not be considered as an assurance of component characteristics. Components have to be tested for the respective application. Adjustments may be necessary. The use of SEMIKRON products in life support appliances and systems is subject to prior specification and written approval by SEMIKRON. We therefore strongly recommend prior consultation of our personal.