



Features

- Small size
- SMT-compatible
- Easily formed leads
- Sputtered ruthenium contacts
- Hermetically sealed contacts
- Fast switching speed — up to 500Hz
- Wide range of available magnetic sensitivities

Applications

- Security
 - Proximity sensing
 - Smoke alarms
- Automotive
 - Level sensor
 - Lamp current sensor
- Relays

Approvals

- UL listed

Standard Test Coil

The magnetic force (expressed in NI, AT or Ampere Turns) required to cause the reed switch contacts to close is called the pull-in or operate value.

	FR2
Part #	Coil - 1
Coil definition	NARM1 CTC01
Coil resistance	1200Ω
Number of turns	5,000
Wire size (nom. diameter)	0.0399mm (AWG 46)
Bobbin diameter (inside coil)	3.96mm
Winding length	10.4mm

⁽¹⁾ Consult factory for test procedure.

The reed switch shall be placed in the test coil with the gap centered in the core of the coil winding. Test leads and their clips must be non-magnetic.

The longitudinal axis of the test coil and the test switch shall be vertical.

Description

Clare's DYAD® dry reed switches are ideally suited for small switching signal applications. This switch has sputtered ruthenium contacts and an extraordinary seal strength, achieved by a patented laser sealing of the glass. In low level or dry switching environments, both switches typically provide >1 billion operations. The switches have hermetically sealed contacts and offer a wide range of available magnetic sensitivities.

Ordering Information

A complete part number is represented by the digits to the right. For example, FR2S1030 is a DYAD® with a minimum operate value of 10 and a maximum of 30. Refer to the switch operating specification charts for available ranges. Special ranges are available upon request.

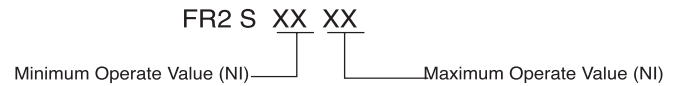

Surface Mount Dyad

Refer to operating characteristics table for complete part number.

DYAD®

Part #	Operate Range (NI) ¹
FR2S1015	10 to 15
FR2S1020	10 to 20
FR2S1030	10 to 30
FR2S1520	15 to 20
FR2S1525	15 to 25
FR2S2025	20 to 25

DYAD® Surface Mount

Part #	Operate Range (NI) ^{1,2,3}
FR2024	10 to 15
FR2259	10 to 20
FR2282	10 to 30
FR2025	15 to 20
FR2249	15 to 25
FR2026	20 to 25

¹ Tolerance = ± 1.5NI

² Full Blade Sensitivity

³ Surface Mount Switches are packaged 3,000 parts per reel

FR2

Ratings (@ 25° C)

Parameter	Min	Typ	Max	Units
Switching Voltage FR2 - DYAD®			200	Volts
Switching Current FR2 - DYAD®			0.5	Amps
Carry Current FR2 - DYAD®			1.5	Amps
Switching Frequency FR2 - DYAD®			500	Hz
Contact Resistance FR2 - DYAD®			150	mΩ

(See detailed specifications for more information.)

Absolute Maximum Ratings are stress ratings. Stresses in excess of these ratings can cause permanent damage to the device. Functional operation of the device at these or any other conditions beyond those indicated in the operational sections of this data sheet is not implied. Exposure of the device to the absolute maximum ratings for extended period may degrade the device and effect its reliability.

Specifications

All parameters are at 25°C unless otherwise stated.

PARAMETER	CONDITIONS	SYMBOL	MIN	TYP	MAX	UNITS
Contact Ratings						
Operate ampere turns range	Full Blade Tolerance = ± 1.5NI	AT	10	-	30	NI
Release ampere turns range	Full Blade Tolerance = ± 1.5NI	AT	5	-	30	NI
Switching Voltage	Max DC/PeakAC Resistive	V _L	-	-	200	VDC
Switching Current	Max DC/PeakAC Resistive	I _L	-	-	500	mAmps
Carry Current	Max DC/PeakAC Resistive	I _C	-	-	1.5	Amps
Contact Rating	Max DC/PeakAC Resistive	-	-	-	10	VA
Life Expectancy	1V, 10mA Signal Level	-	-	1000	-	x10 ⁶ Ops
	10V, 10mA Low Level	-	-	500	-	x10 ⁶ Ops
	50V, 100mA Telecom Load	-	-	2	-	x10 ⁶ Ops
	100V, 100mA Rated Loads	-	-	2	-	x10 ⁶ Ops
Static Contact Resistance	50mV, 10mA ⁽¹⁾	CR	-	80	150	mΩ
Contact Material		-	-	Ru	-	-
Switch Specifications						
Insulation Resistance ⁽²⁾	100V, 25°C, 40% RH	IR	10 ⁹	10 ¹¹	-	Ω
Capacitance	Across Open Contacts	-	-	0.3	-	pF
Dielectric Strength ⁽⁵⁾	Between Contacts	-	250	300	-	VDC/Peak AC
Operate Time, including bounce	At nominal coil voltage, 10Hz Square Wave	T _{OP}	-	-	0.5	ms
Release Time	Zener-Diode Suppression ⁽³⁾	T _{REL}	-	-	0.2	ms
Environmental Ratings						
Storage Temperature		T _A	-40	-	+125	°C
Operating Temperature		T _O	-40	-	+125	°C
Soldering Temperature		-	-	-	+240	°C
Vibration Resistance	5Hz - 200Hz	G	-	-	20	Gs
Shock Resistance	11±1ms, 1/2 Sine Wave	S	-	-	100	Gs
Weight		-	-	0.13	-	grams/unit

⁽¹⁾ Contact resistance measured with 4 terminal method, 1.1" between test leads

⁽²⁾ >10¹² Ω is available upon request

⁽³⁾ A 24V zener in series with a diode across the coil

⁽⁴⁾ Use caution not to exceed vibration resistance limits while ultrasonically cleaning. Contact Clare Engineering for more details/recommendations

⁽⁵⁾ 15 ampere turn minimum

Performance Data*

DYAD®

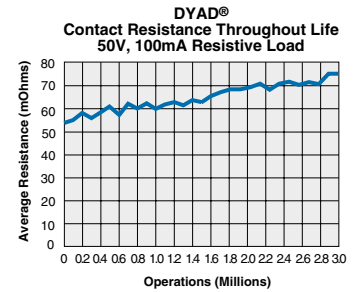
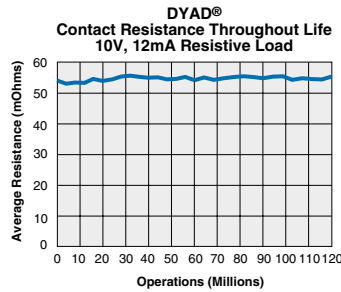
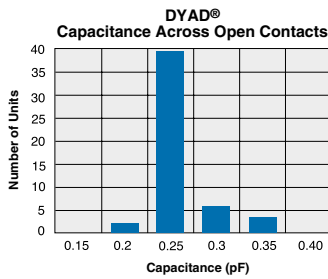
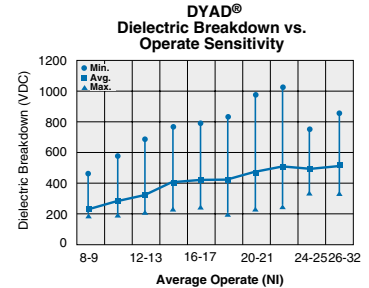
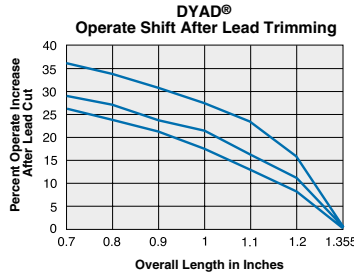
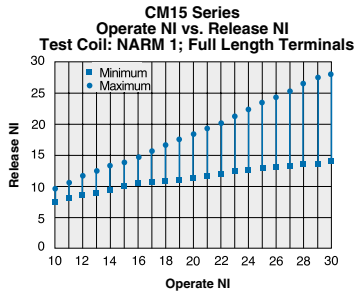

*The Performance data shown in the graphs above is typical of device performance. For guaranteed parameters not indicated in the written specifications, please contact our application department.

Mechanical Dimensions

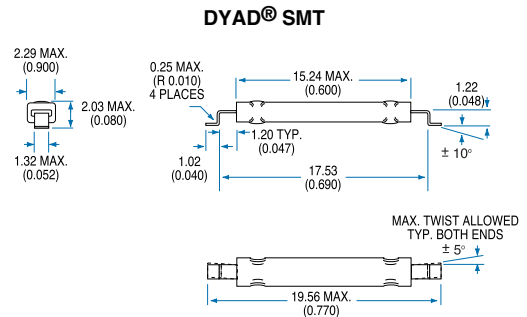
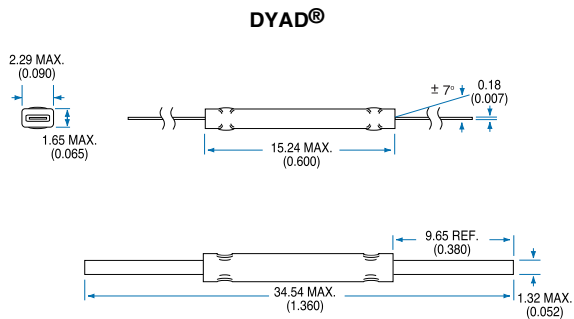

Recommended Pad Sizes

DYAD® SMT

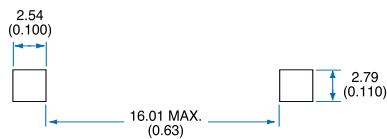

DIMENSIONS
mm
(inches)

Tape & Reel Packaging

Tape and Reel Packaging for DYAD®-Gull Wing Terminals

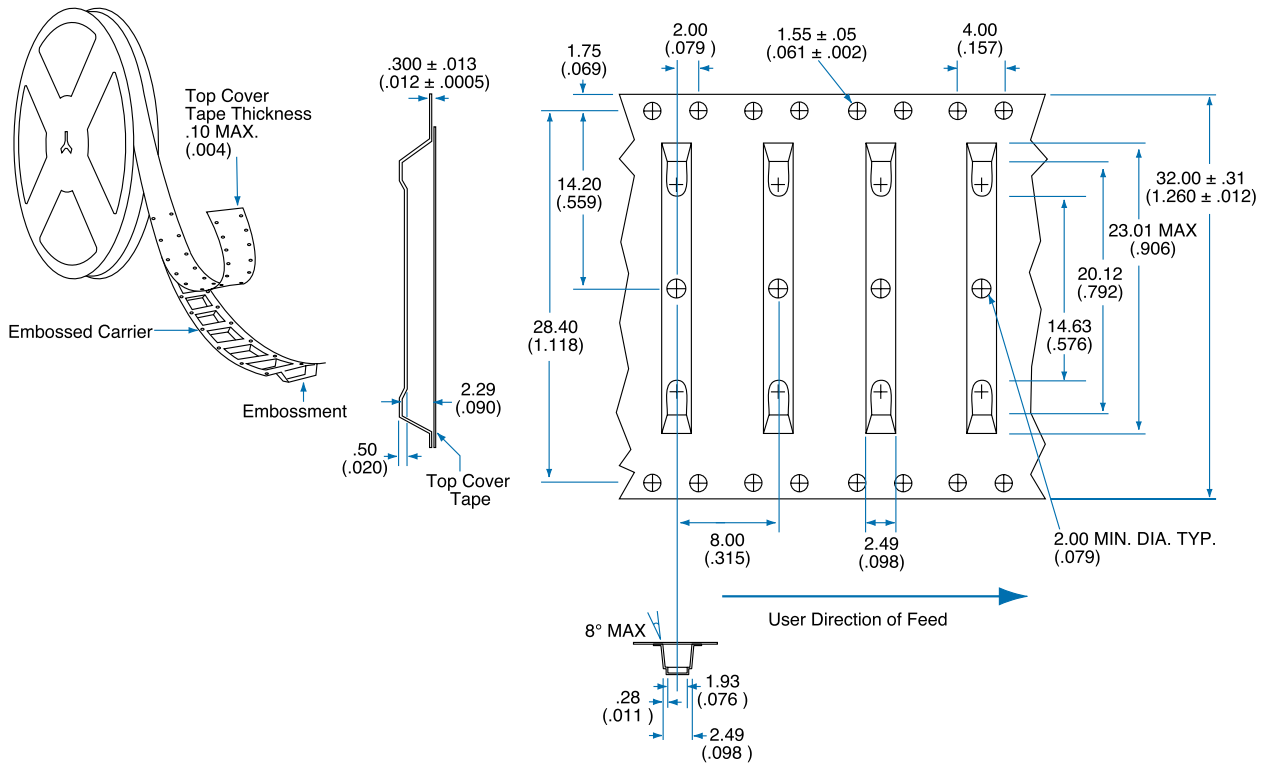

DIMENSIONS
mm
(inches)

CLARE LOCATIONS

Clare Headquarters
78 Cherry Hill Drive
Beverly, MA 01915
Tel: 1-978-524-6700
Fax: 1-978-524-4900
Toll Free: 1-800-27-CLARE

Clare Switch Division
4315 Earth City Expressway
St. Louis, MO 63045
Tel: 1-314-770-1832
Fax: 1-314-770-1812

Clare Micronix Division
145 Columbia
Aliso Viejo, CA 92656-1490
Tel: 1-949-831-4622
Fax: 1-949-831-4628

SALES OFFICES

AMERICAS

Americas Headquarters

Clare
78 Cherry Hill Drive
Beverly, MA 01915
Tel: 1-978-524-6700
Fax: 1-978-524-4900
Toll Free: 1-800-27-CLARE

Eastern Region

Clare
P.O. Box 856
Mahwah, NJ 07430
Tel: 1-201-236-0101
Fax: 1-201-236-8685
Toll Free: 1-800-27-CLARE

Central Region

Clare Canada Ltd.
3425 Harvester Road, Suite 202
Burlington, Ontario L7N 3N1
Tel: 1-905-333-9066
Fax: 1-905-333-1824

Western Region

Clare
1852 West 11th Street, #348
Tracy, CA 95376
Tel: 1-209-832-4367
Fax: 1-209-832-4732
Toll Free: 1-800-27-CLARE

Canada

Clare Canada Ltd.
3425 Harvester Road, Suite 202
Burlington, Ontario L7N 3N1
Tel: 1-905-333-9066
Fax: 1-905-333-1824

EUROPE

European Headquarters

CP Clare nv
Bampslaan 17
B-3500 Hasselt (Belgium)
Tel: 32-11-300868
Fax: 32-11-300890

France

Clare France Sales
Lead Rep
99 route de Versailles
91160 Champlan
France
Tel: 33 1 69 79 93 50
Fax: 33 1 69 79 93 59

Germany

Clare Germany Sales
ActiveComp Electronic GmbH
Mitterstrasse 12
85077 Manching
Germany
Tel: 49 8459 3214 10
Fax: 49 8459 3214 29

Italy

C.L.A.R.E.s.a.s.
Via C. Colombo 10/A
I-20066 Melzo (Milano)
Tel: 39-02-95737160
Fax: 39-02-95738829

Sweden

Clare Sales
Comptronic AB
Box 167
S-16329 Spånga
Tel: 46-862-10370
Fax: 46-862-10371

United Kingdom

Clare UK Sales
Marco Polo House
Cook Way
Bindon Road
Taunton
UK-Somerset TA2 6BG
Tel: 44-1-823 352541
Fax: 44-1-823 352797

ASIA PACIFIC

Asian Headquarters

Clare
Room N1016, Chia-Hsin, Bldg II,
10F, No. 96, Sec. 2
Chung Shan North Road
Taipei, Taiwan R.O.C.
Tel: 886-2-2523-6368
Fax: 886-2-2523-6369

<http://www.clare.com>

Clare cannot assume responsibility for use of any circuitry other than circuitry entirely embodied in this Clare product. No circuit patent licenses nor indemnity are expressed or implied. Clare reserves the right to change the specification and circuitry, without notice at any time. The products described in this document are not intended for use in medical implantation or other direct life support applications where malfunction may result in direct physical harm, injury or death to a person.

Specification: PB-FR2-R2
©Copyright 2000
Ultra-Mini Dyad™, Mini Dyad™, and Dyad® are trademarks of Clare, Inc.
All rights reserved. Printed in USA.
3/7/01