



HIGH EFFICIENCY GLASS PASSIVATED RECTIFIER

HER1601C THRU HER1607C

VOLTAGE RANGE

50 to 1000 Volts

CURRENT

16.0 Ampere

FEATURES

- High speed switching
- Glass passivated chip junction
- Low power loss, high efficiency
- Low leakage
- High surge capacity
- High temperature soldering guaranteed
250°C/10 second, 0.16" (4.06mm) lead length
- Also available with common Anode, add an "A" suffix,
i.e. HER1601CA, and as a doubler, add a "D" suffix,
i.e. HER1601CD
- Also available in an isolated package, HERF1601C
- Also available in the single chip version, HER1601

MECHANICAL DATA

- Case: Transfer molded plastic
- Epoxy: UL94V-0 rate flame retardant
- Lead: Solderable per MIL-STD-202E method 208C
- Polarity: as Marked
- Mounting position: Any, 5 in-lbs Torque Max
- Weight: 0.08 ounce, 2.24 gram

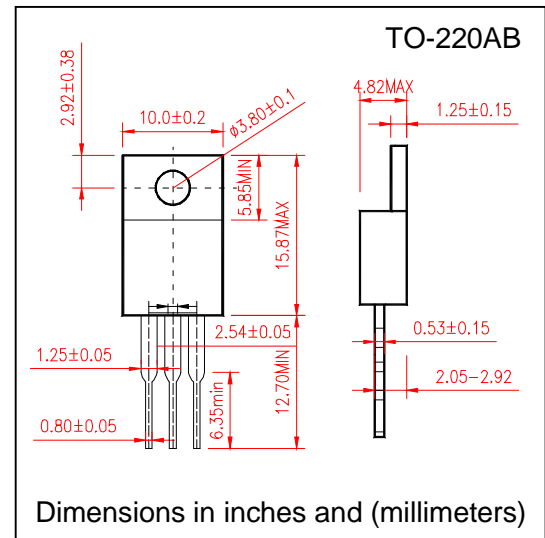

MAXIMUM RATINGS AND ELECTRICAL CHARACTERISTICS

- Ratings at 25°C ambient temperature unless otherwise specified
- Single Phase, half wave, 60Hz, resistive or inductive load
- For capacitive load derate current by 20%

	SYMBOLS	HER 1601C	HER 1602C	HER 1603C	HER 1604C	HER 1605C	HER 1606C	HER 1607C	UNIT
Maximum Repetitive Peak Reverse Voltage	V_{RRM}	50	100	200	300	400	600	800	Volts
Maximum RMS Voltage	V_{RMS}	35	70	140	210	280	420	560	Volts
Maximum DC Blocking Voltage	V_{DC}	50	100	200	300	400	600	800	Volts
Maximum Average Forward Rectified Current At $T_c=100^\circ\text{C}$	$I_{(AV)}$	16.0							Amps
Peak Forward Surge Current 8.3ms single half sine wave superimposed on rated load (JEDEC method)	I_{FSM}	125							Amps
Maximum Instantaneous Forward Voltage at 8.0A	V_F	1.0		1.3		1.5	1.7	Volts	
Maximum DC Reverse Current at rated DC Blocking Voltage at	I_R	$T_A = 25^\circ\text{C}$ 10							μA
		$T_A = 125^\circ\text{C}$ 500							
Maximum Reverse Recovery Time Test conditions $I_F=0.5\text{A}$, $I_R=1.0\text{A}$, $I_{RR}=0.25\text{A}$	t_{rr}	70					100		nS
Typical Junction Capacitance (Measured at 1.0MHz and applied reverse voltage of 4.0V)	C_J	40							pF
Typical Thermal Resistance (NOTE 1)	$R_{\theta JC}$	2.5							$^\circ\text{C}/\text{W}$
Operating Junction Temperature	T_J	(-55 to +150)							$^\circ\text{C}$
Storage Temperature Range	T_{STG}	(-55 to +150)							$^\circ\text{C}$

Notes:

1. Unit mounted on heatsink



HIGH EFFICIENCY GLASS PASSIVATED RECTIFIER

HER1601C THRU HER1607C

VOLTAGE RANGE 50 to 1000 Volts
CURRENT 16.0 Ampere

RATING AND CHARACTERISTIC CURVES HER1601C THRU HER1607C

FIG.1-TYPICAL FORWARD CURRENT DERATING CURVE

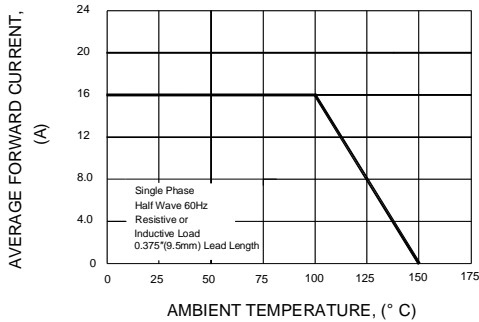

FIG.2-MAXIMUM NON-REPETITIVE PEAK FORWARD SURGE CURRENT

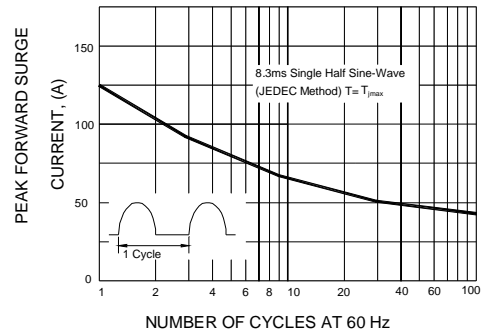

FIG.3-TYPICAL INSTANTANEOUS FORWARD CHARACTERISTICS PER LEG

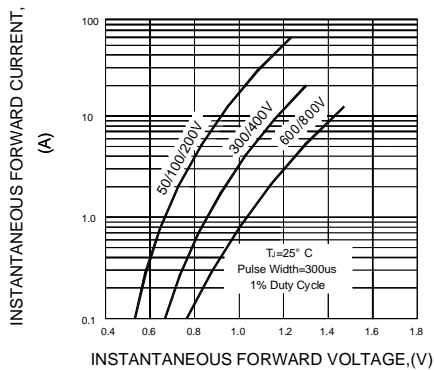

FIG.4-TYPICAL REVERSE CHARACTERISTICS PER LEG

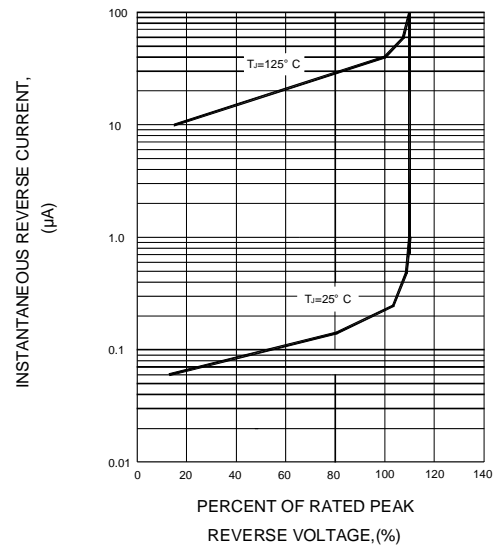

FIG.5-TYPICAL JUNCTION CAPACITANCE PER LEG

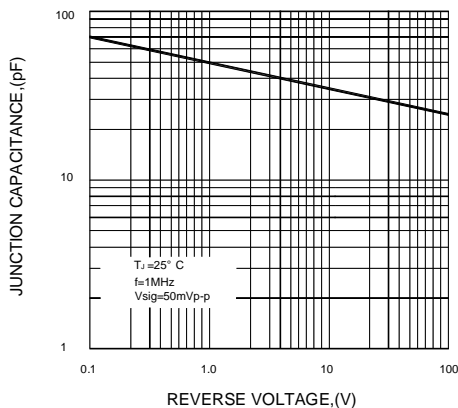
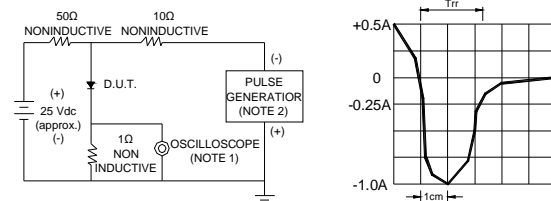

FIG.6-TEST CIRCUIT DIAGRAM AND REVERSE RECOVERY TIME CHARACTERISTIC



- NOTES : 1. Rise Time=7ns max. Input Impedance= 1 megohm. 22pF
2. Rise time=10ns max. Source Impedance= 50 ohms

SET TIME BASE FOR 50/100ns/cm