



# Frontier Electronics Corp.

667 E. COCHRAN STREET, SIMI VALLEY, CA 93065

TEL: (805) 522-9998 FAX: (805) 522-9989

E-mail: [frontiersales@frontierusa.com](mailto:frontiersales@frontierusa.com)

Web: <http://www.frontierusa.com>

## 3A GLASS PASSIVATED SUPER FAST RECOVERY RECTIFIER SF30-005G THRU SF30-06G

### FEATURES

- LOW POWER LOSS, HIGH EFFICIENCY
- LOW FORWARD VOLTAGE
- HIGH CURRENT CAPABILITY
- HIGH SPEED SWITCHING
- HIGH SURGE CAPABILITY
- HIGH RELIABILITY
- GLASS PASSIVATED CHIP JUNCTION

### MECHANICAL DATA

- CASE: MOLDED PLASTIC, DO201AD, DIMENSIONS IN INCHES AND (MILLIMETERS)
- EPOXY: UL 94V-0 MOLDING COMPOUND
- LEADS: MIL-STD-202E, METHOD 208C GUARANTEED
- MOUNTING POSITION: ANY
- WEIGHT: 1.2 GRAMS

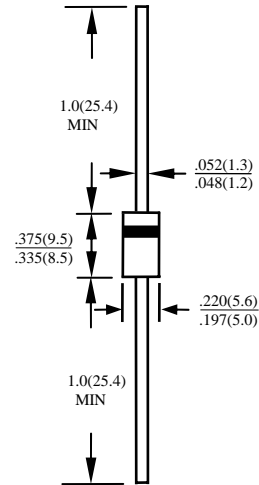

MAXIMUM RATINGS AND ELECTRICAL CHARACTERISTICS RATINGS AT 25°C AMBIENT TEMPERATURE UNLESS OTHERWISE SPECIFIED SINGLE PHASE, HALF WAVE, 60 HZ, RESISTIVE OR INDUCTIVE LOAD. FOR CAPACITIVE LOAD, DERATE CURRENT BY 20%

RATINGS	SYMBOL	SF30-005G	SF30-01G	SF30-015G	SF30-02G	SF30-03G	SF30-04G	SF30-05G	SF30-06G	UNITS
MAXIMUM RECURRENT PEAK REVERSE VOLTAGE	$V_{RRM}$	50	100	150	200	300	400	500	600	V
MAXIMUM RMS VOLTAGE	$V_{RMS}$	35	70	105	140	210	280	350	420	V
MAXIMUM DC BLOCKING VOLTAGE	$V_{DC}$	50	100	150	200	300	400	500	600	V
MAXIMUM AVERAGE FORWARD RECTIFIED CURRENT 0.375"(9.5mm) LEAD LENGTH AT $T_A=55^\circ\text{C}$	$I_O$	3.0								A
PEAK FORWARD SURGE CURRENT, 8.3ms SINGLE HALF SINE-WAVE SUPERIMPOSED ON RATED LOAD	$I_{FSM}$	125								A
TYPICAL JUNCTION CAPACITANCE (NOTE 1)	$C_J$	50				30				PF
TYPICAL THERMAL RESISTANCE (NOTE 2)	$R_{\theta jc}$	30								°C/W
STORAGE TEMPERATURE RANGE	$T_{STG}$	- 55 TO + 150								°C
OPERATING TEMPERATURE RANGE	$T_{OP}$	- 55 TO + 150								°C

### ELECTRICAL CHARACTERISTICS ( $A_T T_A = 25^\circ\text{C}$ UNLESS OTHERWISE NOTED)

CHARACTERISTICS	SYMBOL	SF30-005G	SF30-01G	SF30-015G	SF30-02G	SF30-03G	SF30-04G	SF30-05G	SF30-06G	UNITS
MAXIMUM FORWARD VOLTAGE AT $I_O$ DC	$V_F$	0.95			1.25			1.85		V
MAXIMUM REVERSE CURRENT AT 25°C	$I_R$	10								μA
MAXIMUM REVERSE CURRENT AT 100°C	$I_R$	100								μA
MAXIMUM REVERSE RECOVERY TIME (NOTE 3)	$T_{RR}$	35								nS

NOTE: 1. MEASURED AT 1 MHZ AND APPLIED REVERSE VOLTAGE OF 4.0 VOLTS

2. BOTH LEADS ATTACHED TO HEAT SINK 20×20×1t(mm) COPPER PLATE AT LEAD LENGTH 5mm

3. REVERSE RECOVERY TEST CONDITIONS:  $I_F=0.5A$ ,  $I_R=1.0A$ ,  $I_{RR}=0.25A$

# RATINGS AND CHARACTERISTIC CURVE SF30-005G THRU SF30-06G

FIG. 1-TEST CIRCUIT DIAGRAM AND REVERSE RECOVERY TIME CHARACTERISTIC

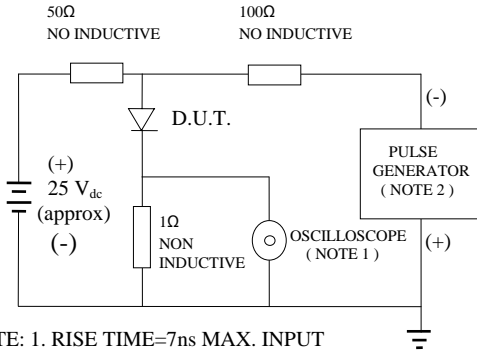

NOTE: 1. RISE TIME=7ns MAX. INPUT IMPEDANCE=1 MOhms 22PF  
2. RISE TIME =10ns MAX. SOURCE IMPEDANCE=50 OHMS

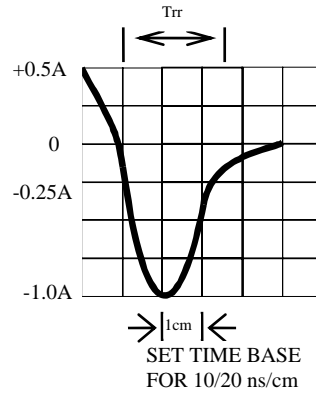

FIG. 2-TYPICAL FORWARD CURRENT DERATING CURVE

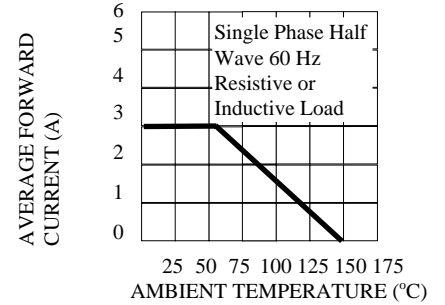

FIG. 3-TYPICAL REVERSE CHARACTERISTICS

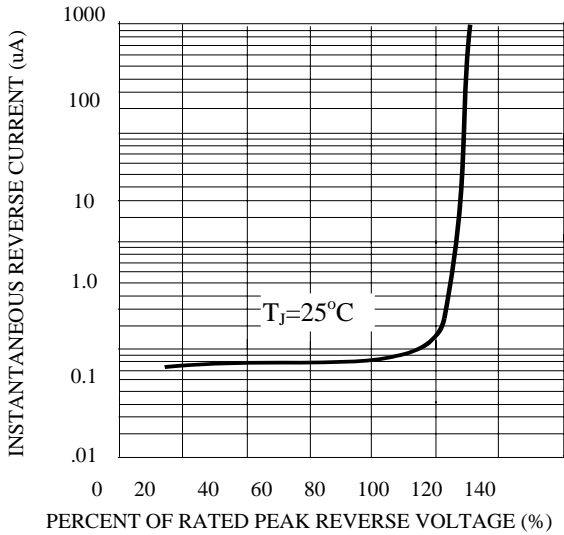

FIG. 4-TYPICAL INSTANTANEOUS FORWARD CHARACTERISTICS

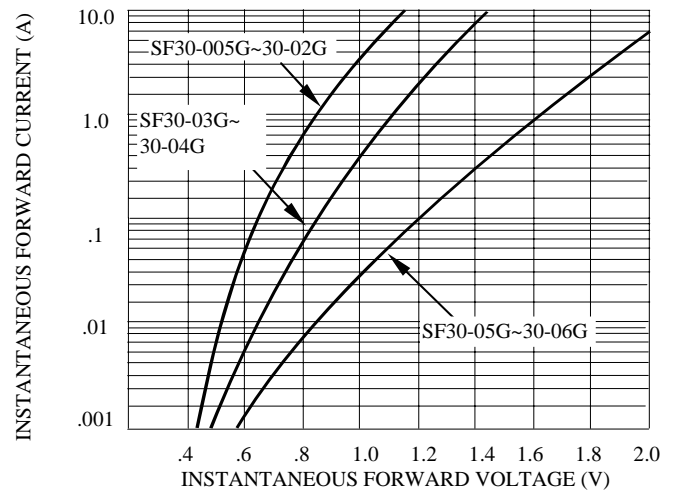

FIG. 5-MAXIMUM NON-REPETITIVE FORWARD SURGE CURRENT

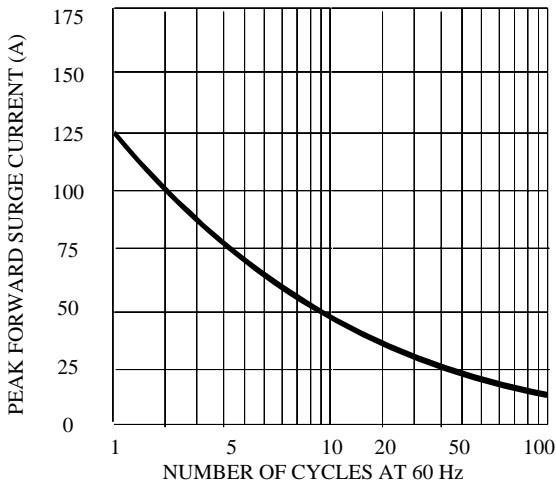

FIG. 6-TYPICAL JUNCTION CAPACITANCE

