



Frontier Electronics Corp.

667 E. COCHRAN STREET, SIMI VALLEY, CA 93065

TEL: (805) 522-9998 FAX: (805) 522-9989

E-mail: frontiersales@frontierusa.com

Web: <http://www.frontierusa.com>

3A SUPER FAST RECOVERY RECTIFIER

SF30-005-LFR THRU SF30-06-LFR

FEATURES

- LOW POWER LOSS, HIGH EFFICIENCY
- LOW FORWARD VOLTAGE
- HIGH CURRENT CAPABILITY
- HIGH SPEED SWITCHING
- HIGH SURGE CAPABILITY
- HIGH RELIABILITY
- ROHS

MECHANICAL DATA

- CASE: MOLDED PLASTIC, DO201AD, DIMENSIONS IN INCHES AND (MILLIMETERS)
- EPOXY: UL 94V-0 MOLDING COMPOUND
- LEADS: MIL-STD-202E, METHOD 208C GUARANTEED
- MOUNTING POSITION: ANY
- WEIGHT: 1.2 GRAMS

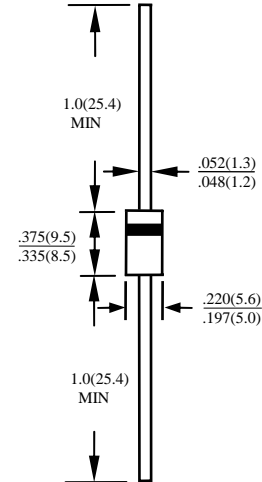

MAXIMUM RATINGS AND ELECTRICAL CHARACTERISTICS RATINGS AT 25°C AMBIENT TEMPERATURE UNLESS OTHERWISE SPECIFIED SINGLE PHASE, HALF WAVE, 60 HZ, RESISTIVE OR INDUCTIVE LOAD. FOR CAPACITIVE LOAD, DERATE CURRENT BY 20%

RATINGS	SYMBOL	SF30 -005-LF R	SF30 -01-LFR	SF30 -015-LF R	SF30 -02-LFR	SF30 -03-LFR	SF30 -04-LFR	SF30 -05-LFR	SF30 -06-LFR	UNITS
MAXIMUM RECURRENT PEAK REVERSE VOLTAGE	V_{RRM}	50	100	150	200	300	400	500	600	V
MAXIMUM RMS VOLTAGE	V_{RMS}	35	70	105	140	210	280	350	420	V
MAXIMUM DC BLOCKING VOLTAGE	V_{DC}	50	100	150	200	300	400	500	600	V
MAXIMUM AVERAGE FORWARD RECTIFIED CURRENT .375" (9.5mm) LEAD LENGTH AT $T_A=55^\circ\text{C}$	I_O	3.0								A
PEAK FORWARD SURGE CURRENT, 8.3ms SINGLE HALF SINE-WAVE SUPERIMPOSED ON RATED LOAD	I_{FSM}	125								A
TYPICAL JUNCTION CAPACITANCE (NOTE 1)	C_J	50				30				PF
TYPICAL THERMAL RESISTANCE (NOTE 2)	$R_{\theta ja}$	30								°C/W
STORAGE TEMPERATURE RANGE	T_{STG}	- 55 TO + 150								°C
OPERATING TEMPERATURE RANGE	T_{OP}	- 55 TO + 150								°C

ELECTRICAL CHARACTERISTICS ($A_T T_A = 25^\circ\text{C}$ UNLESS OTHERWISE NOTED)

CHARACTERISTICS	SYMBOL	SF30 -005-LF R	SF30 -01-LFR	SF30 -015-LF R	SF30 -02-LFR	SF30 -03-LFR	SF30 -04-LFR	SF30 -05-LFR	SF30 -06-LFR	UNITS
MAXIMUM FORWARD VOLTAGE AT I_O DC	V_F	0.95			1.25		1.85			V
MAXIMUM REVERSE CURRENT AT 25°C	I_R	10								μA
MAXIMUM REVERSE CURRENT AT 100°C	I_R	100								μA
MAXIMUM REVERSE RECOVERY TIME (NOTE 3)	T_{RR}	35								nS

NOTE: 1. MEASURED AT 1 MHZ AND APPLIED REVERSE VOLTAGE OF 4.0 VOLTS

2. BOTH LEADS ATTACHED TO HEAT SINK 20x20x1t(mm) COPPER PLATE AT LEAD LENGTH 5mm

3. REVERSE RECOVERY TEST CONDITIONS: $I_F=0.5A$, $I_R=1.0A$, $I_{RR}=0.25A$

RATINGS AND CHARACTERISTIC CURVE SF30-005-LFR THRU SF30-06-LFR

FIG. 1-TEST CIRCUIT DIAGRAM AND REVERSE RECOVERY TIME CHARACTERISTIC

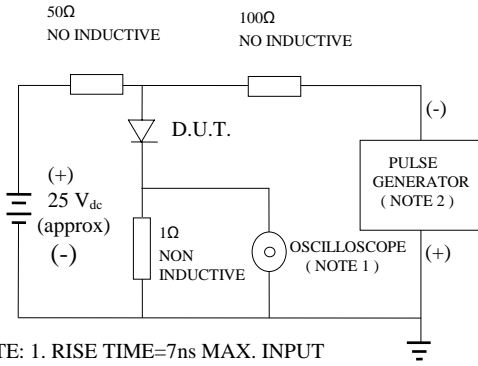

NOTE: 1. RISE TIME=7ns MAX. INPUT IMPEDANCE=1 MOhms 22PF
2. RISE TIME =10ns MAX. SOURCE IMPEDANCE=50 OHMS

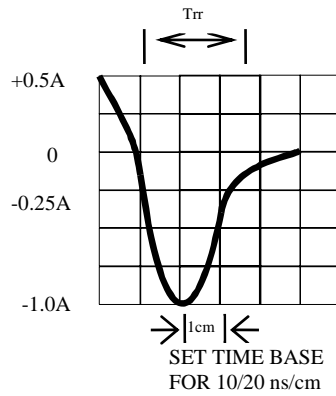

FIG. 2-TYPICAL FORWARD CURRENT DERATING CURVE

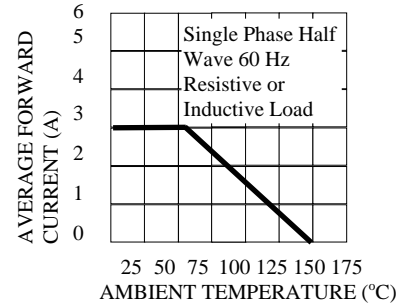

FIG. 3-TYPICAL REVERSE CHARACTERISTICS

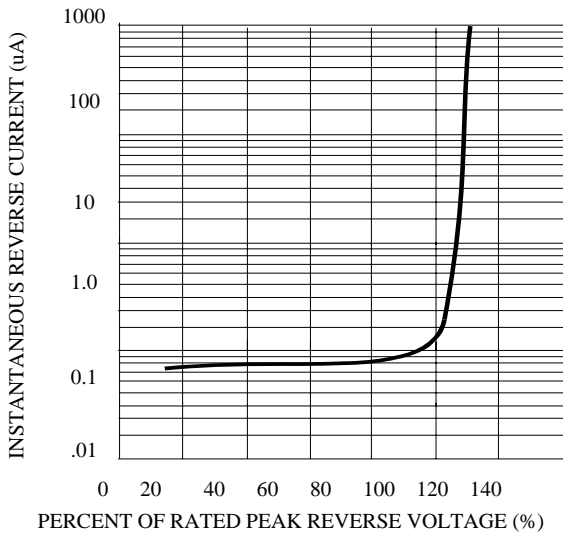

FIG. 4-TYPICAL INSTANTANEOUS FORWARD CHARACTERISTICS

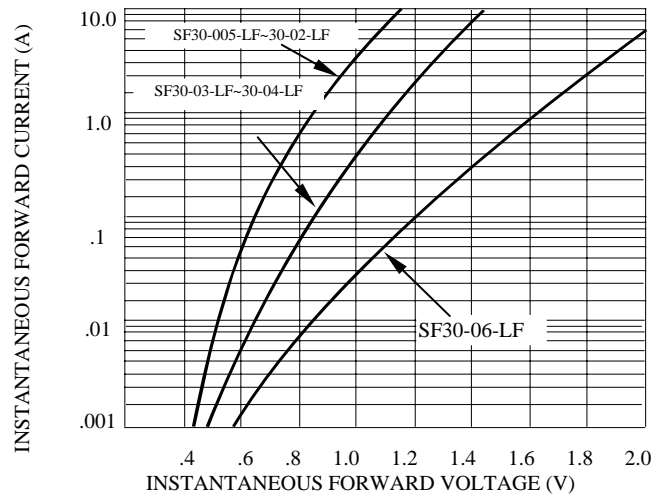

FIG. 5-MAXIMUM NON-REPETITIVE FORWARD SURGE CURRENT

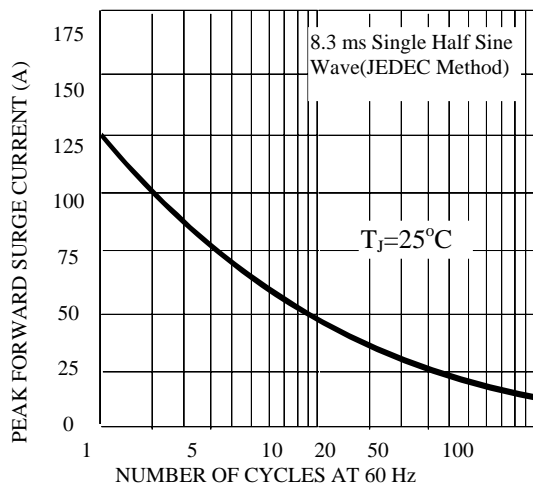

FIG. 6-TYPICAL JUNCTION CAPACITANCE

