

Bimetal Cutouts Temperature Regulators Temperature Limiters

ADVANTAGES

- high pressure resistance
- high response sensitivity
- numerous applications
- various housings, connections and mounting styles

R 20
R 22
R 30
R 32
R 40

DESCRIPTION

Types R 20/R 22/R 40 are **bimetal detectors** and **temperature regulators**.

Types R 30/R 32 are **temperature limiters** (manual reset) without tripfree mechanism.

The thermal response works via a bimetal snap element electrically connected to the switch contact.

The switch system is current insensitive.

The thermal switches react only to external thermal effects. Double contacts ensure high switch performance and long service life.

The housing, base, and the mounting brackets are **voltage-free** (Standard version: base and mounting brackets are aluminium-plated steel).

Heat transfer occurs directly through the metallic base via convection, radiation and conduction in gaseous and solid media.

DIMENSIONS

R 20 / R 22 / R 40

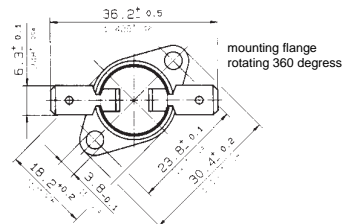
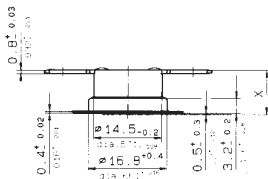

Standard version

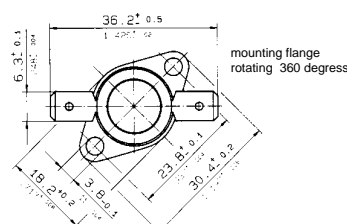
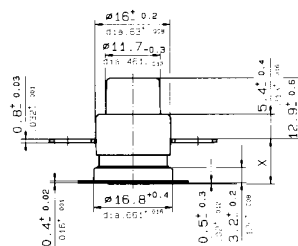

R 30 / R 32

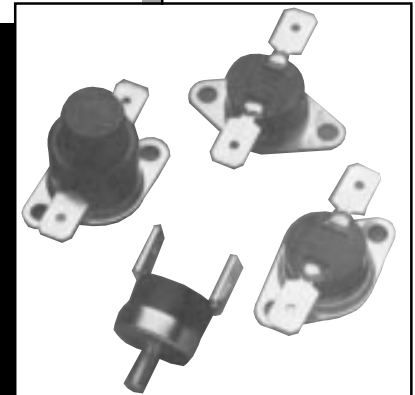

Standard version

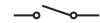

TECHNICAL DATA

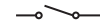
Type	R 20 and R 22	R 30 and R 32	R 40
Voltage rating	* 250 V 50–60 Hz	250 V 50–60 Hz	* 250 V 50–60 Hz
Current rating at $\cos \varphi = 1.0$	* 10.0 A / * 16.0 A	16.0 A	* 10.0 A
Current rating at $\cos \varphi = 0.6$	6.3 A	6.3 A	* 6.3 A
Max. load at $\cos \varphi = 1.0$ 250 V 50–60 Hz 110 V 50–60 Hz 60 V DC 42 V DC 6, 12, 24 V DC	16.0 A / 20.0 A 6.0 A 7.2 A 8.5 A	20.0 A	16.0 A 6.0 A 7.2 A 8.5 A
Contacts Normally closed Normally open	 		 
Switch operations at I_N	* 10 000 0–170 °C / 16 A — * 100 000 50–160 °C / 10 A	* 200	* 30 000
Contact resistance	< 50 mΩ	< 50 mΩ	< 50 mΩ
Nominal temperature range	0 °C to +170 °C	+30 °C to +160 °C	+50 °C to +160 °C
Tolerance but at least	±3% ±6% ±10% ±3 K ±5 K ±10 K	±3% ±6% ±10% ±3 K ±5 K ±10 K	±3% ±6% ±10% ±3 K ±5 K ±10 K
Max. permanent temperature	* 175 °C	* 175 °C	* 175 °C
Dielectric strength Housing to earth	R 20: 3000 V _{eff} 50–60 Hz R 22: 4000 V _{eff} 50–60 Hz	R 30: 3000 V _{eff} 50–60 Hz R 32: 4000 V _{eff} 50–60 Hz	3000 V _{eff} 50–60 Hz
Dielectric strength across open contacts	1500 V _{eff} 50/60 Hz	1500 V _{eff} 50/60 Hz	1500 V _{eff} 50/60 Hz
Housing material	Duroplast	Duroplast	Duroplast
Housing insulation	on request	on request	on request
Overall height (mm)	R 20 9.5 ^{+0.2} R 22 11.5 ^{+0.2}	R 30 9.5 ^{+0.2} R 32 11.5 ^{+0.2}	R 40 12.0 ^{+0.2}

Note: * Approved nominal values. Other specific values on request.

AREAS OF APPLICATION

Temperature regulation, temperature monitoring, temperature limiting and indication in electric appliances and industrial equipment, machinery and process engineering.

Examples:

Vacuum cleaners	Electrical house-
Ironing machines	hold appliances
Cooking equipment	Electronic circuits
Dampers	Machinery
Heat radiators	Process engineering
Hot water heaters	Industrial electric
Coffee machines	elements
Egg boilers	Electrical components
Electric appliances	

RESPONSE TEMPERATURE, TOLERANCE, CODE-NO.

Nominal temperatures between 50 and 160 °C in 5 °C steps.

Nominal temperatures in geometrical series as per DIN 323 in °C.

For tolerance, see above – Technical Data.

Temperature code – 3 digits

Minimum rate of temperature change

0.1 K/min., max. 1.0 K/min.

RESET TEMPERATURES

Reset temperature will be between 5 °C and 50 °C below the standard response temperatures.

INSTALLATION/MOUNTING INFORMATION

Incorporation of the thermo-switch directly in the heat source or attachment to it, is possible without additional insulation.

Slightest changes in temperature are conducted through the metallic housing cap directly to the bimetal snap disc of the thermo-switch. This ensures that time delays of thermal control systems are kept very small: insensitive to installation position. The dust-proof and damp-proof construction of the thermo-switch allows various methods of attachment to, and incorporation in appliances.

To ensure the best heat transition, the cap respectively the mounting bracket should be soldered, rivetted, screwed or spot-welded to the heat source.

OPTIONAL VARIATIONS Terminals, Fixings, Housings

Type			Description old	Description new	Variations Terminals	
R 20/R 22	R 30/R 32	R 40	A 008	AA008	Flat terminal for screw connection	**
R 20/R 22	R 30/R 32	R 40	A 117	AB 117	6.3 x 0.8 mm terminal	**
R 20/R 22	R 30/R 32	R 40	A 118	AC118	4.8 x 0.8 mm terminal	**
R 20/R 22		R 40	A 119	AD119	6.3 x 0.8 mm terminal, angle 90°	*
R 20/R 22		R 40	A 120	AE120	4.8 x 0.8 mm terminal, angle 90°	**
R 20/R 22	R 30/R 32	R 40	A 121	AF121	solder connection	*
R 20/R 22		R 40	A 122	AG122	solder connection, angle 90°	**
R 20/R 22		R 40	A 123	AH123	flat conductors	**
R 20/R 22		R 40	A 125	AI125	connector pins 4.8 x 0.5 mm	**
R 20/R 22	R 30/R 32	R 40	A128	AK128	screw connection	**
R 20/R 22	R 30/R 32	R 40	A129	AL129	crimp connection	**
R 20/R 22		R 40	A 134	AM134	A119 with inside angled connection 6.3 x 0.8 mm	**
R 20/R 22		R 40	A 135	AN 135	A120 with inside angled connection 4.8 x 0.8 mm	**
R 20/R 22	R 30/R 32	R 40	A 137	AP137	crimp connection/ screw connection	**
R 20/R 22	R 30/R 32	R 40	A 138	AR138	crimp connection/flat terminal	**
R 20/R 22	R 30/R 32	R 40	A139	AS139	screw connection/flat terminal	**
Type			Description old	Description new	Variations Fixings	
R 20/R 22	R 30/R 32	R 40	B000	BX000	no mounting bracket	**
R 20/R 22	R 30/R 32	R 40	B 120	BA120	3 hole mounting flange	*
R 20/R 22	R 30/R 32	R 40	B 214	BB214	mounting bracket, narrow	*
R 20/R 22	R 30/R 32	R 40	B 215	BC215	mounting bracket-standard hole dia. 3.2 mm	**
R 20/R 22	R 30/R 32	R 40	B 217	BD217	brass central mounting M 5 x 6 mm	*
R 20/R 22	R 30/R 32	R 40	B 218	BE218	brass central mounting M 4 x 8 mm	**
R 20/R 22	R 30/R 32	R 40	B 220	BU220	fixed mounting flange, steel, hole distance 23 mm, angle 0°	**
R 20/R 22	R 30/R 32	R 40	B 221	BG221	fixed mounting flange, steel, hole distance 23 mm, angle 45°	**
R 20/R 22	R 30/R 32	R 40	B 222	BH222	fixed mounting flange, steel, hole distance 23 mm, angle 90°	**

Type			Description old	Description new	Variations Fixings	
R 20/R 22	R 30/R 32	R 40	B 223	BI223	fixed mounting flange, steel, hole distance 23 mm, angle 135°	*
R 20/R 22	R 30/R 32	R 40	B 225	BF225	fixed mounting flange, steel, hole distance 40 mm, narrow, angle 0°	**
R 20/R 22	R 30/R 32	R 40	B 226	BL226	fixed mounting flange, steel, hole distance 40 mm, narrow, angle 45°	**
R 20/R 22	R 30/R 32	R 40	B 227	BM227	fixed mounting flange, steel, hole distance 40 mm, narrow, angle 90°	**
R 20/R 22	R 30/R 32	R 40	B 228	BN228	fixed mounting flange, steel, hole distance 40 mm, narrow, angle 135°	*
R 20/R 22	R 30/R 32	R 40	B 235	BP235	raised flange, hole distance 23 mm, angle 0°	**
R 20/R 22	R 30/R 32	R 40	B 236	BR236	raised flange, hole distance 23 mm, angle 45°	**
R 20/R 22	R 30/R 32	R 40	B 237	BS237	raised flange, hole distance 23 mm, angle 90°	**
R 20/R 22	R 30/R 32	R 40	B 238	BT238	raised flange, hole distance 23 mm, angle 135°	**
R 20/R 22	R 30/R 32	R 40	B 250	BK250	with rotating mounting flange (Standard) hole dia. 3.8 mm	**
R 20/R 22	R 30/R 32	R 40	B 255	BV255	mounting element	*
Type			Description old	Description new	Variations Housings	
R 20/R 22		R 40	G 108	GA108	hexagon threaded sleeve, brass, with flat terminals 6.3 x 0.8 mm	*
	R 30		G128	GB128	without rubber cap, with reset pin	*
	R 32		G 129	GC129	without rubber cap, with reset pin	*
R 20/R 22		R 40	G 130	GD130	plastic cover horizontal, for leads and cable	**
	R 30/R 32		G 135	GE135	housing without reset pin	**
R 20/R 22		R 40	G 145	GF145	hexagon threaded sleeve, brass, with sensor and leads 300 mm	**
R 20/R 22		R 40	G 146	GG146	hard paper sleeve	**
R 20/R 22		R 40	G 147	GH147	voltage-free housing with flange, for leads	**
	R 30/R 32		G 408	GI408	cap silicone R 300019	**
	R 30/R 32		G 409	GK409	without reset cap	**

Reference to: page 4/5 - * see illustrations
** not illustrated

Marking (example)

Manufacturer = MIC Version = ABXX
Version = BD16 Temperature = C029

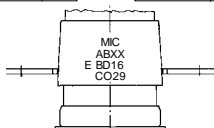

Type	Terminals	Ref. letter	Housing	Standard	Fixing	Code letter	Base	1996	60 °C ±5 K
R22	A	B	X	X	B	D	1	6	C029

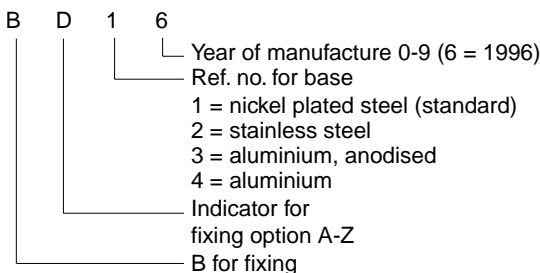
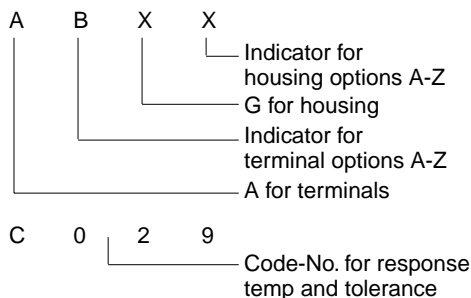

R 20 / R 22 / R 30 / R 32 / R 40
B 120 3 hole mounting flange

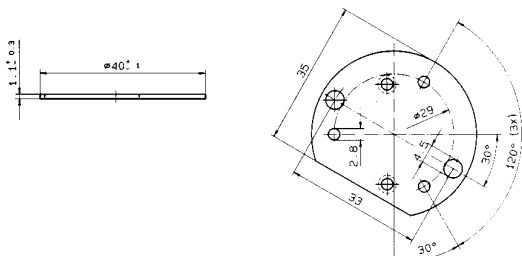

R 20 / R 22 / R 30 / R 32 / R 40
B 255 Mounting element

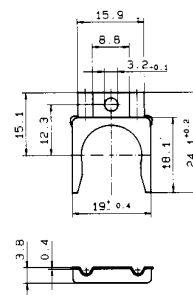

EXAMPLES
of Connectors, Mountings and Housing Types

R 20 / R 22 / R 40

A 119 with 6.3 x 0.8 mm push-on terminals, angle 90°

A 120 with 4.8 x 0.8 mm push-on terminals, angle 90°

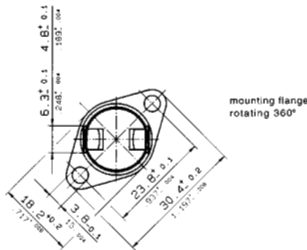
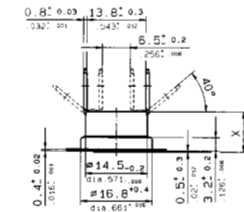

R 20 / R 22 / R 40

A 121 with solder connection

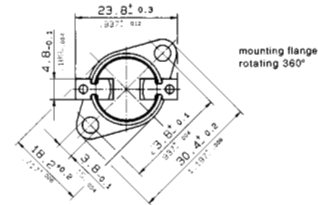
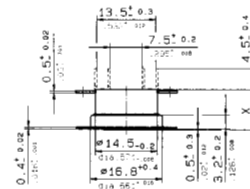

R 20 / R 22 / R 40

B 214 mounting bracket, narrow

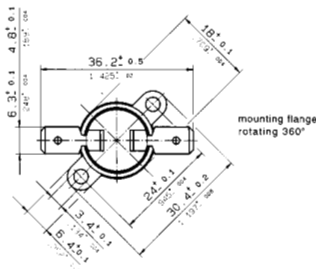
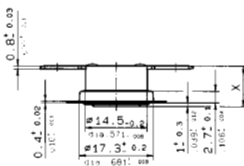

R 20 / R 22 / R 40

B 223 fixed mounting flange, steel

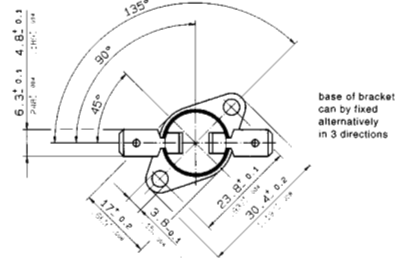
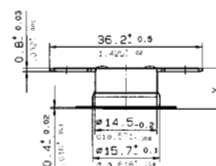

R 20 / R 22 / R 40

B 228 fixed mounting flange, steel
hole distance 40 mm, narrow,
angle 135°

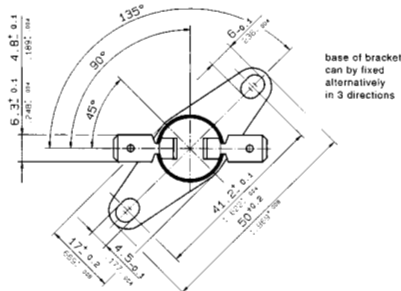
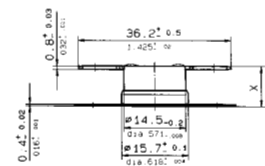

R 20 / R 22 / R 40

B 238 raised flange, hole distance 23 mm,
angle 135°

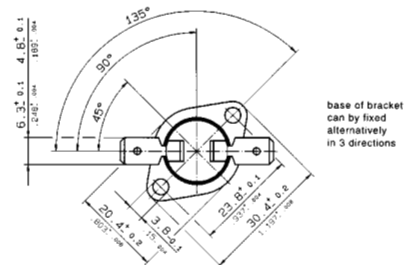
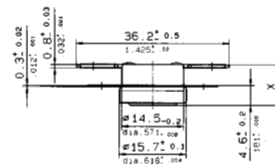

EXAMPLES
of Connectors, Mountings and Housing Types

R 30 / R 32
B 217 brass central mounting
M 5 x 6 mm

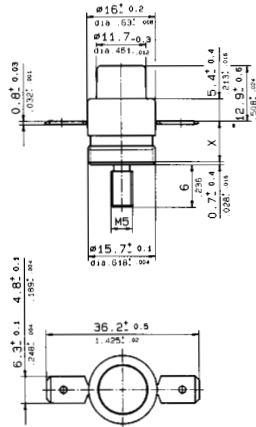

R 30 / R 32
B 223 fixed mounting flange, steel

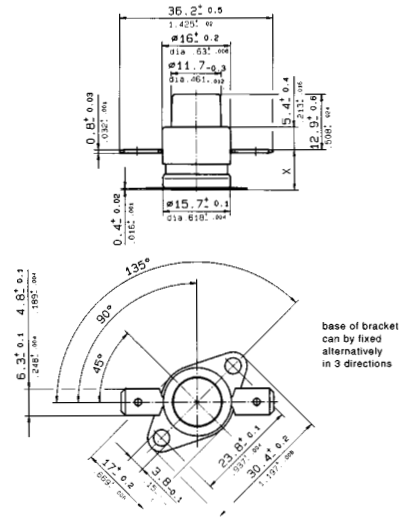

R 30 / R 32
B 228 fixed mounting flange, steel,
hole distance 40 mm, narrow,
angle 135°

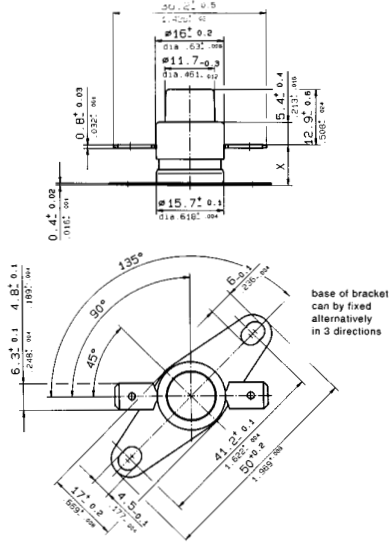

R 30 / R 32
B 238 raised flange, hole distance 23 mm,
angle 135°

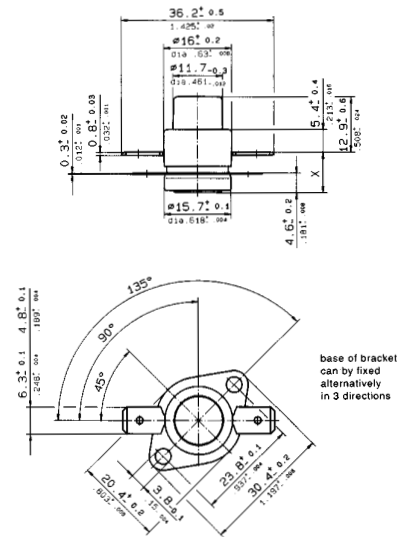

R 20 / R 22 / R 40
G 108 hexagonal head, threaded,
brass

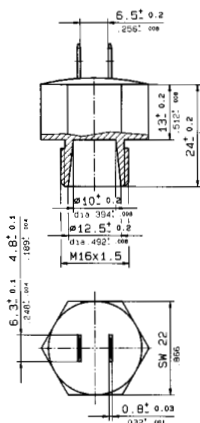

R 30
G 128 with reset pin

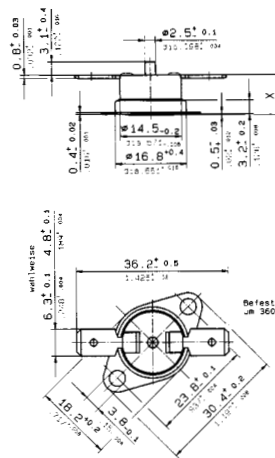

R 32
G 129 with reset knob

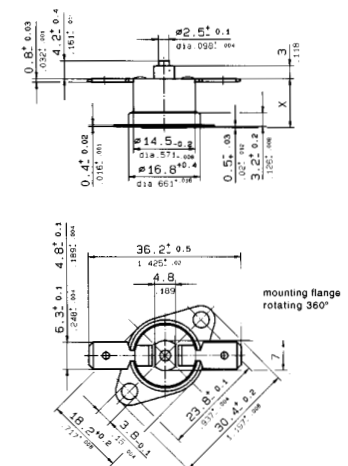

NOMINAL RESPONSE TEMPERATURE, TOLERANCE, CODE-NO.

Series 10 Tol. ± 10 %		Series 20 Tol. ± 6 %		Series 40 Tol. ± 3 %	
°C	Code No.	°C	Code No.	°C	Code No.
Normally closed					
000	007	000	008	000	009
		02	131	02	132
05	010	05	133	05	134
				08	135
10	011	10	136	10	137
				12	138
		14	139	14	140
15	012	15	013	15	014
				16	141
		18	142	18	143
20	015	20	016	20	144
		22	145	22	146
25	017	25	018	25	019
		26	147	26	148
		28	020	28	021
30	022	30	149	30	150
				33	151
35	023	35	152	35	153
				37	154
40	024	40	155	40	156
				42	157
45	025	45	158	45	159
				47	160
50	161	50	162	50	163
53	026	53	027	53	164
56	028	56	165	56	166
60	030	60	029	60	167
63	168	63	169	63	170
67	031	67	032	67	171
71	033	71	172	71	173
75	034	75	035	75	174
80	175	80	176	80	177
85	036	85	037	85	178
90	038	90	179	90	180
95	039	95	040	95	181
100	182	100	183	100	184
106	041	106	042	106	185
112	043	112	186	112	187
118	044	118	045	118	188
125	189	125	190	125	191
132	046	132	047	132	192
140	048	140	193	140	194
150	049	150	050	150	195
160	196	160	197	160	198
				170	199

Series 10 Tol. ± 10 %		Series 20 Tol. ± 6 %		Series 40 Tol. ± 3 %	
°C	Code No.	°C	Code No.	°C	Code No.
Normally open					
000	257	000	258	000	259
		02	331	02	332
05	260	05	333	05	334
				08	335
10	261	10	336	10	337
				12	338
		14	339	14	340
15	262	15	263	15	264
				16	341
		18	342	18	343
20	265	20	266	20	344
		22	345	22	346
25	267	25	268	25	269
		26	347	26	348
		28	270	28	271
30	272	30	349	30	350
				33	351
35	273	35	352	35	353
				37	354
40	274	40	355	40	356
				42	357
45	275	45	358	45	359
				47	360
50	361	50	362	50	363
53	276	53	277	53	364
56	278	56	365	56	366
60	280	60	279	60	367
63	368	63	369	63	370
67	281	67	282	67	371
71	283	71	372	71	373
75	284	75	285	75	374
80	375	80	376	80	377
85	286	85	287	85	378
90	288	90	379	90	380
95	289	95	290	95	381
100	382	100	383	100	384
106	291	106	292	106	385
112	293	112	386	112	387
118	294	118	295	118	388
125	389	125	390	125	391
132	296	132	297	132	392
140	298	140	393	140	394
150	299	150	300	150	395
160	396	160	397	160	398

SPECIAL TEMPERATURE SETTINGS

Response temperatures and reset temperatures with specific values and alternative tolerance can be supplied.

SPECIAL CONNECTIONS

Leads or solid wire from 0.25 mm² to 1.0 mm².
Lengths from 40 mm to 10 000 mm,
with or without stripping possible.
Lead ends with DIN connectors or shrouds.
Freon and oil resistant leads,
PTFE-, PVF², Nomex and Silicone leads
available from stock.

SPECIAL HOUSINGS

When selecting the switch-off temperatures of thermostats in special housings or with non-standard mounting, the time delay due to the thermal mass of the housing/mounting has to be considered.

Closer tolerances of nominal switch-off temperatures and reset temperatures, as well as small differentials, are also available **for small quantities** on request.

QUALITY STANDARD

Production item testing
Voltage test, switch function,
Nominal response temperature

APPROVALS

Life expectancy, voltage rating and current rating comply with VDE 0631 or EN 60730, see page 2.
Further approvals obtained for many countries.
Information on request.

ORDERING INFORMATION

Quantity	Type	Code	Temperature °C	Version	Tolerance
6000	R 22	C 183	100	A 119	± 6 %

Technical data and other specifications may be altered without prior notice.

CANTHERM

8415 Mountain Sights Avenue • Montreal (Quebec), H4P 2B8, Canada
Tel: (514) 739-3274 • 1-800-561-7207 • Fax: (514) 739-290
E-mail : sales@cantherm.com • Website: www.cantherm.com