

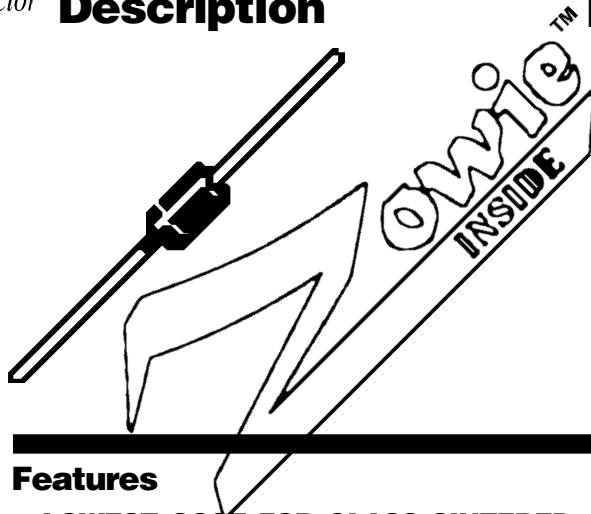

# 3.0 Amp Glass Passivated Sintered Fast Switching Rectifiers

## Description

**RGPZ30A . . . 30M Series**



## Mechanical Dimensions

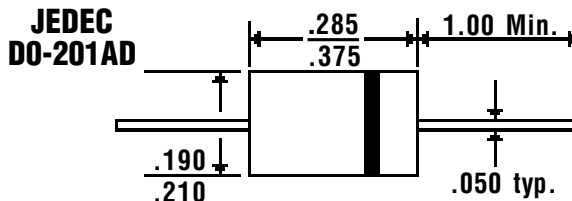

### Features

- **LOWEST COST FOR GLASS SINTERED FAST SWITCHING CONSTRUCTION**
- **LOWEST  $V_f$  FOR GLASS SINTERED FAST SWITCHING CONSTRUCTION**
- **TYPICAL  $I_r < 100$  nAmps**
- **3.0 AMP OPERATION @  $T_A = 55^\circ\text{C}$ , WITH NO THERMAL RUNAWAY**
- **SINTERED GLASS CAVITY-FREE JUNCTION**

Electrical Characteristics @ 25°C.	RGPZ30A . . . 30M Series							Units
Maximum Ratings	30A	30B	30D	30G	30J	30K	30M	
Peak Repetitive Reverse Voltage... $V_{RRM}$	50	100	200	400	600	800	1000	Volts
RMS Reverse Voltage... $V_{R(rms)}$	35	70	140	280	420	560	700	Volts
DC Blocking Voltage... $V_{DC}$	50	100	200	400	600	800	1000	Volts
Average Forward Rectified Current... $I_{F(av)}$ Current 3/8" Lead Length @ $T_A = 55^\circ\text{C}$	3.0							Amps
Non-Repetitive Peak Forward Surge Current... $I_{FSM}$ 8.3mS, 1/2 Sine Wave Superimposed on Rated Load	125							Amps
Forward Voltage @ Rated Forward Current and 25°C... $V_f$	1.2							Volts
Full Load Reverse Current... $I_R(av)$ Full Cycle Average @ $T_A = 55^\circ\text{C}$	100							$\mu\text{Amps}$
DC Reverse Current... $I_{R(max)}$ @ Rated DC Blocking Voltage				$T_A = 25^\circ\text{C}$	5.0			$\mu\text{Amps}$
				$T_A = 150^\circ\text{C}$	200			$\mu\text{Amps}$
Typical Junction Capacitance... $C_j$ (Note 1)	60							pF
Maximum Thermal Resistance... $R_{\theta JA}$ (Note 2)	16							$^\circ\text{C/W}$
Maximum Reverse Recovery Time... $t_{RR}$ (Note 3)	< ..... 150 ..... > 250 < ..... 500 ..... >							nS
Operating & Storage Temperature Range... $T_j, T_{STRG}$	-65 to 175							$^\circ\text{C}$

# 3.0 Amp Glass Passivated Sintered Fast Switching Rectifiers

**RGPZ30A . . . 30M Series**

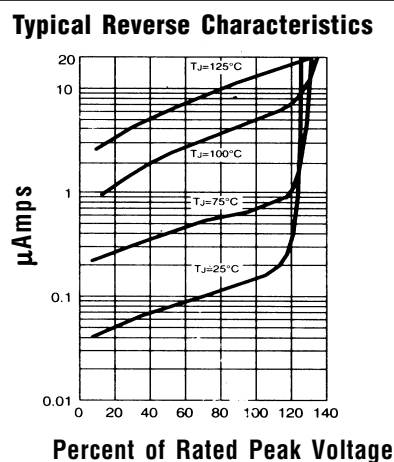
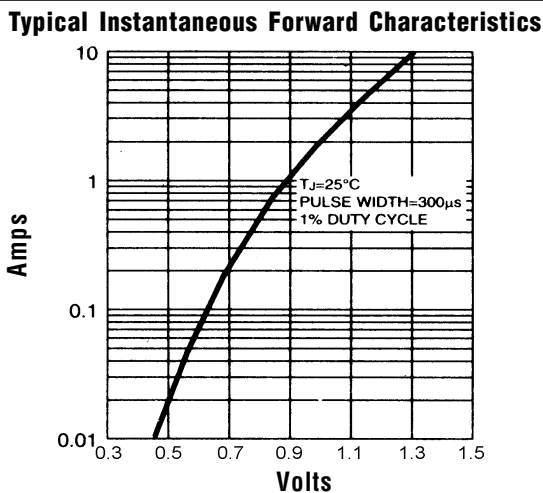
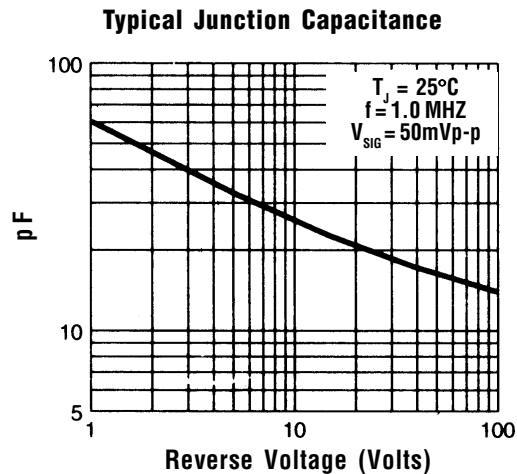
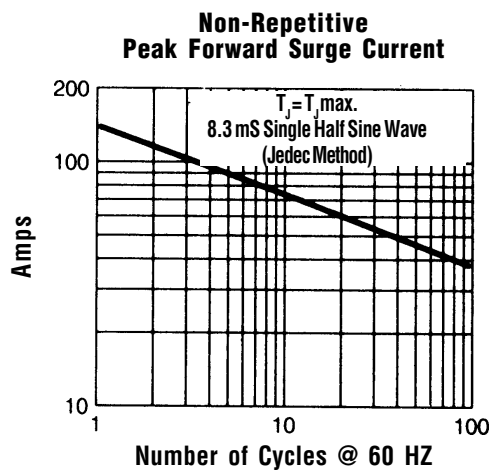
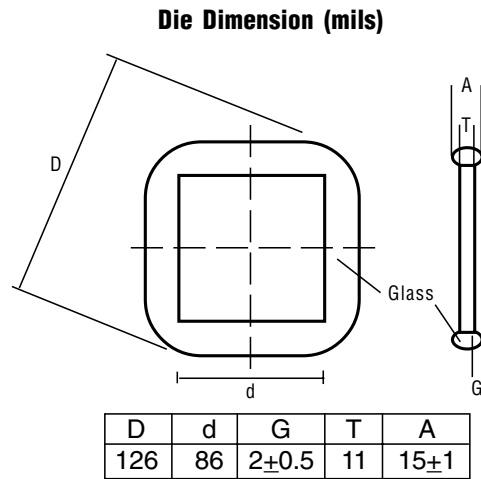
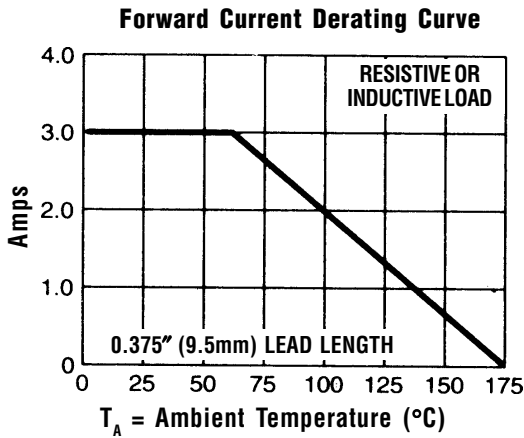

Ratings at 25 Deg. C ambient temperature unless otherwise specified.

Single Phase Half Wave, 60 HZ Resistive or Inductive Load.

For Capacitive Load, Derate Current by 20%.

- NOTES:**
1. Measured @ 1 MHz and applied reverse voltage of 4.0V.
  2. Thermal Resistance from Junction to Ambient at 3/8" Lead Length, P.C. Board Mounted.
  3. Reverse Recovery Condition  $I_F = 0.5\text{A}$ ,  $I_R = 1.0\text{A}$ ,  $I_{RR} = 0.25\text{A}$ .