

# SYNCHRONOUS BURST SRAM PIPELINED OUTPUT

## 64K x 64 SRAM

+3.3V SUPPLY, FULLY REGISTERED  
 INPUTS AND OUTPUTS, BURST COUNTER

### FEATURES

- Fast access times: 5, 6, and 7ns
- Fast clock speed: 100, 83, and 66 MHz
- Provide high performance 3-1-1 access rate
- Fast OE# access times: 5, 6, and 7ns
- Optimal for depth expansion (one cycle chip deselect to eliminate bus contention)
- 3.3V -5% and +10% core power supply, 2.5V or 3.3V I/O supply
- 5V tolerant inputs except I/O's
- Clamp diodes to VSS at all inputs and outputs
- Common data inputs and data outputs
- BYTE WRITE ENABLE and GLOBAL WRITE control
- Four chip enables for depth expansion and one chip enable for address pipeline
- Address, control, input, and output pipeline registers
- Internally self-timed WRITE CYCLE
- Burst sequence control pins MODE (interleaved or linear burst sequence)
- Automatic power-down for portable applications
- ZZ pin for snooze control
- High density, high speed packages
- High 30pF output drive capability at rated access time

### OPTIONS

- Timing
  - 5ns access/10ns cycle
  - 6ns access/12ns cycle
  - 7ns access/15ns cycle
- Package
  - 128-pin PQFP
  - 128-pin TQFP

### MARKING

-5  
 -6  
 -7  
  
 Q  
 T

### GENERAL DESCRIPTION

The Galvantech Synchronous Burst SRAM family employs high-speed, low power CMOS designs using advanced triple-layer polysilicon, double-layer metal technology. Each memory cell consists of four transistors and two high valued resistors.

The GVT7164D64 SRAM integrates 65,536x64 SRAM cells with advanced synchronous peripheral circuitry and a 2-bit counter for internal burst operation. All synchronous inputs are gated by registers controlled by a positive-edge-triggered clock input (CLK). The synchronous inputs include all addresses, all data inputs, address-pipelining chip enable (CE#), depth-expansion chip enables (CE2#, CE3#, CE2 and CE3), burst control inputs (ADSC#, ADSP#, and ADV#), write enables (BW1# to BW8#, and BWE#), and global write (GW#).

Asynchronous inputs include the output enable (OE#) and burst mode control (MODE). The data outputs (Q), enabled by OE#, are also asynchronous.

Addresses and chip enables are registered with either address status processor (ADSP#) or address status controller (ADSC#) input pins. Subsequent burst addresses can be internally generated as controlled by the burst advance pin (ADV#).

Address, data inputs, and write controls are registered on-chip to initiate self-timed WRITE cycle. WRITE cycles can be one to eight bytes wide as controlled by the write control inputs. Individual byte write allows individual byte to be written. BW1# controls DQ1-DQ8. BW2# controls DQ9-DQ16. BW3# controls DQ17-DQ24. BW4# controls DQ25-DQ32. BW5# controls DQ33-DQ40. BW6# controls DQ41-DQ48. BW7# controls DQ49-DQ56. BW8# controls DQ57-DQ64. BW1#, BW2#, BW3#, BW4#, BW5#, BW6#, BW7#, and BW8# can be active only with BWE# being LOW. GW# being LOW causes all bytes to be written.

The GVT7164D64 operates from a +3.3V power supply. All inputs and outputs are TTL-compatible. The device is ideally suited for 486, Pentium™, 680x0, and PowerPC™ systems and for systems that are benefited from a wide synchronous data bus.

## FUNCTIONAL BLOCK DIAGRAM

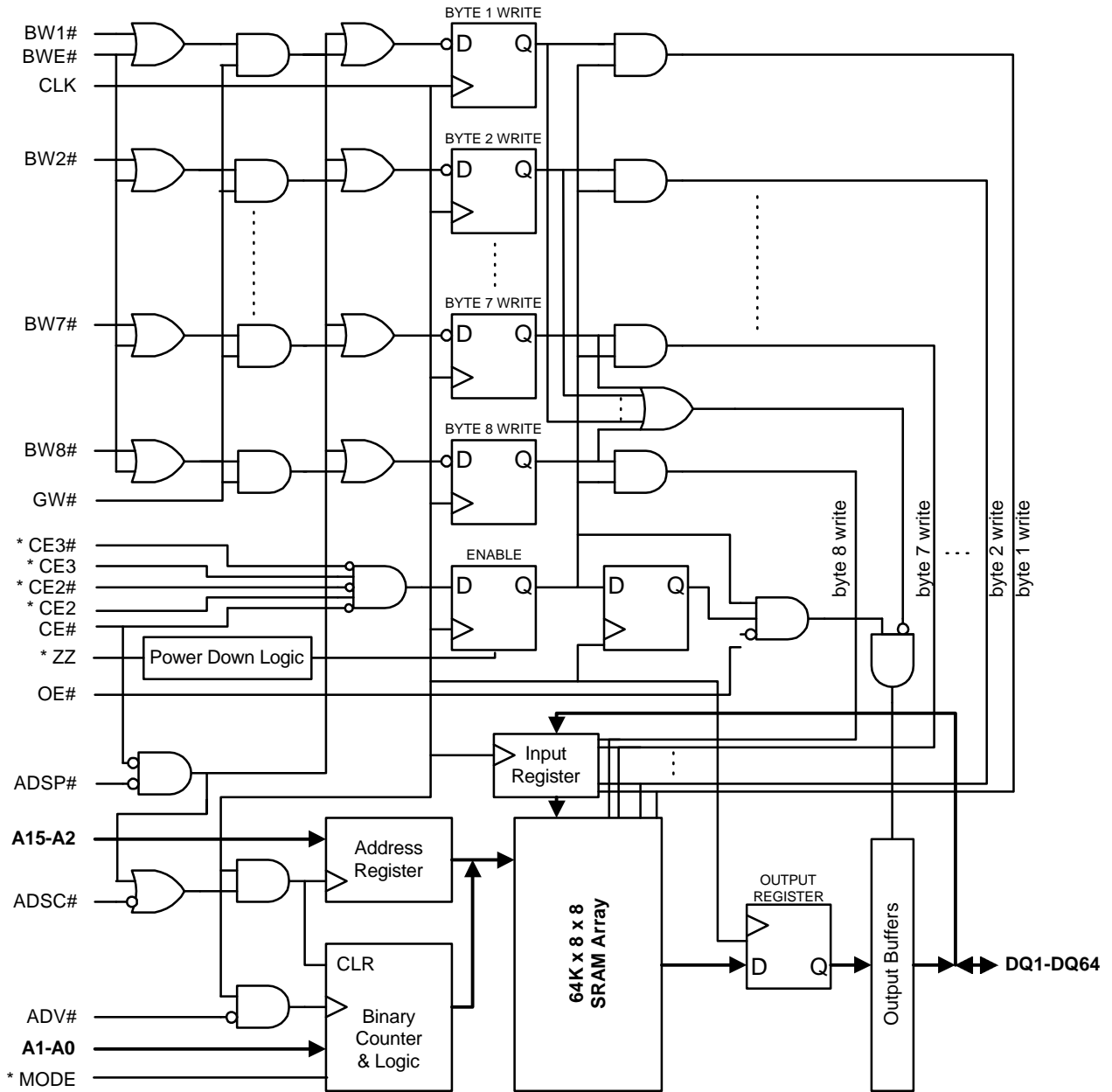

**NOTE:** The Functional Block Diagram illustrates simplified device operation. See Truth Table, pin descriptions and timing diagrams for detailed information.

## PIN ASSIGNMENT (Top View)

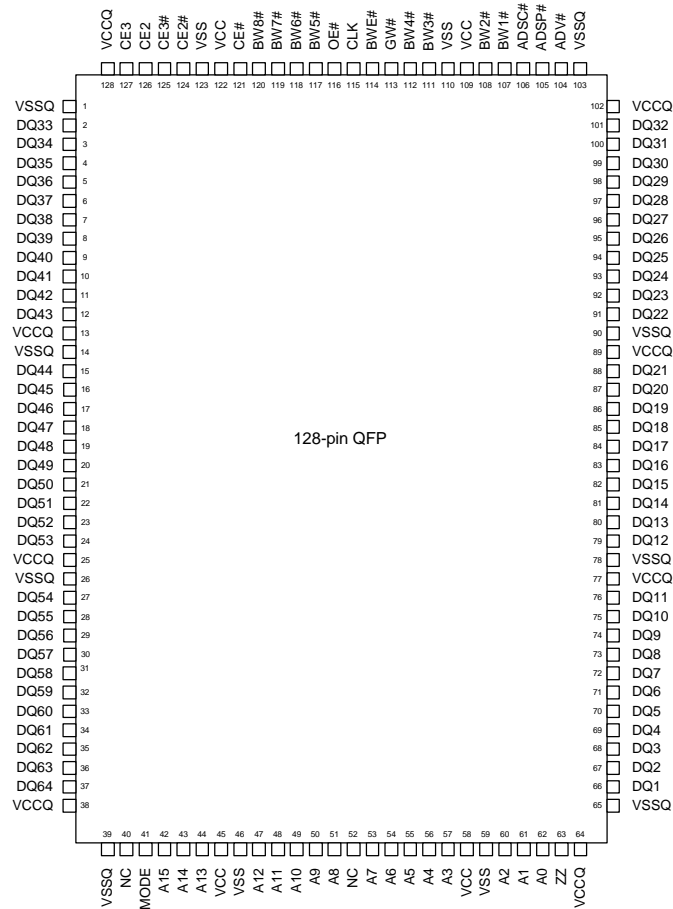

## PIN DESCRIPTIONS

GVT7164D64 PINS	SYMBOL	TYPE	DESCRIPTION
62, 61, 60, 57, 56, 55, 54, 53, 51, 50, 49, 48, 47, 44, 43, 42	A0-A15	Input-Synchronous	Addresses: These inputs are registered and must meet the setup and hold times around the rising edge of CLK. The burst counter generates internal addresses associated with A0 and A1, during burst cycle and wait cycle.
107, 108, 111, 112, 117, 118, 119, 120	BW1#, BW2#, BW3#, BW4#, BW5#, BW6#, BW7#, BW8#	Input-Synchronous	Byte Write: A byte write is LOW for a WRITE cycle and HIGH for a READ cycle. BW1# controls DQ1-DQ8. BW2# controls DQ9-DQ16. BW3# controls DQ17-DQ24. BW4# controls DQ25-DQ32. BW5# controls DQ33-DQ40. BW6# controls DQ41-DQ48. BW7# controls DQ49-DQ56. BW8# controls DQ57-DQ64. Data I/O are high impedance if either of these inputs are LOW, conditioned by BWE# being LOW.
114	BWE#	Input-Synchronous	Write Enable: This active LOW input gates byte write operations and must meet the setup and hold times around the rising edge of CLK.
113	GW#	Input-Synchronous	Global Write: This active LOW input allows a full 64-bit WRITE to occur independent of the BWE# and BWn# lines and must meet the setup and hold times around the rising edge of CLK.
115	CLK	Input-Synchronous	Clock: This signal registers the addresses, data, chip enables, write control and burst control inputs on its rising edge. All synchronous inputs must meet setup and hold times around the clock's rising edge.
121	CE#	Input-Synchronous	Chip Enable: This active LOW input is used to enable the device and to gate ADSP#.

## PIN DESCRIPTIONS (continued)

GVT7164D64 PINS	SYMBOL	TYPE	DESCRIPTION
124, 125	CE2#, CE3#	Input-Synchronous	Chip Enable: This active LOW input is used to enable the device.
126, 127	CE2, CE3	Input-Synchronous	Chip enable: This active HIGH input is used to enable the device.
116	OE#	Input-Asynchronous	Output Enable: This active LOW asynchronous input enables the data output drivers.
104	ADV#	Input-Synchronous	Address Advance: This active LOW input is used to control the internal burst counter. A HIGH on this pin generates wait cycle (no address advance).
105	ADSP#	Input-Synchronous	Address Status Processor: This active LOW input, along with CE# being LOW, causes a new external address to be registered and a READ cycle is initiated using the new address.
106	ADSC#	Input-Synchronous	Address Status Controller: This active LOW input causes device to be de-selected or selected along with new external address to be registered. A READ or WRITE cycle is initiated depending upon write control inputs.
41	MODE	Input-Static	Mode: This input selects the burst sequence. A LOW on this pin selects LINEAR BURST. A NC or HIGH on this pin selects INTERLEAVED BURST.
63	ZZ	Input-Asynchronous	Snooze: This active HIGH input puts the device in low power consumption standby mode. For normal operation, this input has to be either LOW or NC (No Connect).
66-76, 79-88, 91-101, 2-12, 15-24, 27-37	DQ1-DQ64	Input/Output	Data Inputs/Outputs: First Byte is DQ1-DQ8. Second Byte is DQ9-DQ16. Third Byte is DQ17-DQ24. Fourth Byte is DQ25-DQ32. Fifth Byte is DQ33-DQ40. Sixth Byte is DQ41-DQ48. Seventh Byte is DQ49-DQ56. eighth Byte is DQ57-DQ64. Input data must meet setup and hold times around the rising edge of CLK.
45, 58, 109, 122	VCC	Supply	Power Supply: +3.3V -5% to +10%.
46, 59, 110, 123	VSS	Ground	Ground: GND
13, 25, 38, 64, 77, 89, 102	VCCQ	I/O Supply	Output Buffer Supply: +2.5V or 3.3V
1, 14, 26, 39, 65, 78, 90, 103	VSSQ	I/O Ground	Output Buffer Ground: GND
40, 52	NC	-	No Connect: These signals are not internally connected.

## BURST ADDRESS TABLE (MODE = NC/VCC)

First Address (external)	Second Address (internal)	Third Address (internal)	Fourth Address (internal)
A...A00	A...A01	A...A10	A...A11
A...A01	A...A00	A...A11	A...A10
A...A10	A...A11	A...A00	A...A01
A...A11	A...A10	A...A01	A...A00

## BURST ADDRESS TABLE (MODE = GND)

First Address (external)	Second Address (internal)	Third Address (internal)	Fourth Address (internal)
A...A00	A...A01	A...A10	A...A11
A...A01	A...A10	A...A11	A...A00
A...A10	A...A11	A...A00	A...A01
A...A11	A...A00	A...A01	A...A10

## TRUTH TABLE

OPERATION	ADDRESS USED	CE#	ADSP#	ADSC#	ADV#	WRITE#	OE#	CLK	DQ
Deselected Cycle, Power Down	None	H	X	L	X	X	X	L-H	High-Z
READ Cycle, Begin Burst	External	L	L	X	X	X	L	L-H	Q
READ Cycle, Begin Burst	External	L	L	X	X	X	H	L-H	High-Z
WRITE Cycle, Begin Burst	External	L	H	L	X	L	X	L-H	D
READ Cycle, Begin Burst	External	L	H	L	X	H	L	L-H	Q
READ Cycle, Begin Burst	External	L	H	L	X	H	H	L-H	High-Z
READ Cycle, Continue Burst	Next	X	H	H	L	H	L	L-H	Q
READ Cycle, Continue Burst	Next	X	H	H	L	H	H	L-H	High-Z
READ Cycle, Continue Burst	Next	H	X	H	L	H	L	L-H	Q
READ Cycle, Continue Burst	Next	H	X	H	L	H	H	L-H	High-Z
WRITE Cycle, Continue Burst	Next	X	H	H	L	L	X	L-H	D
WRITE Cycle, Continue Burst	Next	H	X	H	L	L	X	L-H	D
READ Cycle, Suspend Burst	Current	X	H	H	H	H	L	L-H	Q
READ Cycle, Suspend Burst	Current	X	H	H	H	H	H	L-H	High-Z
READ Cycle, Suspend Burst	Current	H	X	H	H	H	L	L-H	Q
READ Cycle, Suspend Burst	Current	H	X	H	H	H	H	L-H	High-Z
WRITE Cycle, Suspend Burst	Current	X	H	H	H	L	X	L-H	D
WRITE Cycle, Suspend Burst	Current	H	X	H	H	L	X	L-H	D

- Note:
1. X means "don't care." H means logic HIGH. L means logic LOW. WRITE# = L means [BWE# + BW1#\*BW2#\*BW3#\*BW4#\*BW5#\*BW6#\*BW7#\*BW8#]\*GW# equals LOW. WRITE# = H means [BWE# + BW1#\*BW2#\*BW3#\*BW4#\*BW5#\*BW6#\*BW7#\*BW8#]\*GW# equals HIGH.
  2. BW1# enables write to DQ1-DQ8. BW2# enables write to DQ9-DQ16. BW3# enables write to DQ17-DQ24. BW4# enables write to DQ25-DQ32. BW5# enables write to DQ33-DQ40. BW6# enables write to DQ41-DQ48. BW7# enables write to DQ49-DQ56. BW8# enables write to DQ57-DQ64.
  3. All inputs except OE# must meet setup and hold times around the rising edge (LOW to HIGH) of CLK.
  4. Suspending burst generates wait cycle.
  5. For a write operation following a read operation, OE# must be HIGH before the input data required setup time plus High-Z time for OE# and staying HIGH throughout the input data hold time.
  6. This device contains circuitry that will ensure the outputs will be in High-Z during power-up.
  7. ADSP# LOW along with chip being selected always initiates an READ cycle at the L-H edge of CLK. A WRITE cycle can be performed by setting WRITE# LOW for the CLK L-H edge of the subsequent wait cycle. Refer to WRITE timing diagram for clarification.

## PARTIAL TRUTH TABLE FOR READ/WRITE

FUNCTION	GW#	BWE#	BW1#	BW2#	BW3#	BW4#	BW5#	BW6#	BW7#	BW8#
READ	H	H	X	X	X	X	X	X	X	X
READ	H	X	H	H	H	H	H	H	H	H
WRITE one byte (Byte 1)	H	L	L	H	H	H	H	H	H	H
WRITE one byte (Byte 8)	H	L	H	H	H	H	H	H	H	L
WRITE two bytes (Byte 2 & 4)	H	L	H	L	H	L	H	H	H	H
WRITE all bytes	H	L	L	L	L	L	L	L	L	L
WRITE all bytes	L	X	X	X	X	X	X	X	X	X

### ABSOLUTE MAXIMUM RATINGS\*

Voltage on VCC Supply Relative to VSS.....	-0.5V to +4.6V
V <sub>IN</sub> .....	-0.5V to +6V
Storage Temperature (plastic) .....	-55°C to +150°
Junction Temperature .....	+150°
Power Dissipation .....	1.6W
Short Circuit Output Current .....	100mA

\*Stresses greater than those listed under “Absolute Maximum Ratings” may cause permanent damage to the device. This is a stress rating only and functional operation of the device at these or any other conditions above those indicated in the operational sections of this specification is not implied. Exposure to absolute maximum rating conditions for extended periods may affect reliability.

### DC ELECTRICAL CHARACTERISTICS AND RECOMMENDED OPERATING CONDITIONS

(0°C ≤ T<sub>a</sub> ≤ 70°C; VCC = 3.3V -5 to +10% unless otherwise noted)

DESCRIPTION	CONDITIONS	SYMBOL	MIN	MAX	UNITS	NOTES
Input High (Logic 1) Voltage	Data Inputs (DQxx)	V <sub>IHD</sub>	2.0	VCCQ+0.3	V	1, 2
	All Other Inputs	V <sub>IH</sub>	2.0	4.6	V	1, 2
Input Low (Logic 0) Voltage		V <sub>IL</sub>	-0.3	0.8	V	1, 2
Input Leakage Current	0V ≤ V <sub>IN</sub> ≤ VCC	I <sub>L1</sub>	-2	2	uA	14
Output Leakage Current	Output(s) disabled, 0V ≤ V <sub>OUT</sub> ≤ VCC	I <sub>LO</sub>	-2	2	uA	
Output High Voltage	I <sub>OH</sub> = -4.0mA	V <sub>OH</sub>	2.4		V	1, 11
Output Low Voltage	I <sub>OL</sub> = 8.0mA	V <sub>OL</sub>		0.4	V	1, 11
Supply Voltage		VCC	3.1	3.6	V	1
I/O Supply Voltage		VCCQ	2.375	VCC	V	1

DESCRIPTION	CONDITIONS	SYM	TYP	-5	-6	-7	UNITS	NOTES
Power Supply Current: Operating	Device selected; all inputs ≤ V <sub>IL</sub> or ≥ V <sub>IH</sub> ; cycle time ≥ 1KC MIN; VCC = MAX; outputs open	I <sub>CC</sub>	200	320	280	240	mA	3, 12, 13
CMOS Standby	Device deselected; VCC = MAX; all inputs ≤ VSS +0.2 or ≥ VCC -0.2; all inputs static; CLK frequency = 0	I <sub>SB2</sub>	0.4	4	4	4	mA	12, 13
TTL Standby	Device deselected; all inputs ≤ V <sub>IL</sub> or ≥ V <sub>IH</sub> ; all inputs static; VCC = MAX; CLK frequency = 0	I <sub>SB3</sub>	8	18	18	18	mA	12, 13
Clock Running	Device deselected; all inputs ≤ V <sub>IL</sub> or ≥ V <sub>IH</sub> ; VCC = MAX; CLK cycle time ≥ 1KC MIN	I <sub>SB4</sub>	50	95	85	75	mA	12, 13

### CAPACITANCE

DESCRIPTION	CONDITIONS	SYMBOL	TYP	MAX	UNITS	NOTES
Input Capacitance	T <sub>A</sub> = 25°C; f = 1 MHz VCC = 3.3V	C <sub>I</sub>	3	4	pF	4
Input/Output Capacitance (DQ)		C <sub>O</sub>	6	7	pF	4

## AC ELECTRICAL CHARACTERISTICS

(Note 5) ( $0^{\circ}\text{C} \leq T_A \leq 70^{\circ}\text{C}$ ;  $V_{CC} = 3.3\text{V} -5 \text{ to } +10\%$ )

DESCRIPTION	SYM	-5*		-6		-7		UNITS	NOTES
		MIN	MAX	MIN	MAX	MIN	MAX		
<b>Clock</b>									
Clock cycle time	$t_{KC}$	10		12		15		ns	
Clock HIGH time	$t_{KH}$	4		4		5		ns	
Clock LOW time	$t_{KL}$	4		4		5		ns	
<b>Output Times</b>									
Clock to output valid	$t_{KQ}$		5		6		7	ns	
Clock to output invalid	$t_{KQX}$	2		2		2		ns	
Clock to output in Low-Z	$t_{KQLZ}$	3		3		3		ns	6,7
Clock to output in High-Z	$t_{KQHZ}$		5		5		6	ns	6,7
OE to output valid	$t_{OEQ}$		5		6		7	ns	9
OE to output in Low-Z	$t_{OELZ}$	0		0		0		ns	6,7
OE to output in High-Z	$t_{OEHZ}$		4		5		6	ns	6,7
<b>Setup Times</b>									
Address, Controls and Data In	$t_S$	2.5		2.5		2.5		ns	10
<b>Hold Times</b>									
Address, Controls and Data In	$t_H$	0.5		0.5		0.5		ns	10

## CAPACITANCE DERATING

DESCRIPTION	SYMBOL	TYP	MAX	UNITS	NOTES
Clock to output valid	$\Delta t_{KQ}$	0.016		ns / pF	15

## THERMAL CONSIDERATION

DESCRIPTION	CONDITIONS	SYMBOL	TQFP TYP	UNITS	NOTES
Thermal Resistance - Junction to Ambient	Still air, soldered on 4.25 x 1.125 inch 4-layer PCB	$\theta_{JA}$	20	$^{\circ}\text{C}/\text{W}$	
Thermal Resistance - Junction to Case		$\theta_{JC}$	1	$^{\circ}\text{C}/\text{W}$	

## AC TEST CONDITIONS

Input pulse levels	0V to 3.0V
Input rise and fall times	1.5ns
Input timing reference levels	1.5V
Output reference levels	1.5V
Output load	See Figures 1 and 2

## OUTPUT LOADS

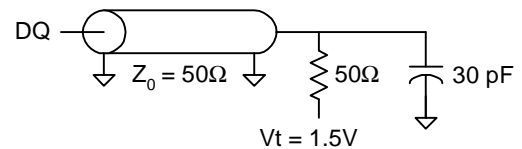

Fig. 1 OUTPUT LOAD EQUIVALENT

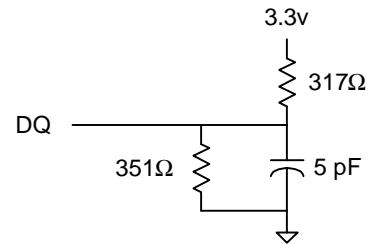

Fig. 2 OUTPUT LOAD EQUIVALENT

## NOTES

- All voltages referenced to VSS (GND).
- Overshoot:  $V_{IH} \leq +6.0V$  for  $t \leq {}^tKC / 2$ .  
Undershoot:  $V_{IL} \leq -2.0V$  for  $t \leq {}^tKC / 2$
- $I_{cc}$  is given with no output current.  $I_{cc}$  increases with greater output loading and faster cycle times.
- This parameter is sampled.
- Test conditions as specified with the output loading as shown in Fig. 1 unless otherwise noted.
- Output loading is specified with  $CL=5pF$  as in Fig. 2.
- At any given temperature and voltage condition,  ${}^tKQHZ$  is less than  ${}^tKQLZ$  and  ${}^tOEHZ$  is less than  ${}^tOELZ$ .
- A READ cycle is defined by byte write enables all HIGH or ADSP# LOW along with chip enables being active for the required setup and hold times. A WRITE cycle is defined by at one byte or all byte WRITE per READ/WRITE TRUTH TABLE.
- OE# is a "don't care" when a byte write enable is sampled LOW.
- This is a synchronous device. All synchronous inputs must meet specified setup and hold time, except for "don't care" as defined in the truth table.
- AC I/O curves are available upon request.
- "Device Deselected" means the device is in POWER -DOWN mode as defined in the truth table. "Device Selected" means the device is active.
- Typical values are measured at 3.3V, 25°C and 20ns cycle time.
- MODE pin has an internal pull-up and ZZ pin has an internal pull-down. These two pins exhibit an input leakage current of  $\pm 30 \mu A$ .
- Capacitance derating applies to capacitance different from the load capacitance shown in Fig. 1.



## READ TIMING

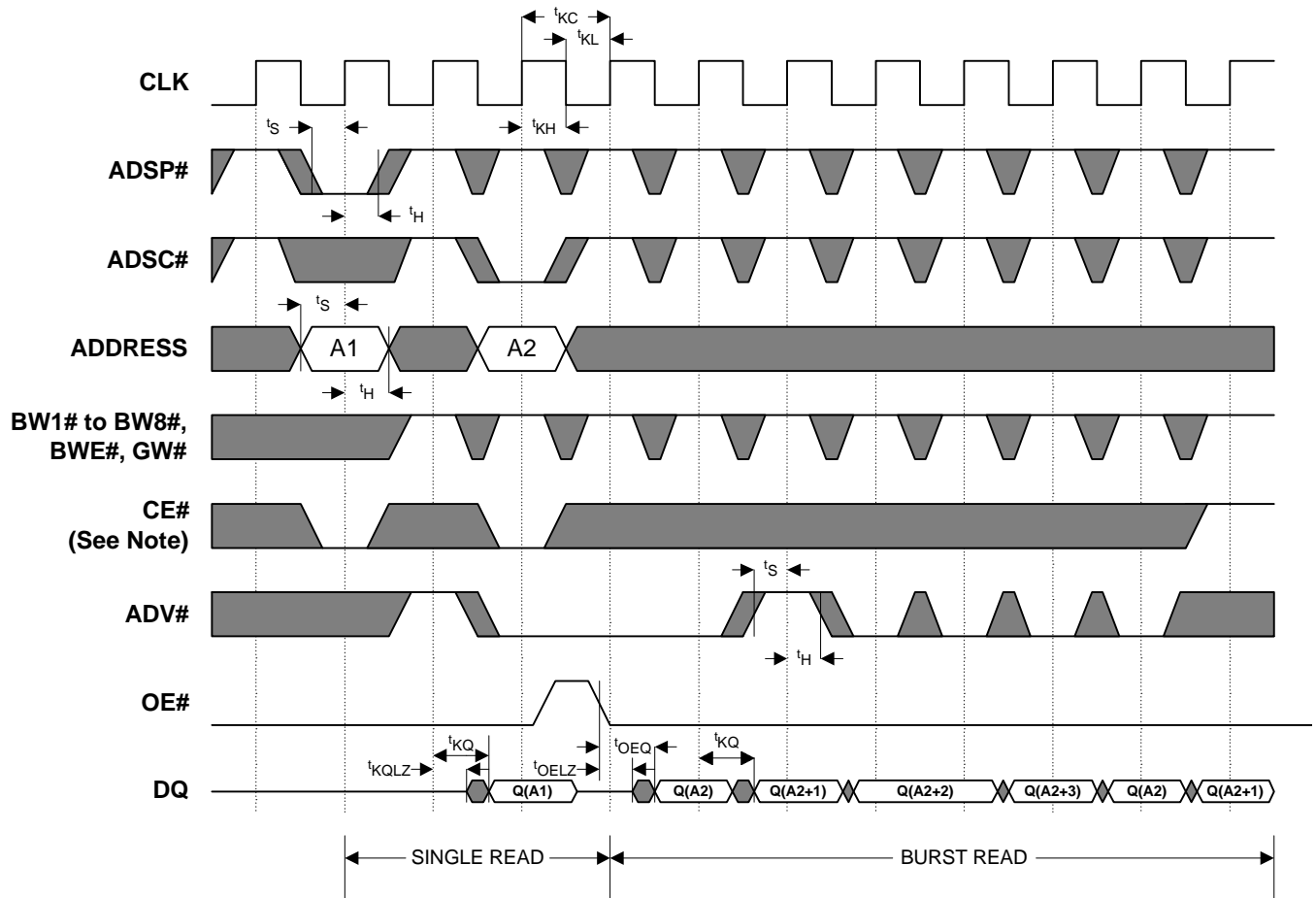

Note: CE# active in this timing diagram means that all chip enables CE#, CE2#, CE3#, CE2, and CE3 are active.

**WRITE TIMING**

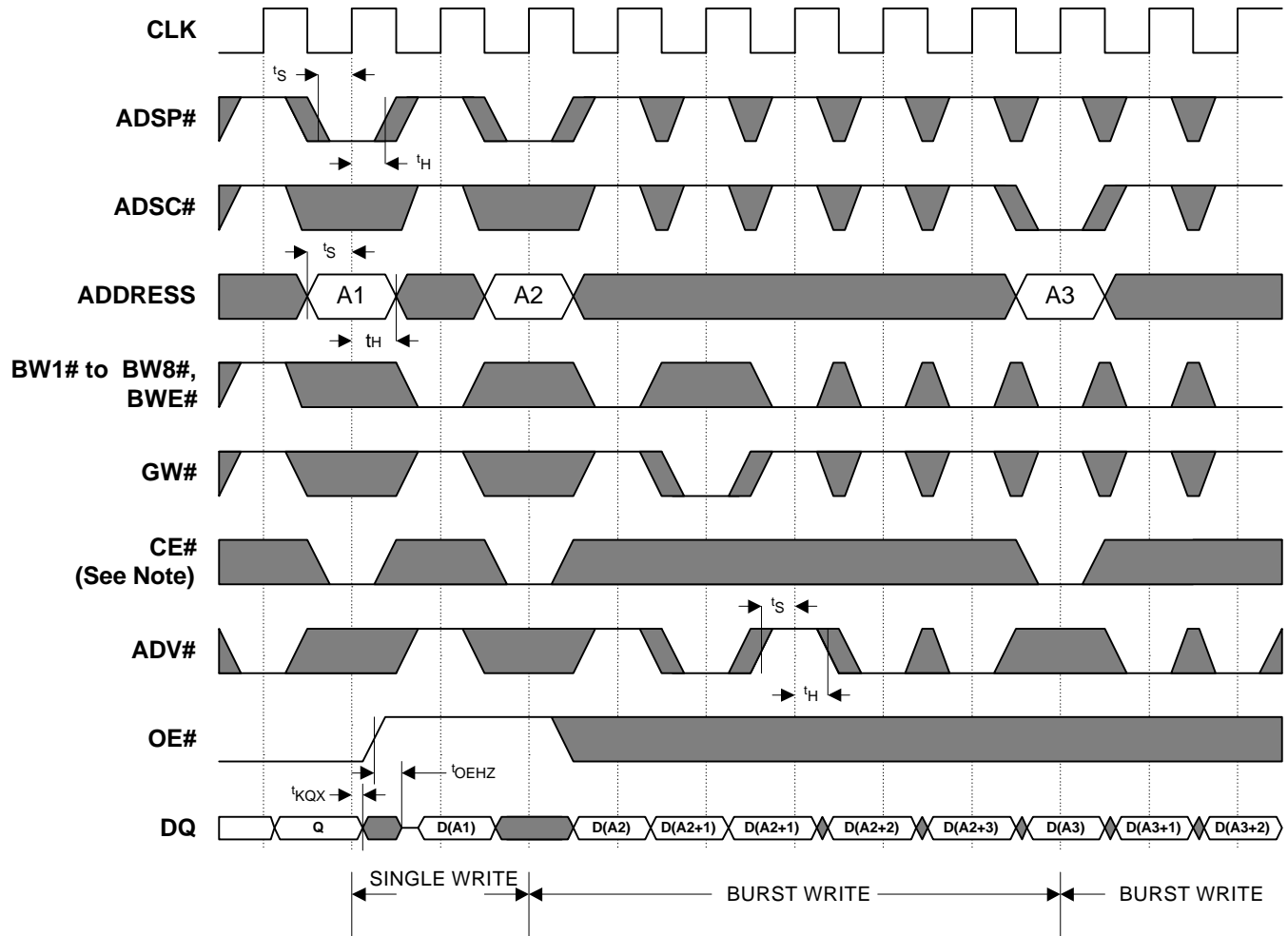

Note: CE# active in this timing diagram means that all chip enables CE#, CE2#, CE3#, CE2, and CE3 are active.

**READ/WRITE TIMING**

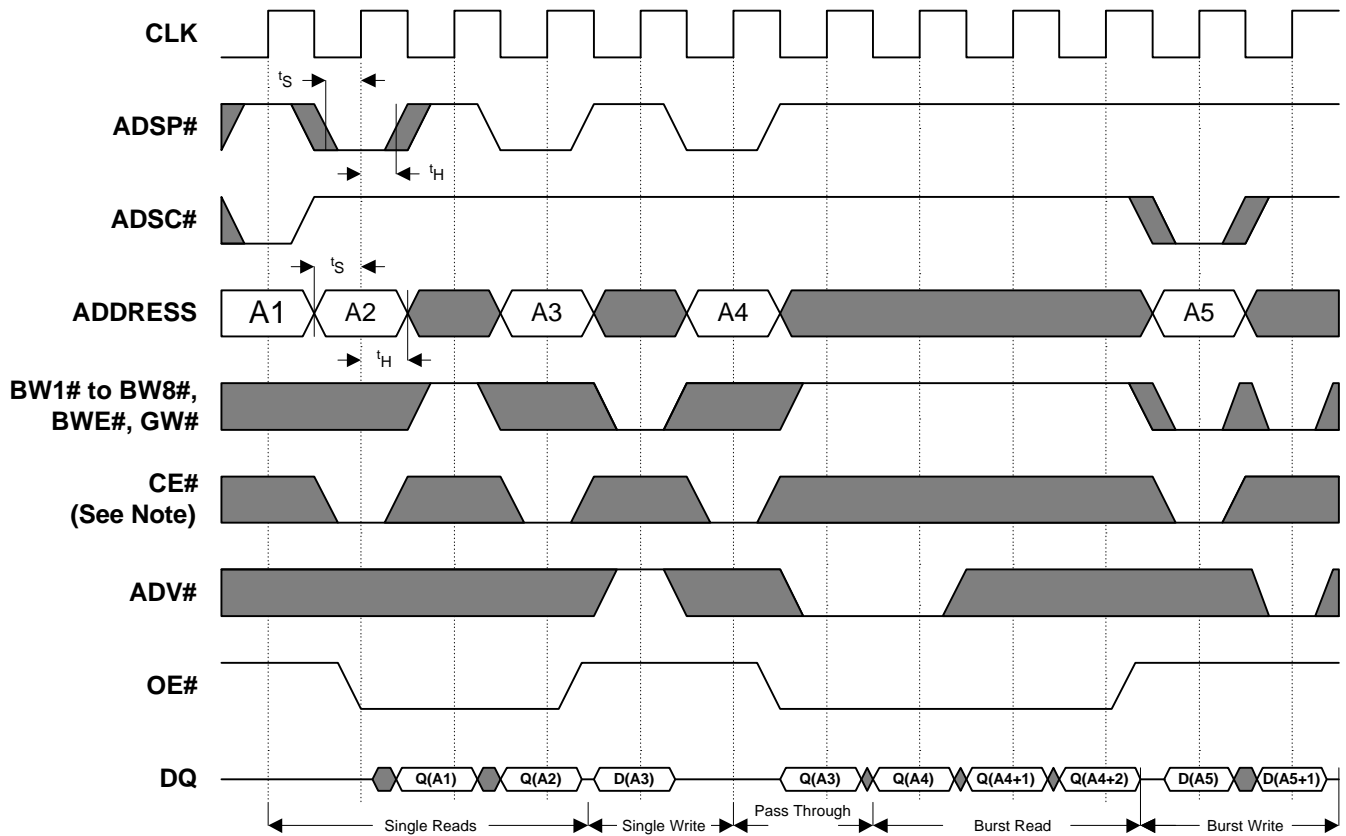

Note: CE# active in this timing diagram means that all chip enables CE#, CE2#, CE3#, CE2, and CE3 are active.

## 100 Pin PQFP, 128 Pin PQFP, and 128 Pin TQFP Package Dimension

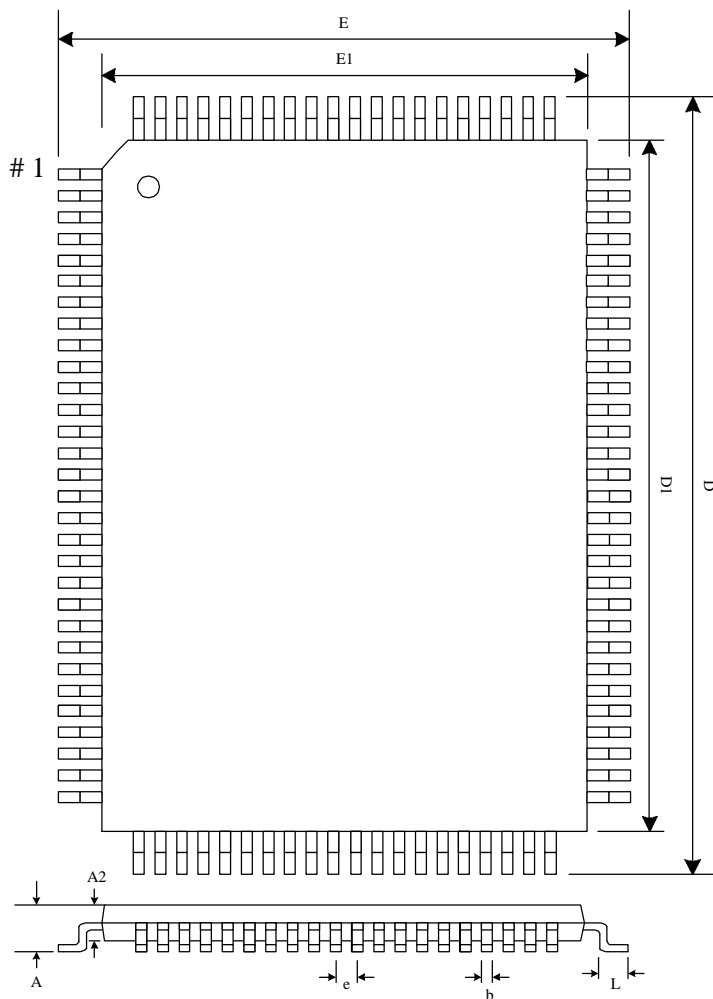

Package	PQFP			TQFP		
No. of Leads	128			128		
Symbol	MIN	NOM	MAX	MIN	NOM	MAX
D	22.90	23.20	23.50	21.90	22.00	22.10
D1	19.90	20.00	20.10	19.90	20.00	20.10
E	16.90	17.20	17.50	15.90	16.00	16.10
E1	13.90	14.00	14.10	13.90	14.00	14.10
A	2.80	3.10	3.40	1.40	1.50	1.60
A2	2.55	2.80	3.05	1.35	1.40	1.45
L	0.73	0.88	1.03	0.45	0.60	0.75
b	0.17	0.20	0.27	0.17	0.20	0.27
e	0.50 Basic			0.50 Basic		

Note: All dimensions are in Millimeters.

## Ordering Information

### GVT 7164D64 X - X

Galvantech Prefix

Part Number

Speed (5 = 5ns access/10ns cycle  
6 = 6ns access/12ns cycle  
7 = 7ns access/15ns cycle)

Package (Q = 128 PIN PQFP,  
T = 128 PIN TQFP)