

M5294P

SYSTEM RESET IC WITH LOW INPUT-OUTPUT VOLTAGE DIFFERENTIAL TYPE $\pm 5V$ REGULATOR, AND 3.0V REGULATOR FOR MUTE FUNCTION

DESCRIPTION

M5294P is a semiconductor integrated circuit designed for dual tracking type voltage regulator, which includes system reset circuit, and 3.0V regulator for mute function.

Since the output voltage ($\pm 5V$, 3V) are fixed inside, and this IC includes pull-up resistor ($10k\Omega$) of reset output, User can omit the outside parts. $\pm 5V$ output is low power dissipation type, that is to say, this is able to operate even if input-output voltage difference is very low status such as 0.2V ($@I_O = \pm 100mA$). Therefore, User can shrink the input transformer.

User can prevent making a noise by means of operating mute function before Power supply ($\pm 5V$) of Amplifier starts up, for 3.0V regulator for mute function starts up earlier than $\pm 5V$ output.

FEATURES

- Fixed output voltage
- Power supply for mute function
- Very low input-output voltage differential operation
- Current limiting circuit
 - $\pm 5V$ output short circuit protection with current fold back
 - mute output short circuit protection
- Thermal protection circuit
- Capable on/off control (11-pin terminal)
- Internal system reset circuit with pull-up resistor, hysteresis detectable voltage 3.9V (delay time is variable by connecting capacity at 7-pin terminal)

APPLICATION

CD, VCR and dual power supply power system

PIN CONFIGURATION (TOP VIEW)

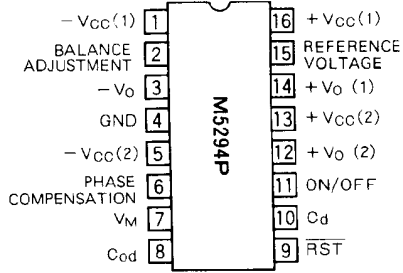

Outline 16P4

- Note 1: Please use the capacitor not to depend on the ambient temperature.
 Note 2: Please connect $-V_{CC}(1)$ and $-V_{CC}(2)$, $+V_{CC}(1)$ and $+V_{CC}(2)$, $+V_O(1)$ and $+V_O(2)$, firmly each other.

EQUIVALENT CIRCUIT DIAGRAM

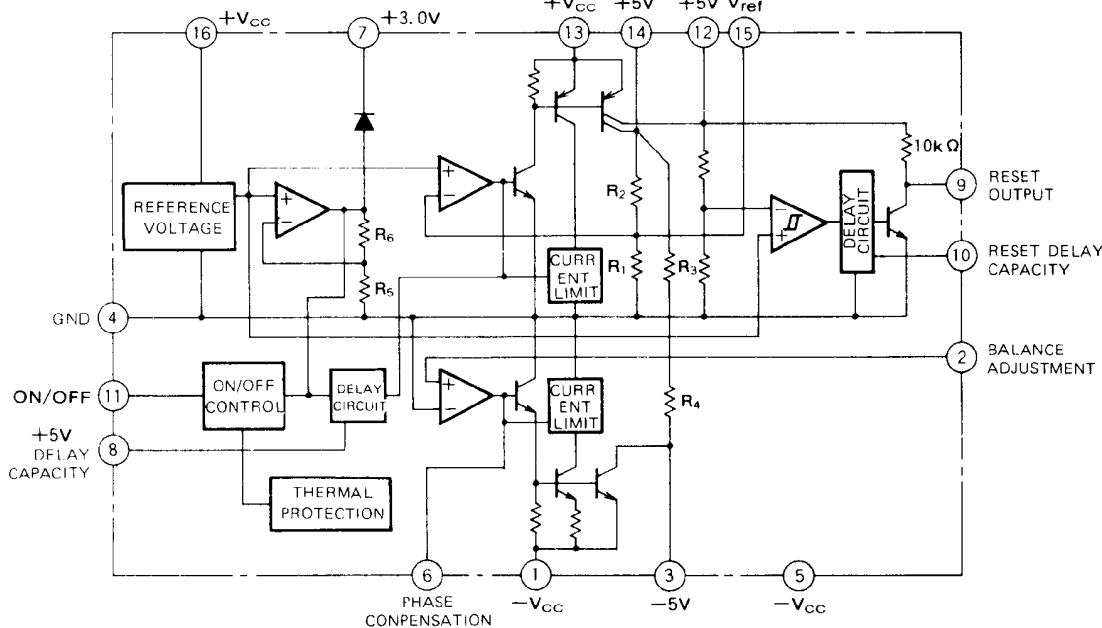

**SYSTEM RESET IC WITH LOW INPUT-OUTPUT VOLTAGE DIFFERENTIAL
TYPE ±5V REGULATOR, AND 3.0V REGULATOR FOR MUTE FUNCTION**

ABSOLUTE MAXIMUM RATINGS (Ta = 25 °C, unless otherwise noted)

| Symbol | Parameter | Conditions | Ratings | Unit |
|------------------|---------------------------------|------------|---|-------|
| V _{CC} | Supply voltage | | ± 15 (30) | V |
| I _{LP⊕} | Positive load current | | + 200 | mA |
| I _{LP⊖} | Negative load current | | - 200 | mA |
| I _{LPM} | Mute regulator load current | | 10 | mA |
| V _{DIF} | Input/Output voltage difference | | ± 10 | V |
| P _d | Power dissipation | | 1.0 without sheet for setting free fever | W |
| K _θ | Thermal derating | Ta ≥ 25 °C | 10.0 without sheet for setting free fever | mW/°C |
| T _{opr} | Ambient temperature | | - 20 ~ + 75 | °C |
| T _{stg} | Storage temperature | | - 55 ~ + 125 | °C |

THERMAL DELATING

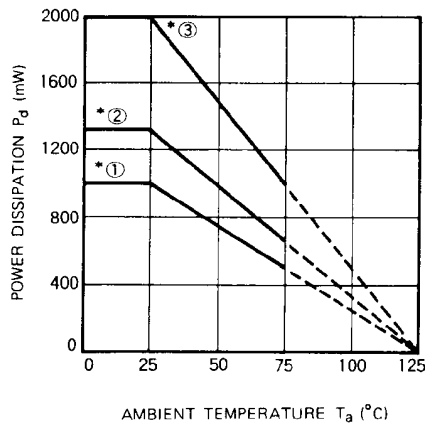

*① Condition as follow

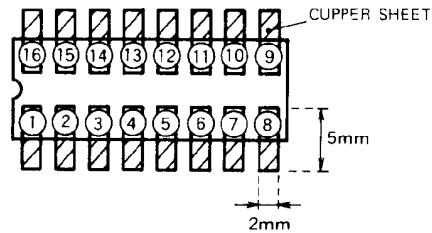

*② Condition as follow

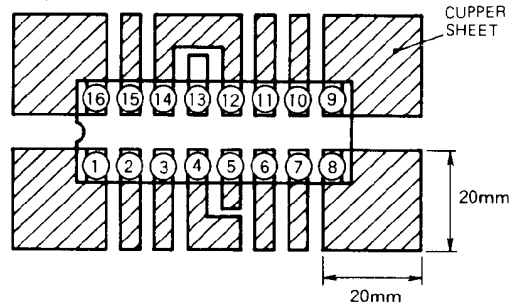

*③ Allowable Power dissipation in setting free fever infinitely

When the Power loss in the IC is large, please design for setting free fever not to be 125 °C at junction.

**SYSTEM RESET IC WITH LOW INPUT-OUTPUT VOLTAGE DIFFERENTIAL
TYPE $\pm 5V$ REGULATOR, AND 3.0V REGULATOR FOR MUTE FUNCTION****ELECTRICAL CHARACTERISTICS** ($V_{IN} = \pm 7V$, $I_{O+} = 100mA$, $I_{O-} = -100mA$, $T_a = 25^\circ C$)

| Symbol | Parameter | Test conditions | Limits | | | Unit |
|--------------|--------------------------|-------------------|--------|------|------|------|
| | | | Min | Typ | Max | |
| I_{CC+} | Positive circuit current | without load | — | 6 | 10 | mA |
| I_{CC-} | Negative circuit current | without load | — | -1.5 | -5.0 | mA |
| I_{LOSS+1} | Loss current | $I_{O+} = 100mA$ | — | 10 | 30 | mA |
| I_{LOSS+2} | | $I_{O+} = 200mA$ | — | 30 | 90 | mA |
| I_{LOSS-1} | | $I_{O-} = -100mA$ | — | -2 | -20 | mA |
| I_{LOSS-2} | | $I_{O-} = -200mA$ | — | -5 | -40 | mA |

REGULATOR PART

| Symbol | Parameter | Test conditions | Limits | | | Unit |
|---------------------------|-----------------------------------|--|------------|-----------|------------|---------------|
| | | | Min | Typ | Max | |
| V_O | Output voltage | | ± 4.75 | ± 5.0 | ± 5.25 | V |
| REG-in | Input voltage rejection | $V_{CC} \pm 6 - \pm 10V$ | — | 0.05 | 0.2 | %/V |
| REG-o | Loading voltage rejection | $I_O = 1 - 100mA$ | — | 20 | 100 | mV |
| R.R(+) | Positive ripple rejection | $C_{REF} = 1\mu F$, $f = 120Hz$ | 60 | 85 | — | dB |
| R.R(-) | Negative ripple rejection | $C_{REF} = 1\mu F$, $f = 120Hz$ | 50 | 60 | — | dB |
| $\Delta V(\oplus\ominus)$ | Dual voltage tracking | | — | 0.5 | 5 | % |
| V_{NO} | Output noise voltage | $f = 20Hz - 100kHz$ | — | 20 | — | μV_{rms} |
| $V_{O(cut)}$ | Output cut-off voltage | $0V \leq \text{pin voltage} \leq 0.2V$ | — | — | 0.1 | V |
| V_{ref} | Reference input voltage | | 1.13 | 1.24 | 1.36 | V |
| V_{DIF+} | Input-Output voltage differential | $I_{O+} = 100mA$ | — | 0.2 | 0.5 | V |
| V_{DIF-} | Input-Output voltage differential | $I_{O-} = -100mA$ | — | 0.2 | 0.5 | V |
| T_{od} | Output delay time *1 | $C_{od} = 0.1\mu F$ | 4.5 | 9 | 18 | mS |
| I_{OS+} | Output short current | $T_j = 125^\circ C$ | — | 30 | — | mA |
| I_{OS-} | | $T_j = 125^\circ C$ | — | 30 | — | mA |

MUTE REGULATOR PART

| Symbol | Parameter | Test conditions | Limits | | | Unit |
|------------|---------------------------------|-----------------|--------|-----|-----|------|
| | | | Min | Typ | Max | |
| V_M | Mute output voltage | $I_{LM} = 3mA$ | 2.7 | 3.0 | 3.3 | V |
| V_{DIFM} | Input/Output voltage difference | $I_{LM} = 3mA$ | — | 2.5 | 3.2 | V |

RESET PART

| Symbol | Parameter | Test conditions | Limits | | | Unit |
|--------------|---------------------------|-------------------|--------|-----|------|------|
| | | | Min | Typ | Max | |
| V_S | Detected voltage | | 3.70 | 3.9 | 4.10 | V |
| ΔV_S | Hysteresis voltage | | 50 | 100 | 200 | mV |
| T_{pd} | Delay time *2 | $C_d = 0.1\mu F$ | 5.5 | 11 | 22 | mS |
| V_{sat} | Output saturation voltage | $R_L = 10k\Omega$ | — | 0.2 | 0.4 | V |

*1. The period by when +5V output starts up since MUTE Reg. rises up to 1.5V.

*2. Reset output includes resistor (10k Ω) from the +5V output, but output saturation voltage is condition with outside resistor (10k Ω).

**SYSTEM RESET IC WITH LOW INPUT-OUTPUT VOLTAGE DIFFERENTIAL
TYPE $\pm 5V$ REGULATOR, AND 3.0V REGULATOR FOR MUTE FUNCTION**

TYPICAL CHARACTERISTICS

CIRCUIT CURRENT VS. POWER SUPPLY

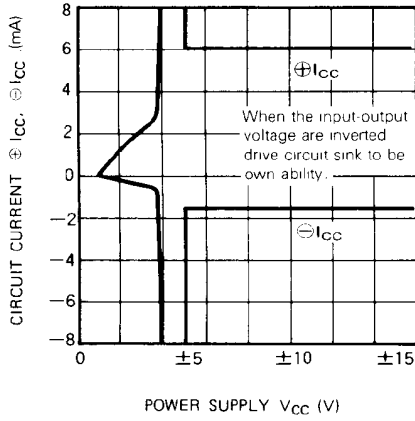

CIRCUIT CURRENT VS. AMBIENT TEMPERATURE

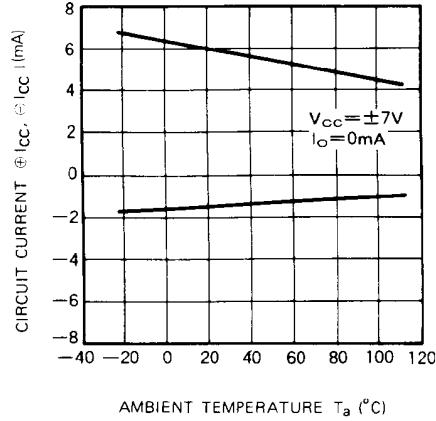

OUTPUT VOLTAGE VS. POWER SUPPLY

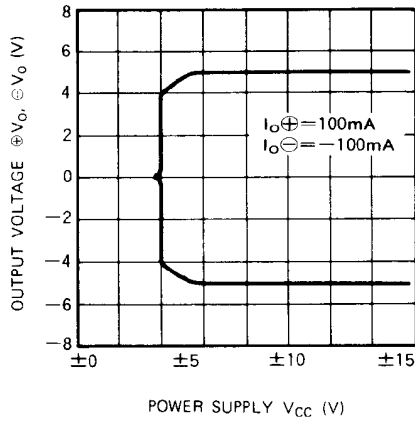

OUTPUT VOLTAGE VS. AMBIENT TEMPERATURE

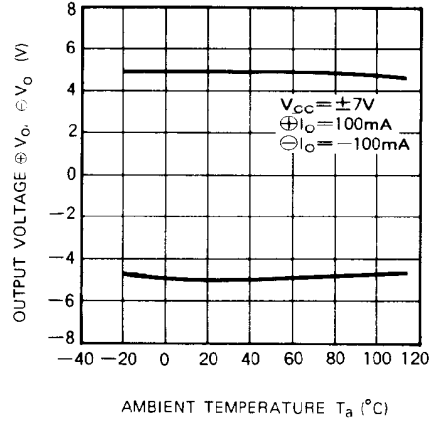

OUTPUT SHORT CURRENT VS. JUNCTION TEMPERATURE

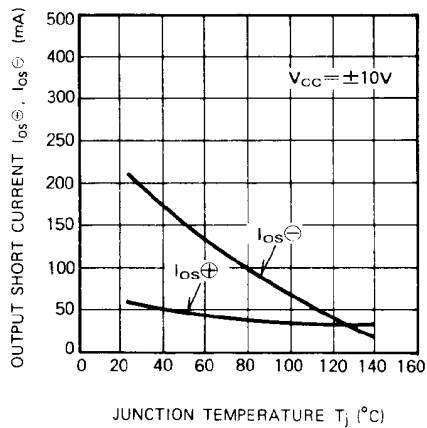

RIPPLE REJECTION VS. FREQUENCY

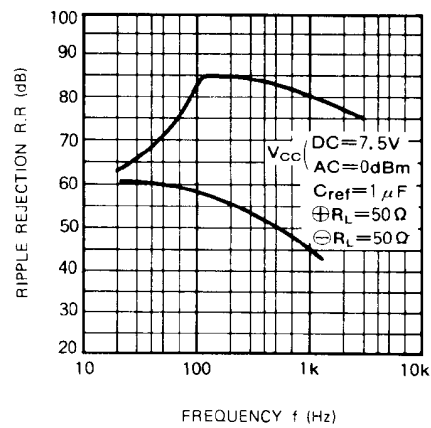

**SYSTEM RESET IC WITH LOW INPUT-OUTPUT VOLTAGE DIFFERENTIAL
TYPE $\pm 5V$ REGULATOR, AND 3.0V REGULATOR FOR MUTE FUNCTION**

MUTE VOLTAGE VS. POWER SUPPLY

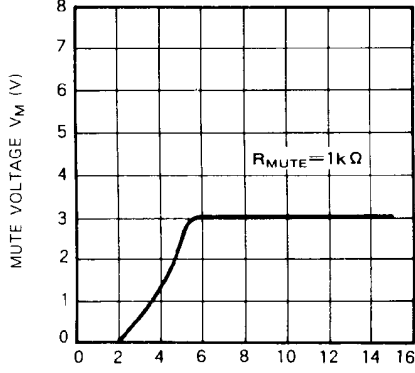

POSITIVE POWER SUPPLY $+V_{CC}$ (V)

**RESET OUTPUT SATURATION VOLTAGE
VS. AMBIENT TEMPERATURE**

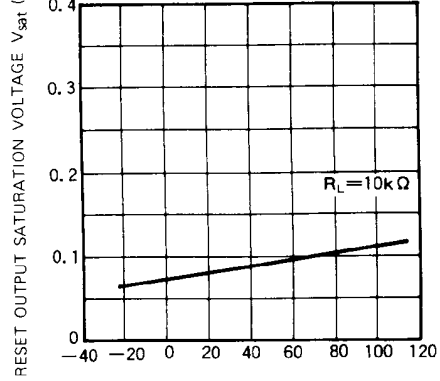

AMBIENT TEMPERATURE T_a ($^{\circ}C$)

**RESET OUTPUT SATURATION VOLTAGE
VS. RESET OUTPUT REJECTION**

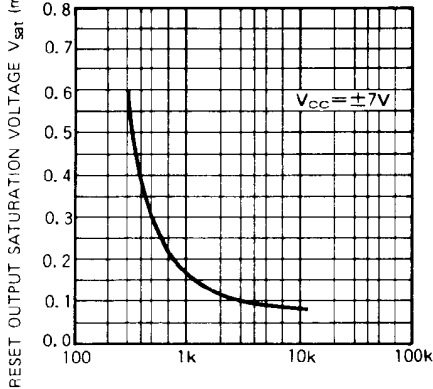

RESET OUTPUT REJECTION R_L ($k\Omega$)

DELAY TIME VS. DELAY CAPACITY

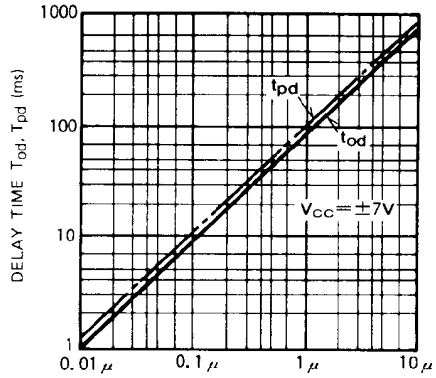

DELAY CAPACITY C_{pd}, C_d (F)

SYSTEM RESET IC WITH LOW INPUT-OUTPUT VOLTAGE DIFFERENTIAL TYPE ±5V REGULATOR, AND 3.0V REGULATOR FOR MUTE FUNCTION

OUTPUT TIMING CHART

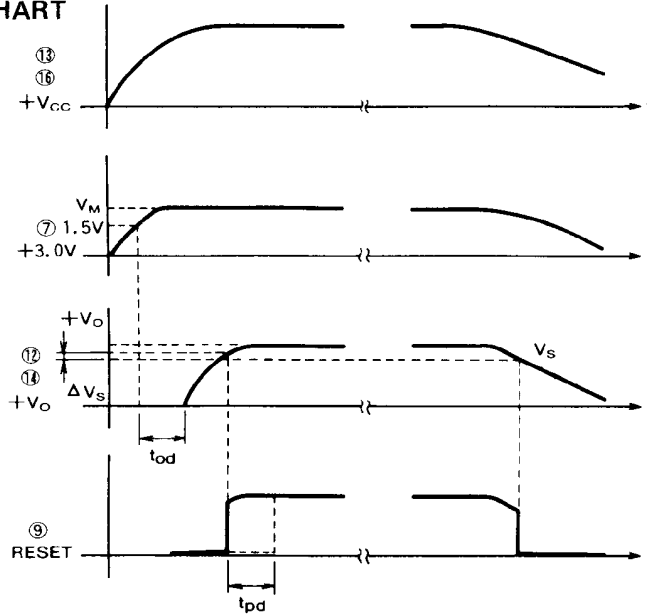

OPERATING EXPLANATION

- ① M5294P amplifies the stable reference voltage, and it makes Mute voltage V_M (3.0V) and Positive output voltage +V_O (5.0V).

$$V_M = V_{ref} \times \left(1 + \frac{R_6}{R_5}\right) - V_F$$

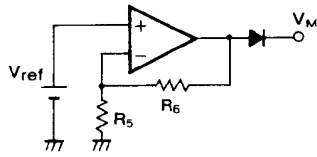

$$+V_O = V_{ref} \times \left(1 + \frac{R_2}{R_1}\right)$$

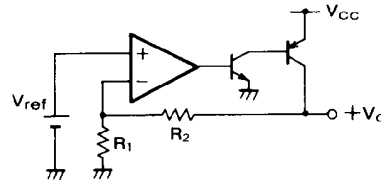

+V_O is inverted by this IC, and makes -V_O. (Therefore, -V_O depend on +V_O)

$$-V_O = -\frac{R_4}{R_3} \times V_O$$

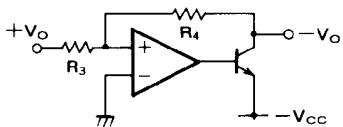

Each ±V_O includes the short-circuit protection with current foldback.
 ±V_M includes the short-circuit protection without current foldback.

- ② +V_O (±5V) output rise up since V_M (1.5V) rises up to 1.5V.
 +V_O output delay time T_{od} is set by adding external capacitor C_{od}.
 $T_{od} = 9 \times 10^4 \times C_{od} \text{ (s)}$
- ③ Low Reset output is cancelled when +V_O output rises up to V_S + ΔV_S (4.0VTYP). The delay time T_{od} is set by adding external capacitor C_d.
 $T_{pd} = 11 \times 10^4 \times C_d \text{ (s)}$
- ④ V_M is composed through the diode, therefore the transient time rises varies by external capacity and load condition. Consequently, ±V_O had been down, and if your system needs MUTE voltage, you have to increase the external capacity.
- ⑤ The Reset output is low when the +V_O is down to V_S (3.9V).

SYSTEM RESET IC WITH LOW INPUT-OUTPUT VOLTAGE DIFFERENTIAL TYPE $\pm 5V$ REGULATOR, AND 3.0V REGULATOR FOR MUTE FUNCTION

TYPICAL APPLICATION

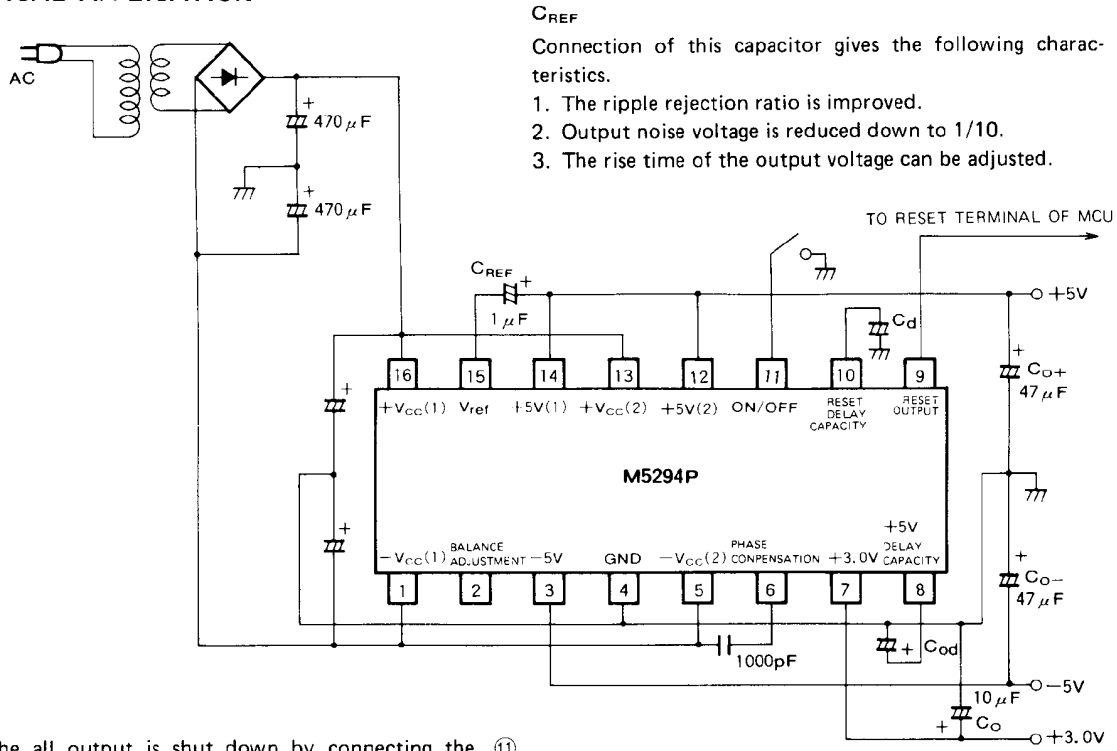

C_{REF}

Connection of this capacitor gives the following characteristics.

1. The ripple rejection ratio is improved.
2. Output noise voltage is reduced down to 1/10.
3. The rise time of the output voltage can be adjusted.

The all output is shut down by connecting the ⑪ terminal to GND level ($0 \leq V_{⑪} \leq 0.2V$).

When $-V_O$ is shorted to GND, $-V_O$ sometimes causes OSC condition, therefore please add the capacitor between ⑥ and ⑤ terminal. The capacity is about 1000pF.

1. In adjusting the output voltage (use ⑮ pin)

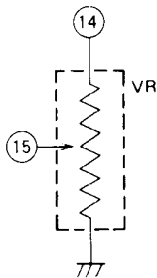

M5294P is fixed the output voltage by inside resistors, but user can adjust it by using the outside resistor.
(inside resistor: $1.6K\Omega$ ⑮ to ④ $4.85K\Omega$ ⑭ to ⑮)

2. In adjusting the tracking voltage (user ② pin)

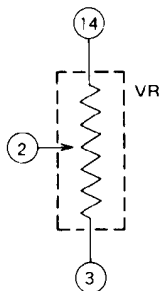

M5294P is fixed the tracking voltage by inside resistor, but user can adjust it by using the output resistor.
(inside resistor: ⑭ to ② ② to ③, $5K\Omega$)