

HA1630S07

Single CMOS High Drive Operational Amplifier

REJ03D0907-0100

Rev.1.00

Feb 22, 2008

Description

HA1630S07 is a low power single CMOS operational amplifier featuring high output current with typical current supply of 60 μ A (2.7 V to 5.5 V). This IC designed to operate from a single power supply and have full swing outputs. Available in CMPAK-5 and MPAK-5 package, the miniature size of this IC not only allows compact integration in portable devices but also minimizes distance of signal sources (sensors), thus reducing external noise pick up prior to amplification. This IC exhibit excellent current drive-power ratio capable of 2 k Ω load driving and yet resistant to oscillation for capacitive loads up to 200 pF.

Features

- Low supply current $I_{DD} = 60 \mu\text{A Typ (}V_{DD} = 3 \text{ V, }R_L = \text{No load)}$
- Low voltage operation $V_{DD} = 2.7 \text{ V to } 5.5 \text{ V}$
- Low input offset voltage $V_{IO} = 6 \text{ mV Max}$
- Low input bias current $I_{IB} = 1 \text{ pA Typ}$
- High output current $I_{OSOURCE} = 15 \text{ mA Typ (}V_{DD} = 3.0 \text{ V, }V_{OH} = 2.5 \text{ V)}$
 $I_{OSINK} = 15 \text{ mA Typ (}V_{DD} = 3.0 \text{ V, }V_{OL} = 0.5 \text{ V)}$
- Input common voltage range includes ground

Ordering Information

Part No.	Package Name	Package Code
HA1630S07CM	CMPAK-5	PTSP0005ZC-A
HA1630S07LP	MPAK-5	PLSP0005ZB-A

Pin Arrangement

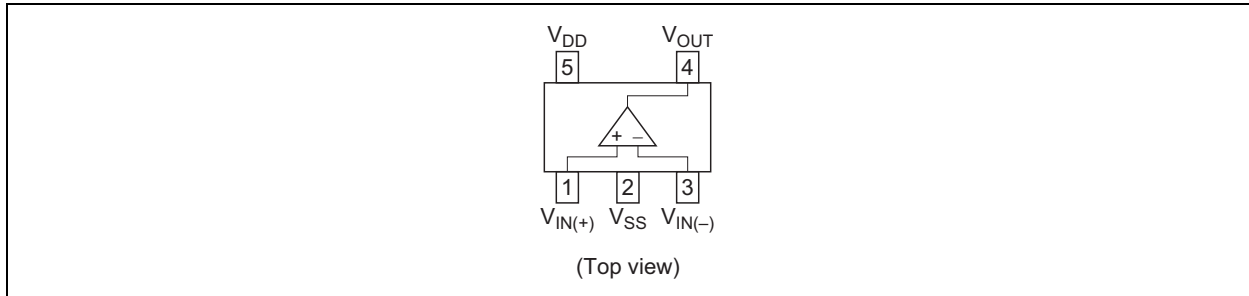

Equivalent Circuit

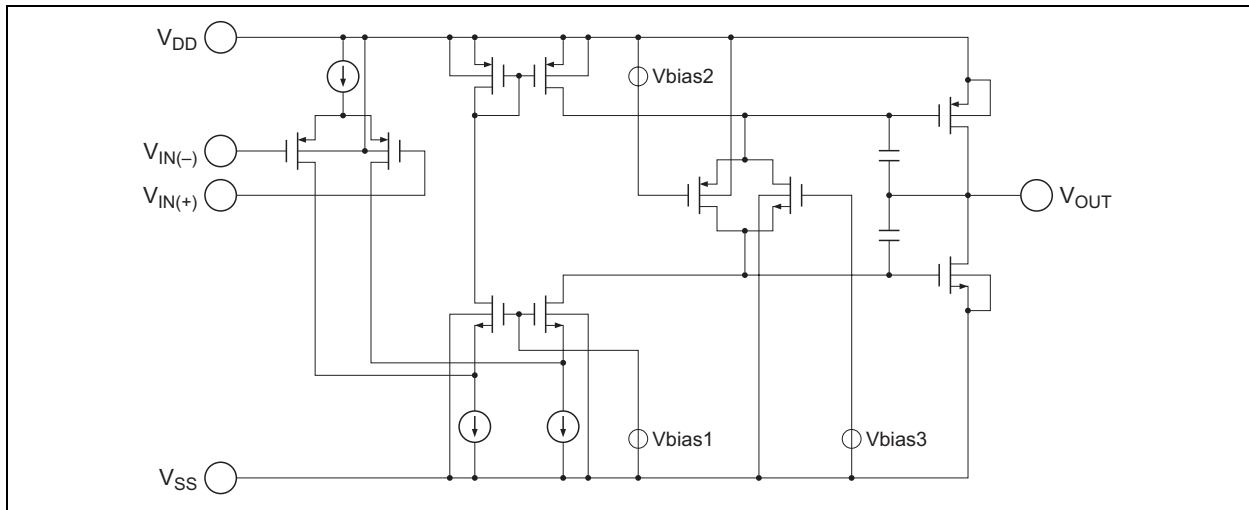

Absolute Maximum Ratings

(Ta = 25°C)

Item	Symbol	Ratings	Unit	Note
Supply voltage	V _{DD}	7.0	V	
Differential input voltage	V _{IN(diff)}	-V _{DD} to +V _{DD}	V	1
Input voltage	V _{IN}	-0.1 to +V _{DD}	V	
Output current	I _{OUT}	40	mA	
Power dissipation	P _T	80 (CMPAK-5)	mW	2
		120 (MPAK-5)		
Operating temperature	T _{opr}	-40 to +85	°C	
Storage temperature	T _{stg}	-55 to +125	°C	

Note: 1. Do not apply input voltage exceeding V_{DD} or 7 V.

2. If Ta > 25°C,

CMPAK-5: -0.8 mW/°C

MPAK-5: -1.2 mW/°C

Electrical Characteristics

DC Characteristics

(Ta = 25°C, V_{DD} = 3.0 V, V_{SS} = 0 V)

Item	Symbol	Min	Typ	Max	Unit	Test Conditions
Input offset voltage	V _{IO}	—	—	6	mV	V _{IN} = 1.5 V, R _L = 1 MΩ
Input bias current	I _{IB}	—	(1)	—	pA	V _{IN} = 1.5 V
Input offset current	I _{IO}	—	(1)	—	pA	V _{IN} = 1.5 V
Common mode input voltage range	V _{CM}	-0.1	—	1.8	V	
Supply current	I _{DD}	—	60	170	μA	V _{IN(+)} = 1.0 V, R _L = ∞
Output source current	I _{OSOURCE}	7.5	15	—	mA	V _{OUT} = 2.5 V
Output sink current	I _{OSINK}	7.5	15	—	mA	V _{OUT} = 0.5 V
Open loop voltage gain	A _V	55	80	—	dB	R _L = 100 kΩ
Common mode rejection ratio	CMRR	50	80	—	dB	V _{IN1} = 0 V, V _{IN2} = 1.8 V
Power supply rejection ratio	PSRR	55	80	—	dB	V _{DD1} = 2.7 V, V _{DD2} = 5.5 V
Output high voltage	V _{OH}	2.9	—	—	V	R _L = 2 kΩ to V _{SS}
Output low voltage	V _{OL}	—	—	0.1	V	R _L = 2 kΩ to V _{DD}

Note: () : Design specification

AC Characteristics

(Ta = 25°C, V_{DD} = 3.0 V, V_{SS} = 0 V)

Item	Symbol	Min	Typ	Max	Unit	Test Conditions
Slew rate	SRr	—	(1)	—	V/μs	V _{IN} = 1.5 V, C _L = 15 pF (V _{INL} = 0.2 V, V _{INH} = 1.7 V)
	SRf	—	(1)	—		
Gain bandwidth product	GBW	—	(1.5)	—	MHz	V _{IN} = 1.5 V, C _L = 15 pF

Note: () : Design specification

Table of Graphs

Electrical Characteristics			Characteristic Curves	Test Circuit No.
Supply current	I_{DD}	vs. Supply voltage	1	1
		vs. Temperature	2	1
Output high voltage	V_{OH}	vs. Rload	3	2
Output low voltage	V_{OL}	vs. Rload	4	3
Output source current	$I_{OSOURCE}$	vs. Output high voltage	5	4
		vs. Temperature	6	4
Output sink current	I_{OSINK}	vs. Output low voltage	7	5
		vs. Temperature	8	5
Input offset voltage	V_{IO}	vs. Supply voltage	9	6
		vs. Input voltage	10	6
		vs. Temperature	11	7
Common mode input voltage range	V_{CM}	vs. Supply voltage	12	8
		vs. Temperature	13	8
Common mode rejection ratio	CMRR	vs. Input voltage	14	9
Power supply rejection ratio	PSRR	vs. Supply voltage	15	10
Input bias current	I_{IB}	vs. Input voltage	16	11, 12
		vs. Temperature	17	11, 12
Slew rate (rising)	SRr	vs. Cload	18	13
		vs. Temperature	19	13
		Time waveform	20	13
Slew rate (falling)	SRf	vs. Cload	21	13
		vs. Temperature	22	13
		Time waveform	23	13
Open loop gain	A_V	vs. Rload	24	14
		vs. Frequency	25, 26	14
Phase margin	PM	vs. Cload	27	14
Noise input voltage	VNI	vs. Frequency	28	15

Test Circuits

(Unless otherwise noted, $V_{DD} = 3\text{ V}$, $V_{SS} = 0\text{ V}$, $T_a = 25^\circ\text{C}$)

1. Supply Current, I_{DD}

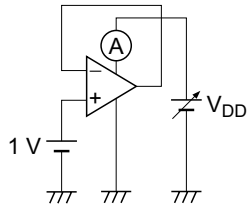

2. Output High Voltage, V_{OH}

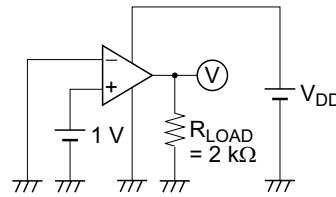

3. Output Low Voltage, V_{OL}

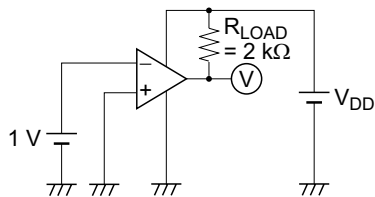

4. Output Source Current, $I_{OSOURCE}$

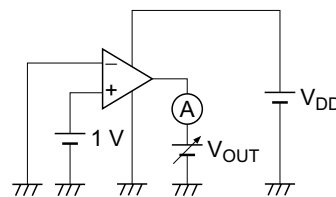

5. Output Sink Current, I_{OSINK}

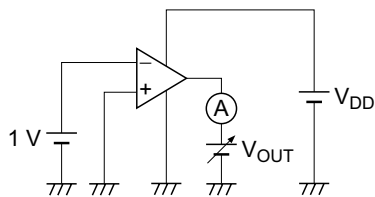

6. Input Offset Voltage vs. Operating Voltage

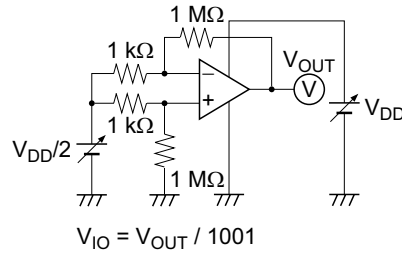

7. Input Offset Voltage, V_{IO}

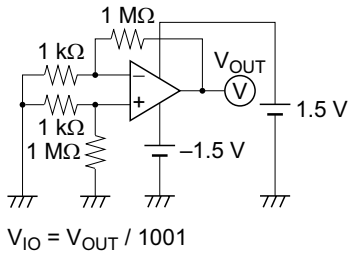

8. Common Mode Input Voltage Range, V_{CM}

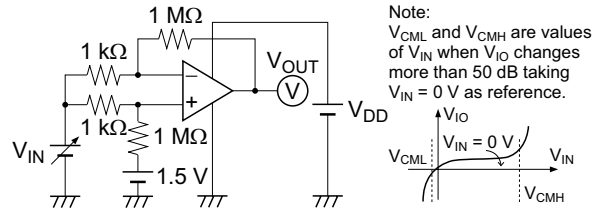

Test Circuits (cont.)

(Unless otherwise noted, $V_{DD} = 3\text{ V}$, $V_{SS} = 0\text{ V}$, $T_a = 25^\circ\text{C}$)

9. Common Mode Rejection Ratio, CMRR

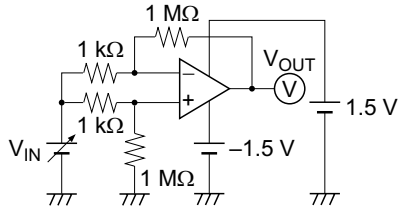

V_{IN}	Measure Point	Calculate V_{IO}	CMRR Calculation
-1.5 V	V_{OUT1}	$V_{IO1} = V_{OUT1} / 1001$	$\text{CMRR} = \left 20 \log_{10} \frac{ V_{IO2} - V_{IO1} }{0.3 - (-1.5\text{ V})} \right $
0.3 V	V_{OUT2}	$V_{IO2} = V_{OUT2} / 1001$	

10. Power Supply Rejection Ratio, PSRR

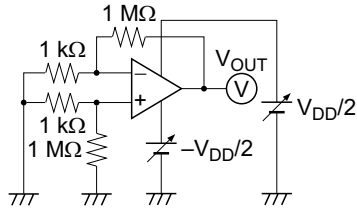

V_{DD}	Measure Point	Calculate V_{IO}	CMRR Calculation
2.7 V	V_{OUT1}	$V_{IO1} = V_{OUT1} / 1001$	$\text{PSRR} = \left 20 \log_{10} \frac{ V_{IO2} - V_{IO1} }{5.5\text{ V} - 2.7\text{ V}} \right $
5.5 V	V_{OUT2}	$V_{IO2} = V_{OUT2} / 1001$	

11. Input Bias Current, I_{B+}

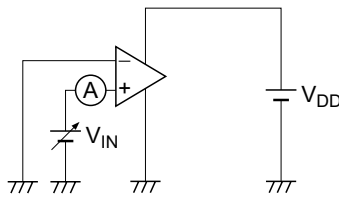

12. Input Bias Current, I_{B-}

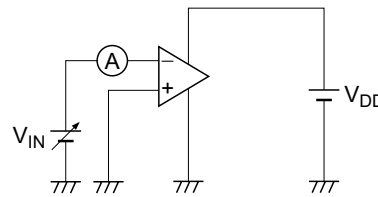

13. Slew Rate (Large Signal Input)

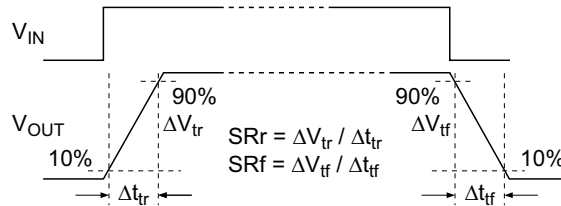
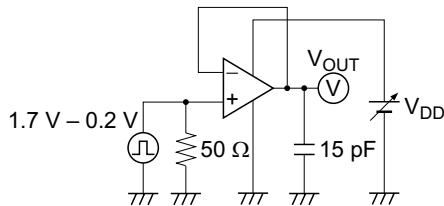

Test Circuits (cont.)

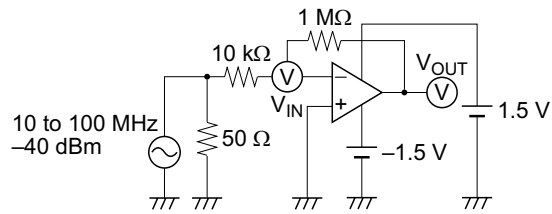
(Unless otherwise noted, $V_{DD} = 3\text{ V}$, $V_{SS} = 0\text{ V}$, $T_a = 25^\circ\text{C}$)14. Open Loop Voltage Gain, A_V 

$$A_V = \left| 20 \log_{10} \frac{101 \times |V_{OUT}|}{|V_{IN}|} \right|$$

15. Noise Input Voltage, VNI

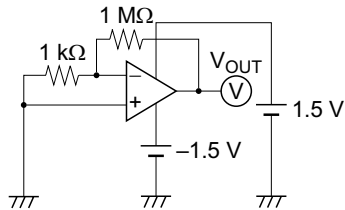

$$VNI = \frac{V_{OUT}}{1001}$$

Characteristic Curves

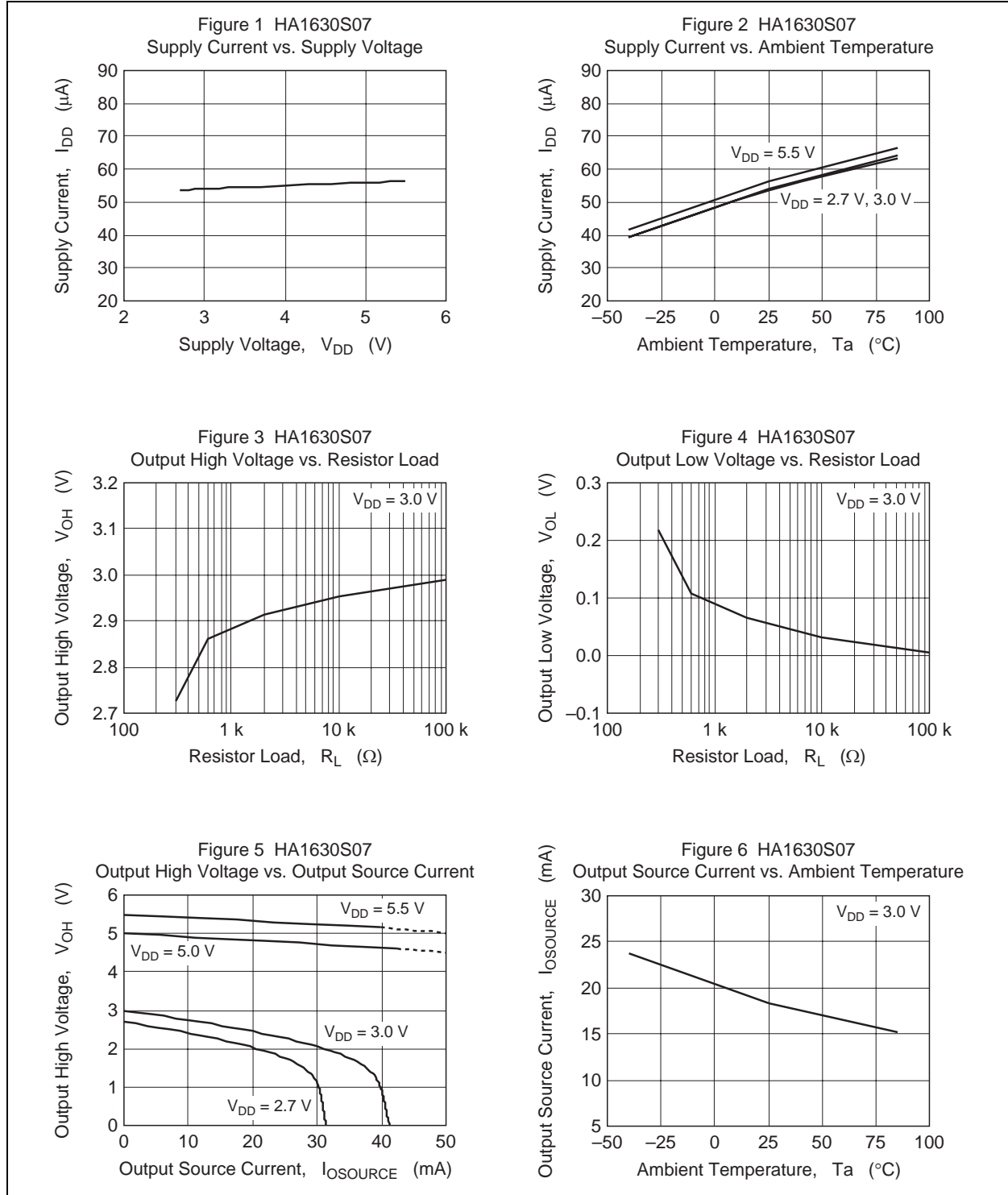

Characteristic Curves (cont.)

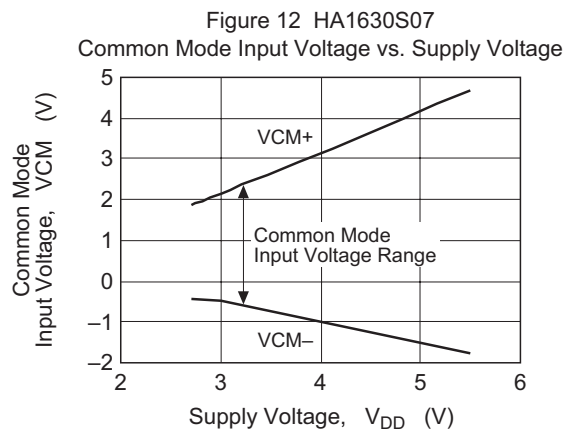
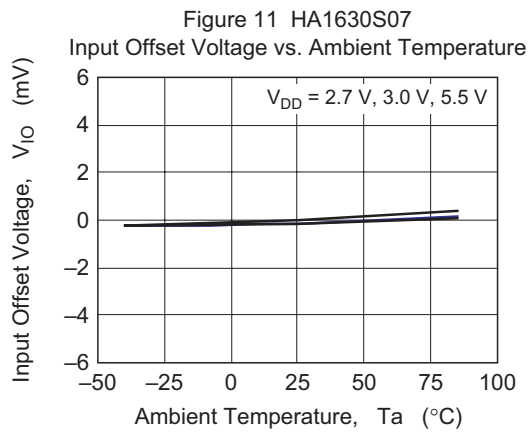
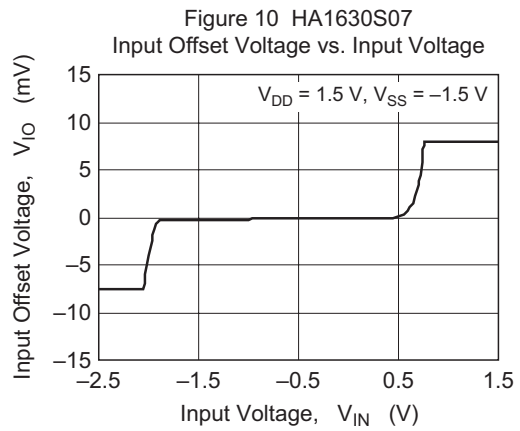
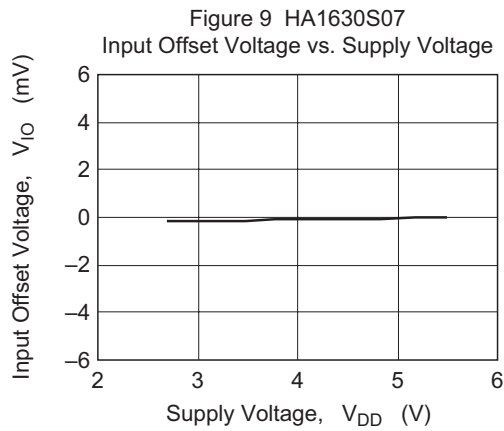
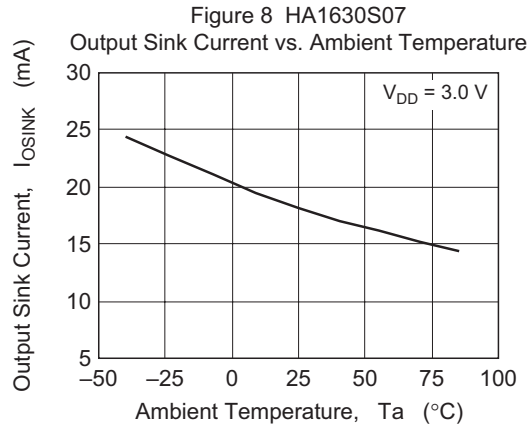
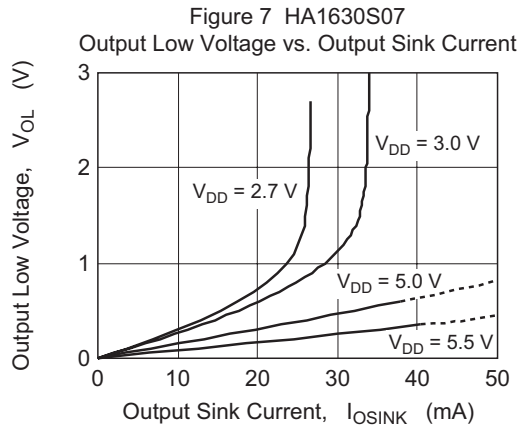

Characteristic Curves (cont.)

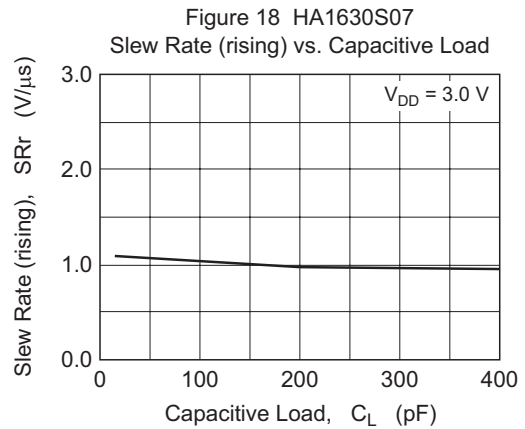
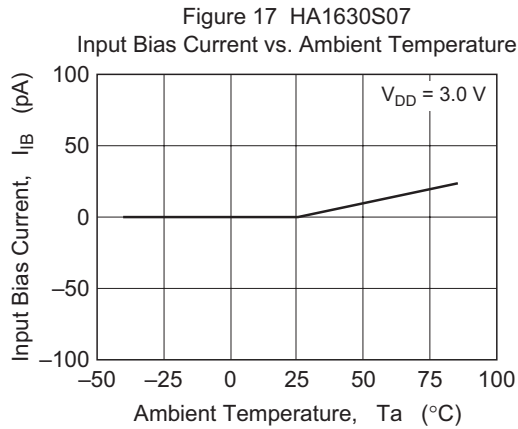
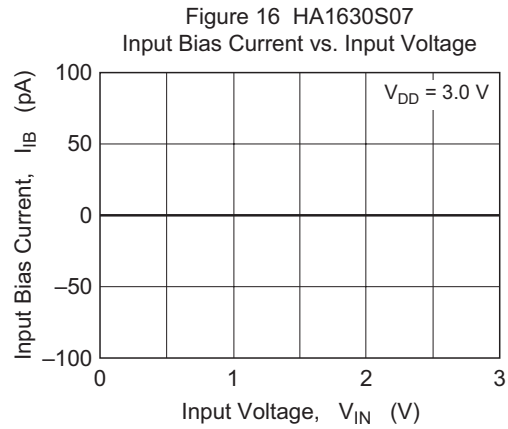
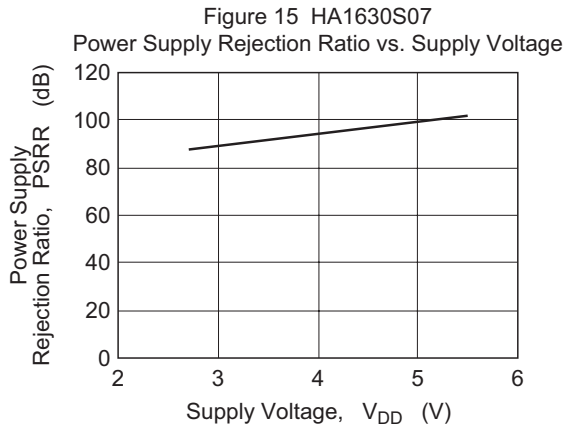
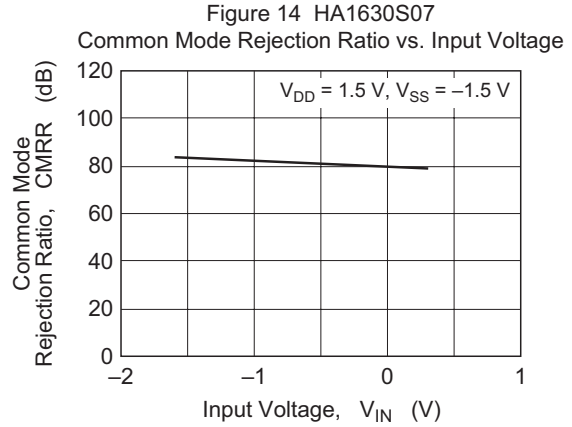
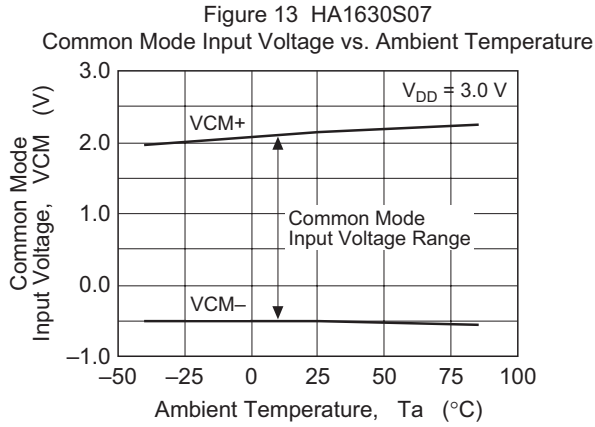

Characteristic Curves (cont.)

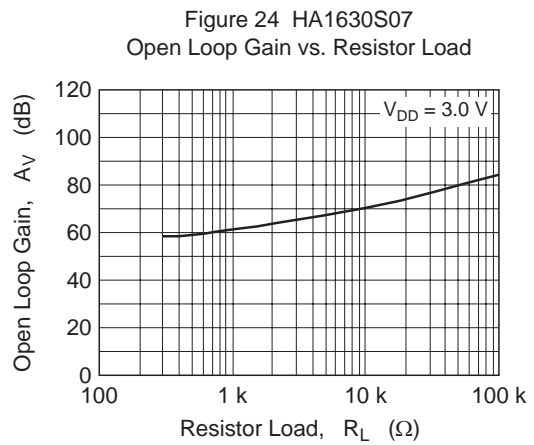
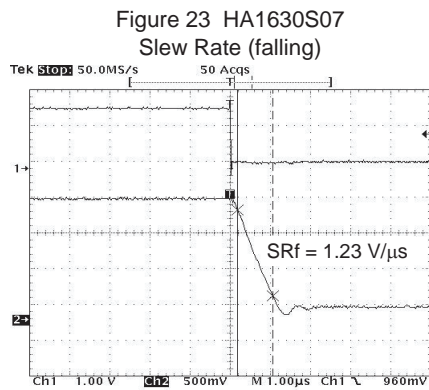
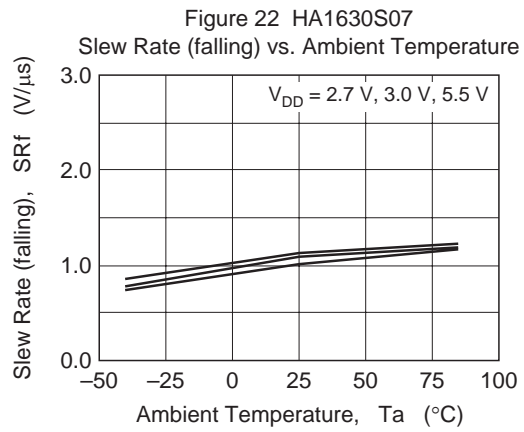
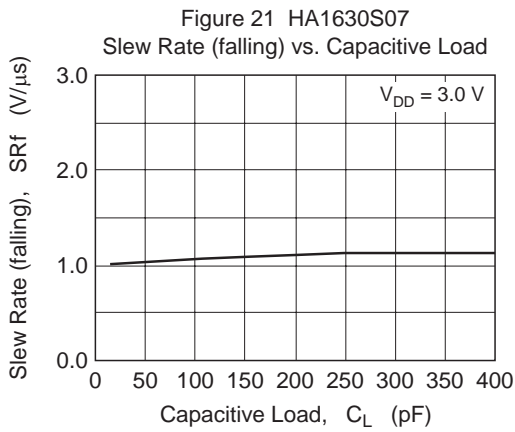
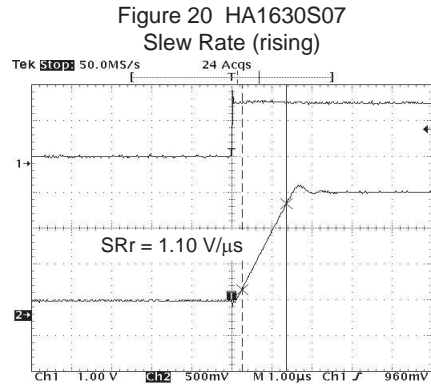
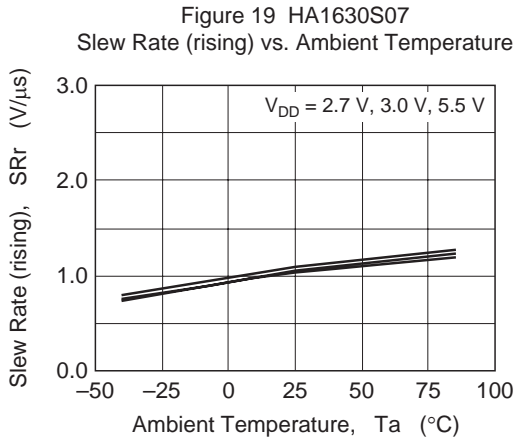

Characteristic Curves (cont.)

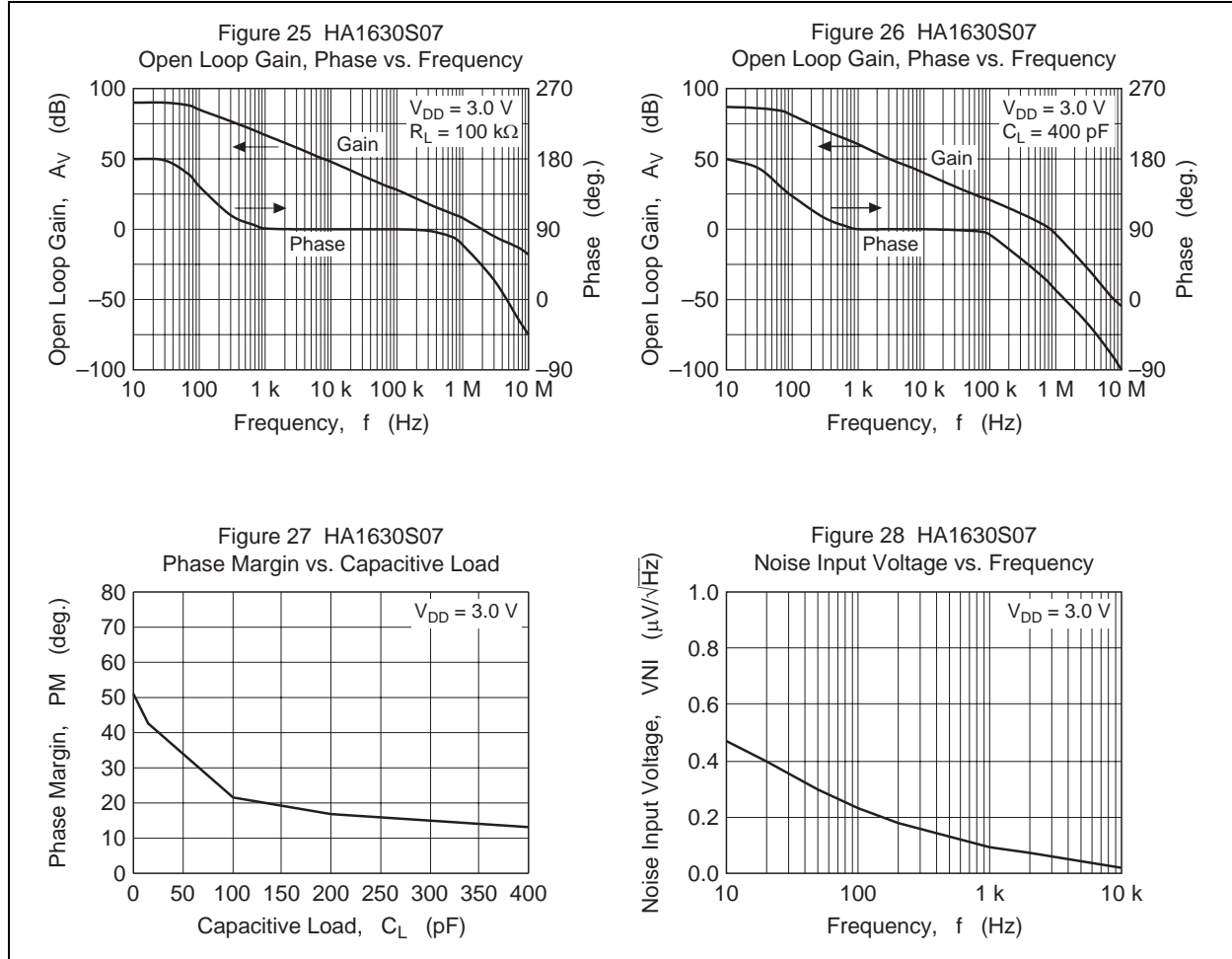

Package Dimensions

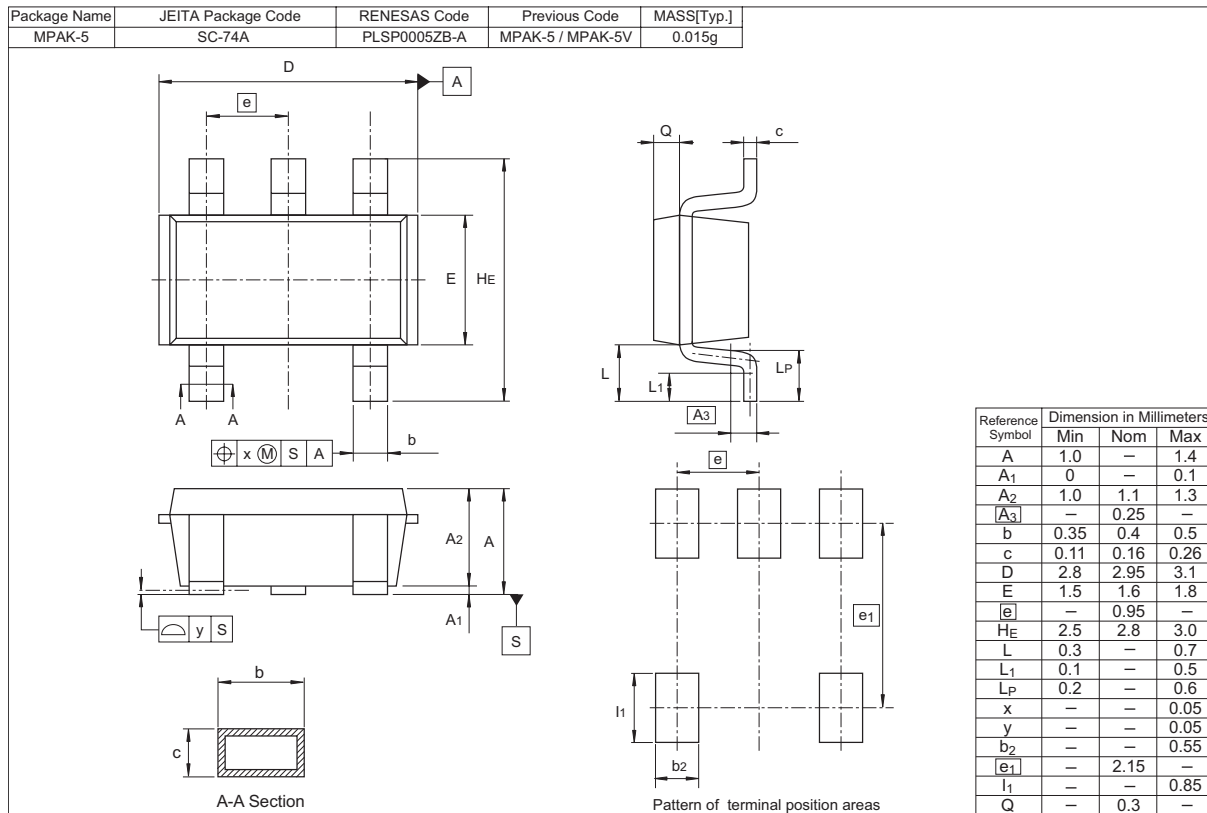
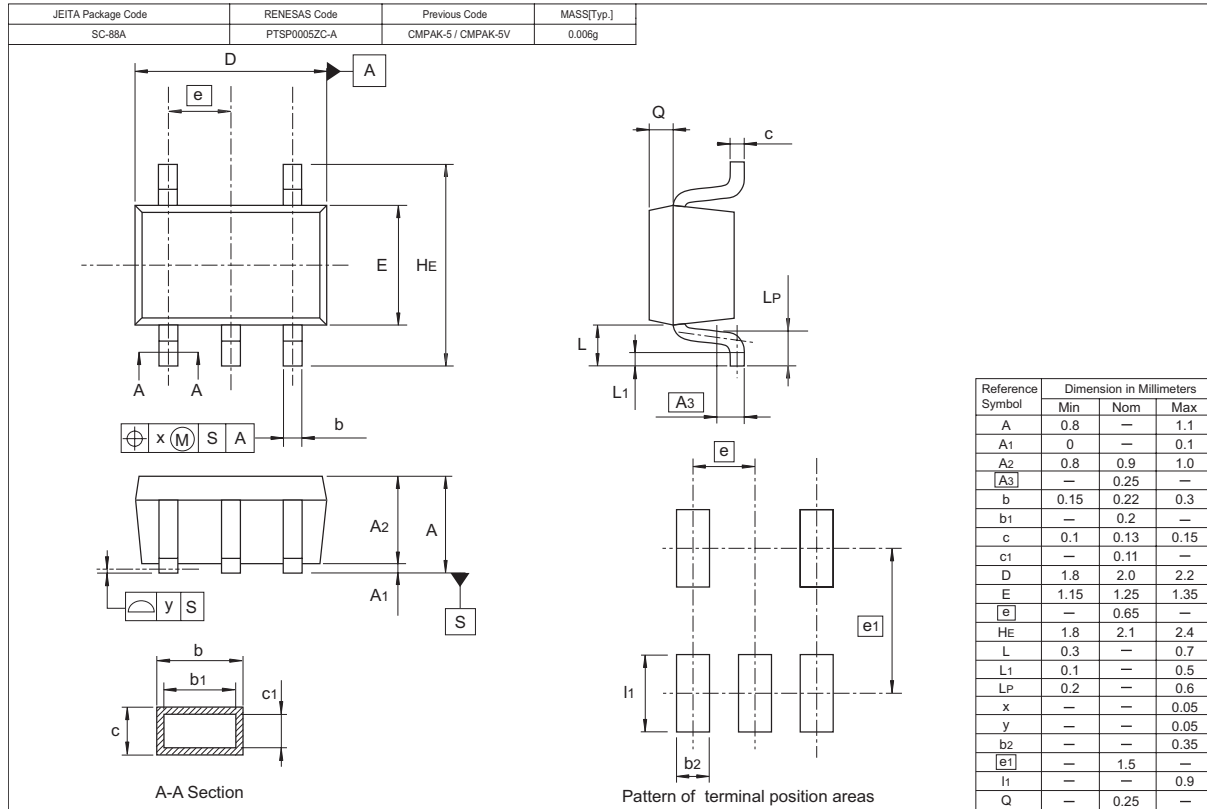

Taping & Reel Specification

[Taping]

Package Code	W	P	Ao	Bo	Ko	E	F	D1	Maximum Storage No.
MPAK-5	8	4	3.3	3.3	1.5	1.75	3.5	1.05	3,000 pcs/reel
CMPAK-5	8	4	2.25	2.45	1.1	1.75	3.5	1.05	3,000 pcs/reel

Unit: mm

[Reel]

Package	Tape width	W1	W2
MPAK-5	8	11.4	9
CMPAK-5	8	11.4	9

[Ordering Information]

Ordering Unit
3,000 pcs

Mark Indication

• MPAK-5

• CMPAK-5

Notes:

1. This document is provided for reference purposes only so that Renesas customers may select the appropriate Renesas products for their use. Renesas neither makes warranties or representations with respect to the accuracy or completeness of the information contained in this document nor grants any license to any intellectual property rights or any other rights of Renesas or any third party with respect to the information in this document.
2. Renesas shall have no liability for damages or infringement of any intellectual property or other rights arising out of the use of any information in this document, including, but not limited to, product data, diagrams, charts, programs, algorithms, and application circuit examples.
3. You should not use the products or the technology described in this document for the purpose of military applications such as the development of weapons of mass destruction or for the purpose of any other military use. When exporting the products or technology described herein, you should follow the applicable export control laws and regulations, and procedures required by such laws and regulations.
4. All information included in this document such as product data, diagrams, charts, programs, algorithms, and application circuit examples, is current as of the date this document is issued. Such information, however, is subject to change without any prior notice. Before purchasing or using any Renesas products listed in this document, please confirm the latest product information with a Renesas sales office. Also, please pay regular and careful attention to additional and different information to be disclosed by Renesas such as that disclosed through our website. (<http://www.renesas.com>)
5. Renesas has used reasonable care in compiling the information included in this document, but Renesas assumes no liability whatsoever for any damages incurred as a result of errors or omissions in the information included in this document.
6. When using or otherwise relying on the information in this document, you should evaluate the information in light of the total system before deciding about the applicability of such information to the intended application. Renesas makes no representations, warranties or guarantees regarding the suitability of its products for any particular application and specifically disclaims any liability arising out of the application and use of the information in this document or Renesas products.
7. With the exception of products specified by Renesas as suitable for automobile applications, Renesas products are not designed, manufactured or tested for applications or otherwise in systems the failure or malfunction of which may cause a direct threat to human life or create a risk of human injury or which require especially high quality and reliability such as safety systems, or equipment or systems for transportation and traffic, healthcare, combustion control, aerospace and aeronautics, nuclear power, or undersea communication transmission. If you are considering the use of our products for such purposes, please contact a Renesas sales office beforehand. Renesas shall have no liability for damages arising out of the uses set forth above.
8. Notwithstanding the preceding paragraph, you should not use Renesas products for the purposes listed below:
 - (1) artificial life support devices or systems
 - (2) surgical implantations
 - (3) healthcare intervention (e.g., excision, administration of medication, etc.)
 - (4) any other purposes that pose a direct threat to human lifeRenesas shall have no liability for damages arising out of the uses set forth in the above and purchasers who elect to use Renesas products in any of the foregoing applications shall indemnify and hold harmless Renesas Technology Corp., its affiliated companies and their officers, directors, and employees against any and all damages arising out of such applications.
9. You should use the products described herein within the range specified by Renesas, especially with respect to the maximum rating, operating supply voltage range, movement power voltage range, heat radiation characteristics, installation and other product characteristics. Renesas shall have no liability for malfunctions or damages arising out of the use of Renesas products beyond such specified ranges.
10. Although Renesas endeavors to improve the quality and reliability of its products, IC products have specific characteristics such as the occurrence of failure at a certain rate and malfunctions under certain use conditions. Please be sure to implement safety measures to guard against the possibility of physical injury, and injury or damage caused by fire in the event of the failure of a Renesas product, such as safety design for hardware and software including but not limited to redundancy, fire control and malfunction prevention, appropriate treatment for aging degradation or any other applicable measures. Among others, since the evaluation of microcomputer software alone is very difficult, please evaluate the safety of the final products or system manufactured by you.
11. In case Renesas products listed in this document are detached from the products to which the Renesas products are attached or affixed, the risk of accident such as swallowing by infants and small children is very high. You should implement safety measures so that Renesas products may not be easily detached from your products. Renesas shall have no liability for damages arising out of such detachment.
12. This document may not be reproduced or duplicated, in any form, in whole or in part, without prior written approval from Renesas.
13. Please contact a Renesas sales office if you have any questions regarding the information contained in this document, Renesas semiconductor products, or if you have any other inquiries.



RENESAS SALES OFFICES

<http://www.renesas.com>

Refer to "<http://www.renesas.com/en/network>" for the latest and detailed information.

Renesas Technology America, Inc.

450 Holger Way, San Jose, CA 95134-1368, U.S.A
Tel: <1> (408) 382-7500, Fax: <1> (408) 382-7501

Renesas Technology Europe Limited

Dukes Meadow, Millboard Road, Bourne End, Buckinghamshire, SL8 5FH, U.K.
Tel: <44> (1628) 585-100, Fax: <44> (1628) 585-900

Renesas Technology (Shanghai) Co., Ltd.

Unit 204, 205, AZIA Center, No.1233 Lujiazui Ring Rd, Pudong District, Shanghai, China 200120
Tel: <86> (21) 5877-1818, Fax: <86> (21) 6887-7858/7898

Renesas Technology Hong Kong Ltd.

7th Floor, North Tower, World Finance Centre, Harbour City, Canton Road, Tsimshatsui, Kowloon, Hong Kong
Tel: <852> 2265-6688, Fax: <852> 2377-3473

Renesas Technology Taiwan Co., Ltd.

10th Floor, No.99, Fushing North Road, Taipei, Taiwan
Tel: <886> (2) 2715-2888, Fax: <886> (2) 3518-3399

Renesas Technology Singapore Pte. Ltd.

1 Harbour Front Avenue, #06-10, Keppel Bay Tower, Singapore 098632
Tel: <65> 6213-0200, Fax: <65> 6278-8001

Renesas Technology Korea Co., Ltd.

Kukje Center Bldg, 18th Fl., 191, 2-ka, Hangang-ro, Yongsan-ku, Seoul 140-702, Korea
Tel: <82> (2) 796-3115, Fax: <82> (2) 796-2145

Renesas Technology Malaysia Sdn. Bhd

Unit 906, Block B, Menara Amcorp, Amcorp Trade Centre, No.18, Jln Persiaran Barat, 46050 Petaling Jaya, Selangor Darul Ehsan, Malaysia
Tel: <603> 7955-9390, Fax: <603> 7955-9510