



Frontier Electronics Corp.

667 E. COCHRAN STREET, SIMI VALLEY, CA 93065

TEL: (805) 522-9998 FAX: (805) 522-9989

E-mail: frontiersales@frontierusa.com

Web: <http://www.frontierusa.com>

3A ULTRA FAST RECOVERY SURFACE MOUNT RECTIFIER

US3A THRU US3M

FEATURES

- LOW PROFILE PACKAGE
- PLASTIC PACKAGE HAS UNDERWRITERS LABORATORY 94V-0
- IDEAL FOR SURFACE MOUNTED APPLICATION
- GLASS PASSIVATED CHIP JUNCTION
- BUILT-IN STRAIN RELIEF DESIGN
- ULTRA FAST RECOVERY TIME FOR HIGH EFFICIENT
- HIGH TEMPERATURE SOLDERING 250°C/10 SECONDS AT TERMINALS

MECHANICAL DATA

- CASE: JEDEC DO-214AB MOLDED PLASTIC BODY, DO-214AB (SMC), DIMENSIONS IN INCHES AND (MILLIMETERS)
- TERMINAL: SOLDER PLATED, SOLDERABLE PER MIL-STD-750 METHOD 2026
- POLARITY: COLOR BAND DENOTES CATHODE
- WEIGHT: 0.21GRAMS

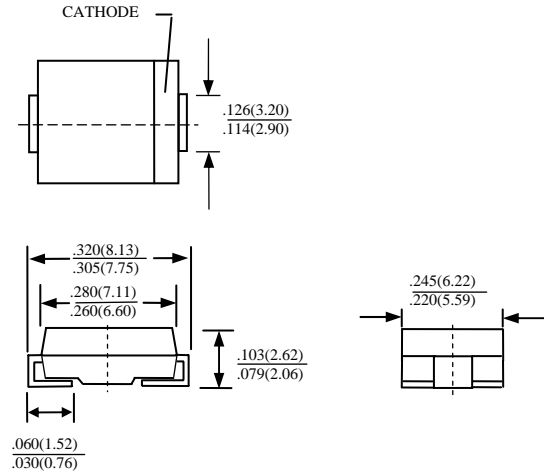

MAXIMUM RATINGS AND ELECTRICAL CHARACTERISTICS RATINGS AT 25°C AMBIENT TEMPERATURE UNLESS OTHERWISE SPECIFIED SINGLE PHASE, HALF WAVE, 60 HZ, RESISTIVE OR INDUCTIVE LOAD. FOR CAPACITIVE LOAD, DERATE CURRENT BY 20%

RATINGS	SYMBOL	US3A	US3B	US3D	US3G	US3J	US3K	US3M	UNITS	
MAXIMUM RECURRENT PEAK REVERSE VOLTAGE	V_{RRM}	50	100	200	400	600	800	1000	V	
MAXIMUM RMS VOLTAGE	V_{RMS}	35	70	140	280	420	560	700	V	
MAXIMUM DC BLOCKING VOLTAGE	V_{DC}	50	100	200	400	600	800	1000	V	
MAXIMUM AVERAGE FORWARD RECTIFIED CURRENT AT $T_J=75^\circ\text{C}$	I_O	3.0								A
PEAK FORWARD SURGE CURRENT, 8.3ms SINGLE HALF SINE-WAVE SUPERIMPOSED ON RATED LOAD	I_{FSM}	100								A
TYPICAL JUNCTION CAPACITANCE (NOTE 1)	C_J	75								PF
TYPICAL THERMAL RESISTANCE (NOTE 2)	$R_{\theta JL}$	15								°C/W
STORAGE TEMPERATURE RANGE	T_{STG}	-55 TO + 150								°C
OPERATING TEMPERATURE RANGE	T_{OP}	-55 TO + 150								°C

ELECTRICAL CHARACTERISTICS ($A_T T_A = 25^\circ\text{C}$ UNLESS OTHERWISE NOTED)

CHARACTERISTICS	SYMBOL	US3A	US3B	US3D	US3G	US3J	US3K	US3M	UNITS	
MAXIMUM FORWARD VOLTAGE AT I_O DC	V_F	1.0			1.3	1.7	1.85		V	
MAXIMUM DC REVERSE CURRENT AT $T_A=25^\circ\text{C}$	I_R	10								μA
MAXIMUM DC REVERSE CURRENT AT $T_A=125^\circ\text{C}$	I_R	250								μA
MAXIMUM REVERSE RECOVERY TIME (NOTE 3)	T_{RR}	50				75				nS
MARKING		US3A	US3B	US3D	US3G	US3J	US3K	US3M		

- NOTES: 1. MEASURED AT 1 MHZ AND APPLIED REVERSE VOLTAGE OF 4.0 VOLTS
 2. THERMAL RESISTANCE FROM JUNCTION TO AMBIENT AND JUNCTION TO LEAD P.C.B. MOUNTED ON 0.3 x 0.3" (8.0 x 8.0mm) COPPER PAD AREAS
 3. REVERSE RECOVERY TEST CONDITIONS: $I_F=0.5\text{A}$, $I_R=1.0\text{A}$, $I_{RR}=0.25\text{A}$

RATINGS AND CHARACTERISTIC CURVE US3A THRU US3M

FIG. 1-TEST CIRCUIT DIAGRAM AND REVERSE RECOVERY TIME CHARACTERISTIC

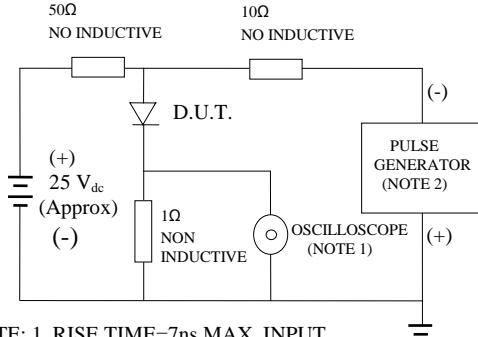

NOTE: 1. RISE TIME=7ns MAX. INPUT IMPEDANCE=1 MOhms 22PF
 2. RISE TIME =10ns MAX. SOURCE IMPEDANCE=50 OHMS

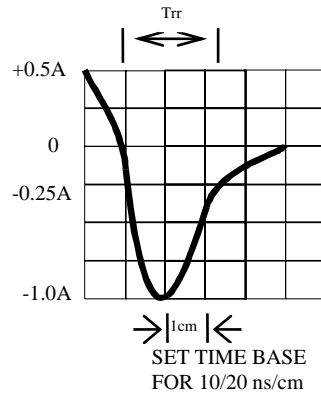

FIG. 2-TYPICAL FORWARD CURRENT DERATING CURVE

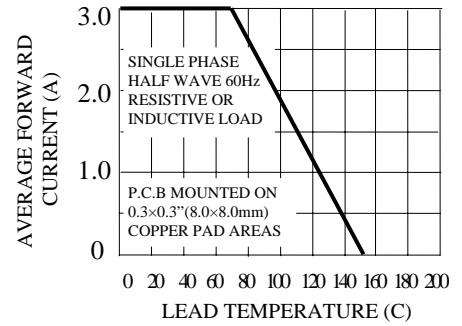

FIG. 3-TYPICAL REVERSE CHARACTERISTICS

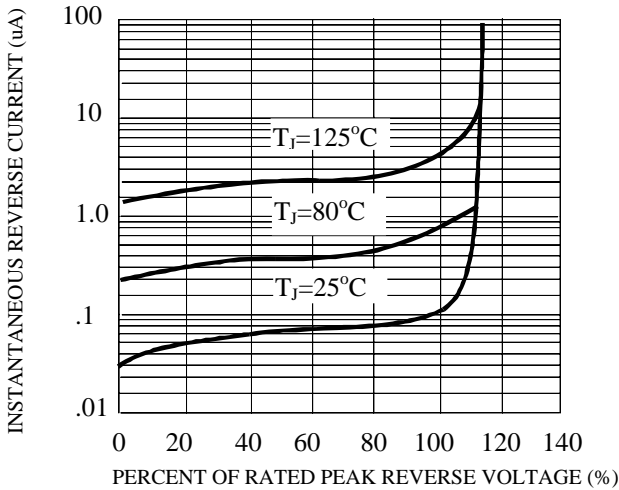

FIG. 4-TYPICAL INSTANTANEOUS FORWARD CHARACTERISTICS

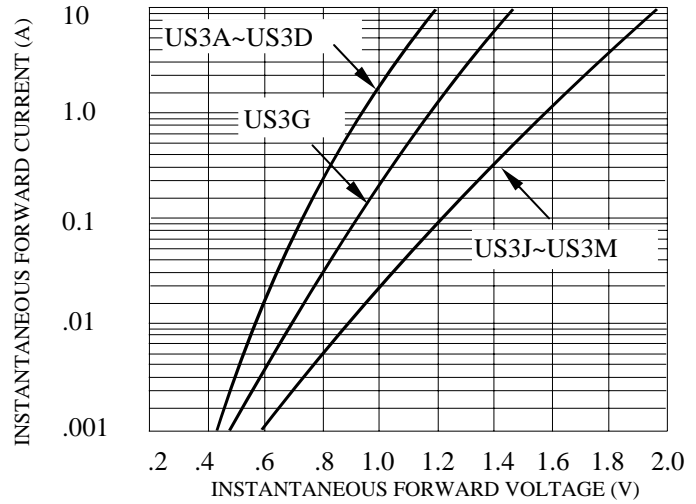

FIG. 5-MAXIMUM NON-REPETITIVE FORWARD SURGE CURRENT

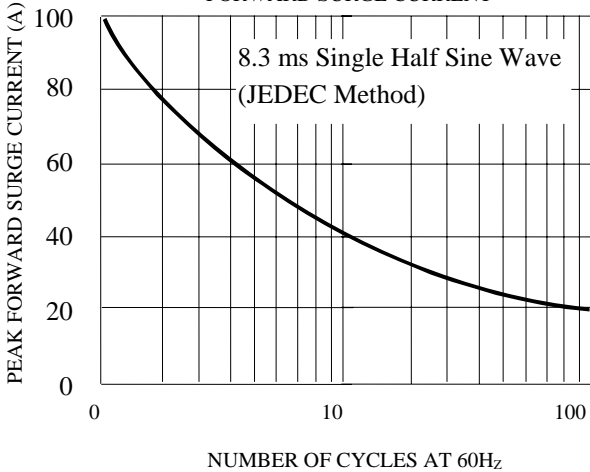

FIG. 6-TYPICAL JUNCTION CAPACITANCE

