



# Frontier Electronics Corp.

667 E. COCHRAN STREET, SIMI VALLEY, CA 93065

TEL: (805) 522-9998 FAX: (805) 522-9989

E-mail: [frontiersales@frontierusa.com](mailto:frontiersales@frontierusa.com)

Web: <http://www.frontierusa.com>

## 1A SURFACE MOUNT FAST RECOVERY RECTIFIERS RS4933 THRU RS4937

### FEATURES

- FOR SURFACE MOUNTED APPLICATIONS
- LOW PROFILE PACKAGE
- BUILT-IN STRAIN RELIEF
- EASY PICK AND PLACE
- PLASTIC MATERIAL USED CARRIES UNDERWRITERS LABORATORY CLASSIFICATION 94 V-0
- FAST SWITCHING
- HIGH TEMPERATURE SOLDERING: 250°C/10 SECONDS AT TERMINALS

### MECHANICAL DATA

- CASE: MOLDED PLASTIC, DO-214AC (SMA)
- DIMENSIONS IN INCHES AND (MILLIMETERS)
- TERMINALS: SOLDER PLATED
- POLARITY: INDICATED BY CATHODE BAND
- WEIGHT: 0.064 GRAMS

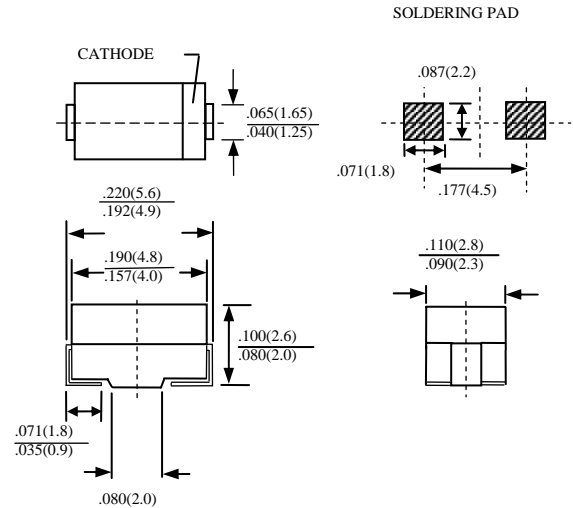

MAXIMUM RATINGS AND ELECTRICAL CHARACTERISTICS RATINGS AT 25°C AMBIENT TEMPERATURE UNLESS OTHERWISE SPECIFIED SINGLE PHASE, HALF WAVE, 60 HZ, RESISTIVE OR INDUCTIVE LOAD. FOR CAPACITIVE LOAD, DERATE CURRENT BY 20%

RATINGS	SYMBOL	RS4933	RS4934	RS4935	RS4936	RS4937	UNITS
MAXIMUM RECURRENT PEAK REVERSE VOLTAGE	$V_{RRM}$	50	100	200	400	600	V
MAXIMUM RMS VOLTAGE	$V_{RMS}$	35	70	140	280	420	V
MAXIMUM DC BLOCKING VOLTAGE	$V_{DC}$	50	100	200	400	600	V
MAXIMUM AVERAGE FORWARD RECTIFIED CURRENT AT $T_L=90^\circ\text{C}$	$I_O$	1.0					A
MAXIMUM OVERLOAD SURGE 8.3ms SINGLE HALF SINE-WAVE	$I_{FSM}$	30					A
TYPICAL JUNCTION CAPACITANCE (NOTE 1)	$C_J$	15					PF
STORAGE TEMPERATURE RANGE	$T_{STG}$	-55 TO + 150					°C
OPERATING TEMPERATURE RANGE	$T_{OP}$	-55 TO + 125					°C

### ELECTRICAL CHARACTERISTICS ( $A_T T_A = 25^\circ\text{C}$ UNLESS OTHERWISE NOTED)

CHARACTERISTICS	SYMBOL	RS4933	RS4934	RS4935	RS4936	RS4937	UNITS
MAXIMUM FORWARD VOLTAGE AT 1.0A AND 25°C	$V_F$	1.2					V
MAXIMUM REVERSE CURRENT AT 25°C	$I_R$	5					$\mu\text{A}$
MAXIMUM REVERSE RECOVERY TIME	$T_{RR}$	150					nS
MARKING		RS33	RS34	RS35	RS36	RS37	

NOTE: 1. MEASURED AT 1.0 MHZ AND APPLIED REVERSE VOLTAGE OF 4.0 V

# RATINGS AND CHARACTERISTIC CURVE RS4933 THRU RS4937

FIG. 1-TEST CIRCUIT DIAGRAM AND REVERSE RECOVERY TIME CHARACTERISTIC

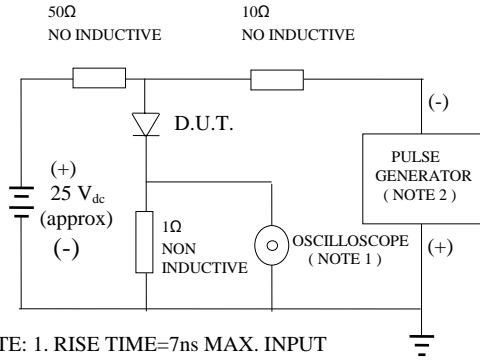

- NOTE: 1. RISE TIME=7ns MAX. INPUT IMPEDANCE=1 MOhms 22PF  
2. RISE TIME =10ns MAX. SOURCE IMPEDANCE=50 OHMS

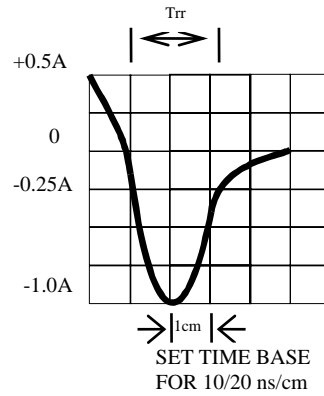

Fig. 2-MAXIMUM CURRENT DERATING CURVE

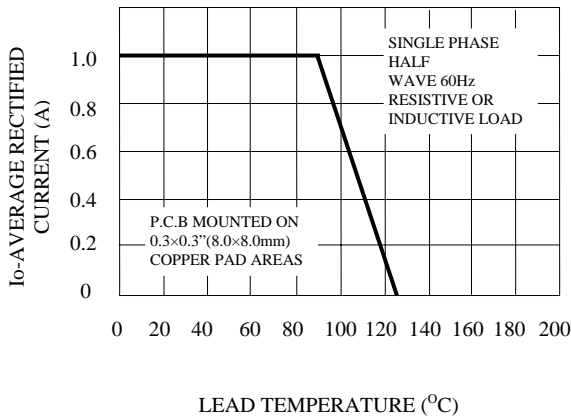

FIG. 3-TYPICAL JUNCTION CAPACITANCE

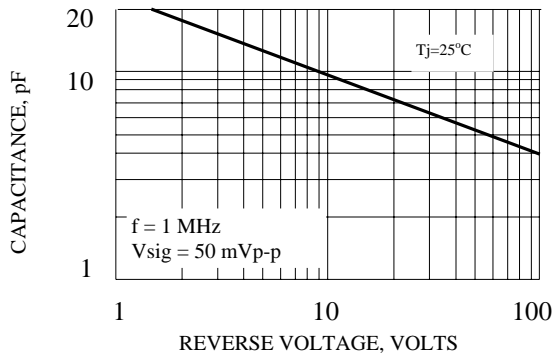

FIG. 4-TYPICAL REVERSE CHARACTERISTICS

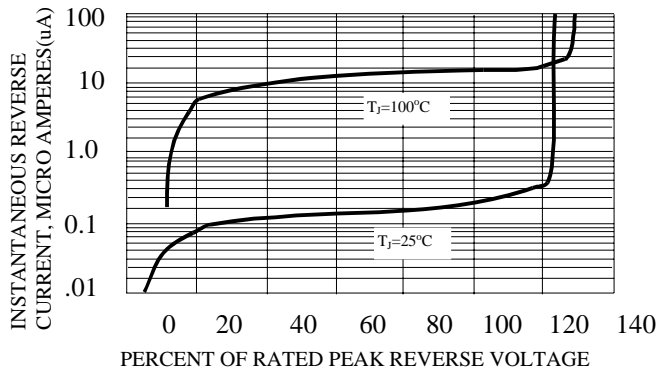

Fig. 5-MAXIMUM FORWARD SURGE CURRENT

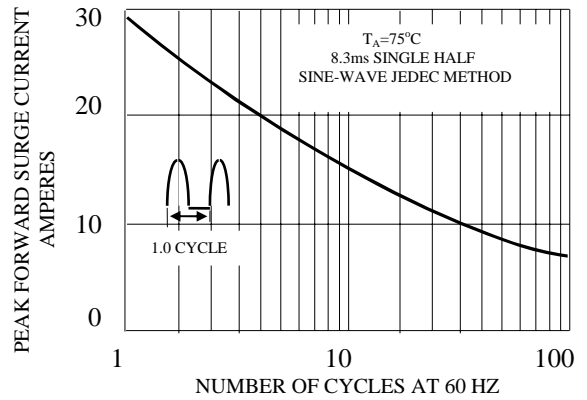

FIG. 6-TYPICAL INSTANTANEOUS FORWARD CHARACTERISTICS

