

1. PART NO. EXPRESSION :

S	D	B	1	0	0	3	1	0	1	M	Z	F	(a) Series code	(d) Tolerance code : M = ±20%
(a)	(b)	(c)	(d)(e)(f)	(b) Dimension code	(e) X, Y, Z : Standard part									
				(c) Inductance code : 101 = 100uH	(f) F : Lead Free									

2. CONFIGURATION & DIMENSIONS :

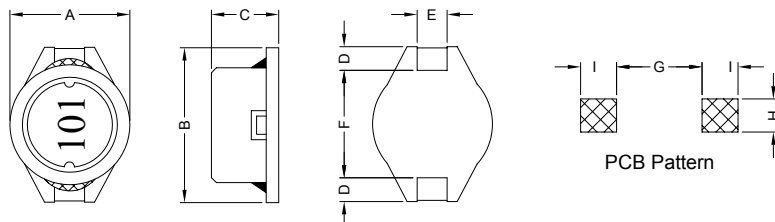

Unit:m/m

A	B	C	D	E	F	G	H	I
10.1±0.2	12.7±0.2	2.7±0.3	2.4±0.2	2.2±0.2	7.6±0.3	7.3 Ref.	2.8 Ref.	3.0 Ref.

3. SCHEMATIC :

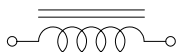

4. MATERIALS :

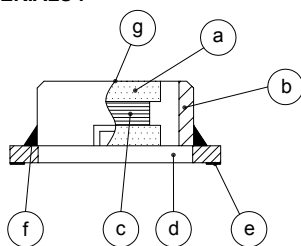

- (a) Core : DR Ferrite Core
- (b) Core : RI Ferrite Core
- (c) Wire : Enamelled Copper Wire
- (d) Base : LCP
- (e) Terminal : Tinned Copper Plate
- (f) Adhesive : Epoxy
- (g) Ink : Bon Margue

5. GENERAL SPECIFICATION :

- a) Temp. rise : 40°C Max.
- b) Rated current : Base on temp. rise & ΔL/L0A = 10% Max.
- c) Storage temp. : -40°C to +125°C
- d) Operating temp. : -40°C to +85°C
- e) Resistance to solder heat : 260°C.10 secs



RoHS Compliant

NOTE : Specifications subject to change without notice. Please check our website for latest information.

05.05.2008



SUPERWORLD ELECTRONICS (S) PTE LTD

PG. 1

6. ELECTRICAL CHARACTERISTICS :

Part No.	Inductance (μ H)	Q Ref.	Test Frequency (Hz)	SRF (MHz) Typ.	RDC (m Ω) Max.	IDC (A)
SDB10032R2MZF	2.2 \pm 20%	30	1V/100K	90.0	45	3.50
SDB10033R0MZF	3.0 \pm 20%	30	1V/100K	70.0	62	3.00
SDB10033R9MZF	3.9 \pm 20%	30	1V/100K	60.0	70	2.80
SDB10034R7MZF	4.7 \pm 20%	30	1V/100K	50.0	78	2.50
SDB10036R8MZF	6.8 \pm 20%	30	1V/100K	50.0	100	2.20
SDB1003100MZF	10.0 \pm 20%	30	1V/100K	38.0	145	2.00
SDB1003120MZF	12.0 \pm 20%	35	1V/100K	29.0	185	1.75
SDB1003150MZF	15.0 \pm 20%	35	1V/100K	30.0	200	1.50
SDB1003180MZF	18.0 \pm 20%	35	1V/100K	25.0	270	1.40
SDB1003220MZF	22.0 \pm 20%	40	1V/100K	22.0	300	1.30
SDB1003270MZF	27.0 \pm 20%	40	1V/100K	18.0	400	1.20
SDB1003330MZF	33.0 \pm 20%	40	1V/100K	17.0	450	1.10
SDB1003390MZF	39.0 \pm 20%	40	1V/100K	17.0	560	0.95
SDB1003470MZF	47.0 \pm 20%	40	1V/100K	15.0	650	0.80
SDB1003560MZF	56.0 \pm 20%	40	1V/100K	14.0	680	0.75
SDB1003680MZF	68.0 \pm 20%	40	1V/100K	12.0	800	0.70
SDB1003820MZF	82.0 \pm 20%	30	1V/100K	11.0	1200	0.65
SDB1003101MZF	100.0 \pm 20%	45	1V/100K	9.5	1400	0.60
SDB1003121MZF	120.0 \pm 20%	50	1V/100K	8.5	1520	0.55
SDB1003151MZF	150.0 \pm 20%	50	1V/100K	8.0	1800	0.50
SDB1003181MZF	180.0 \pm 20%	50	1V/100K	7.0	2200	0.45
SDB1003221MZF	220.0 \pm 20%	50	1V/100K	6.5	2200	0.40
SDB1003271LZF	270.0 \pm 15%	50	1V/100K	5.5	3100	0.35
SDB1003331LZF	330.0 \pm 15%	45	1V/100K	5.2	3600	0.30
SDB1003391LZF	390.0 \pm 15%	45	1V/100K	5.0	4600	0.25
SDB1003471LZF	470.0 \pm 15%	50	1V/100K	4.5	5100	0.20



RoHS Compliant

NOTE : Specifications subject to change without notice. Please check our website for latest information.

05.05.2008



SUPERWORLD ELECTRONICS (S) PTE LTD

PG. 2

6. ELECTRICAL CHARACTERISTICS :

@ TEMP. RISE VS. DC SUPERPOSITION RESPONSE CURVE

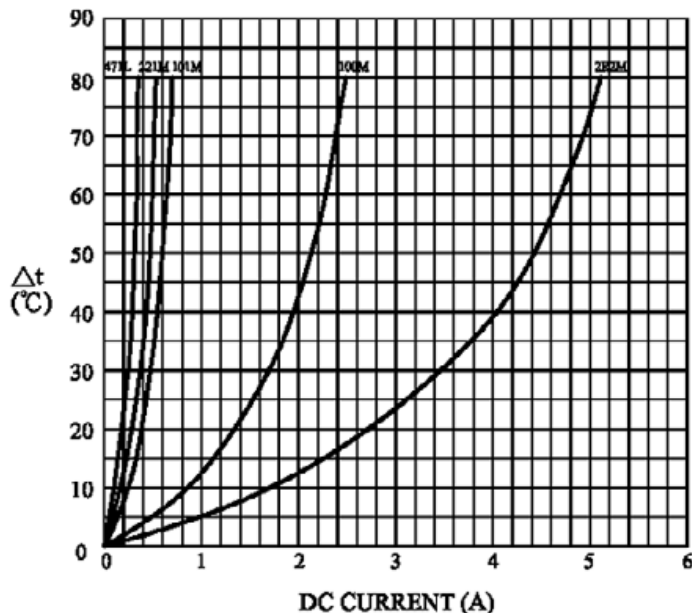

@ INDUCTANCE VS. FREQUENCY RESPONSE CURVE

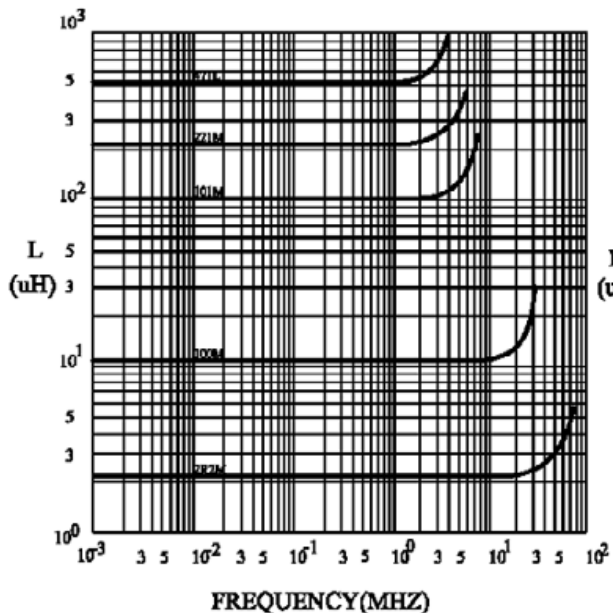

@ INDUCTANCE VS. DC SUPERPOSITION RESPONSE CURVE

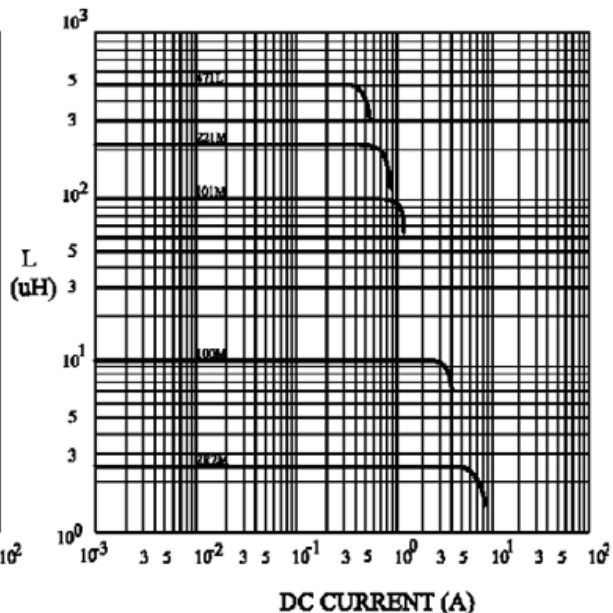

RoHS Compliant

NOTE : Specifications subject to change without notice. Please check our website for latest information.

05.05.2008



SUPERWORLD ELECTRONICS (S) PTE LTD

PG. 3

RECOMMENDED SOLDERING CONDITIONS REFLOW SOLDERINGS

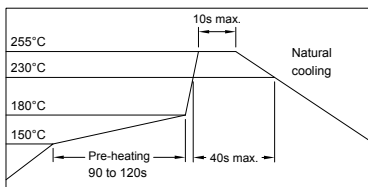

7. PACKAGING INFORMATION :

(1) CONFIGURATION

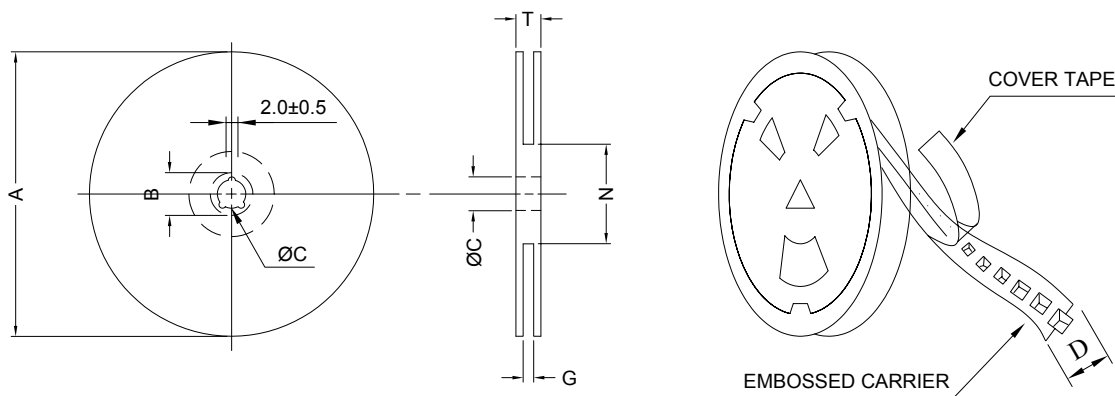

* CARRIER TAPE WIDTH : D

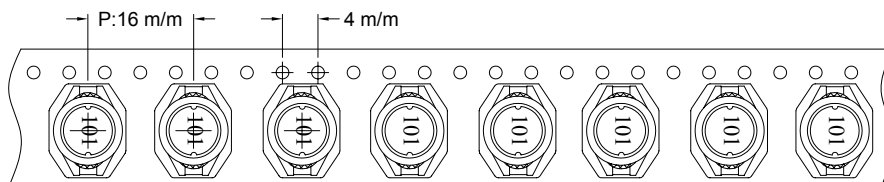

(2) DIMENSIONS

Unit:m/m

STYLE	A	B	C	D	G	N	T
13-24	330	21±0.8	13	24	26 ⁺⁰	50 ⁻⁰	30.4

(3) Q'TY & G.W. PER PACKAGE

SERIES	INNER : REEL			OUTER : CARTON		
	Q'TY (PCS)	G.W. (gw)	STYLE	Q'TY (PCS)	G.W. (Kg)	SIZE (cm)
SDB1003	1000	1000	13-24	4000	7.5	40 x 40 x 24



RoHS Compliant

NOTE : Specifications subject to change without notice. Please check our website for latest information.

05.05.2008

8. RELIABILITY AND TEST CONDITION :

TEST ITEM	SPECIFICATION	TEST CONDITION
SOLDERABILITY	MORE THAN 90% OF THE TERMINAL ELECTRODE SHALL BE COVERED WITH FRESH SOLDER.	PREHEAT : 125±25°C FOR 60 SECONDS SOLDER : 99%Sn/0.3%Ag/0.7%Cu OR EQUIVALENT SOLDER TEMP. : 245±5°C FLUX : ROSIN DIP TIME : 4±1 SECONDS
THERMAL SHOCK TEST (TEMP. CYCLE)	INDUCTANCE SHALL NOT CHANGE MORE THAN ±20%	ROOM TEMP. → -25±2°C 15 MINUTES 30 MINUTES ROOM TEMP. → 85±2°C 15 MINUTES 30 MINUTES TOTAL : 50 CYCLES
HUMIDITY RESISTANCE TEST		TEMPERATURE : 40±2°C HUMIDITY : 90 ~ 95% APPLIED CURRENT : PER SPEC. TIME : 500 HOURS
HIGH TEMP. RESISTANCE TEST		TEMPERATURE : 85±2°C APPLIED CURRENT : PER SPEC. TIME : 500 HOURS



RoHS Compliant

NOTE : Specifications subject to change without notice. Please check our website for latest information.

05.05.2008



SUPERWORLD ELECTRONICS (S) PTE LTD

PG. 5

9. UL CARD :

OBMW2 **November 30, 2000**
Magnet Wire - Component

PACIFIC ELECTRIC WIRE & CABLE (SHENZHEN) CO LTD **E201757**
 607 BAOLONG INDUSTRIAL ESTATE LONGGANG, SHENZHEN
 GUANGDONG CHINA

Mtl Dsg	Coating Type		ANSI Type	TI
UEW/U	BC	Polyurethane	—	130
PEW/U		Polyester	—	155°C
PEWH/U		Modified Polyester	—	180
PEW-NY/U		Polyester	Polyamide	155
HAI/U	Polyester(Amide)(Imide)	Polyamideimide	MW5-C	200
UEW-NY/U		Polyurethane	MW30-C	155
			MW80-C	130
			MW28-C	130

Marking: Company name and material designation or marked designation on package or reel, and Recognized Component Mark.

See General Information Preceding These Recognitions

1/3/2001 Underwriters Laboratories Inc. Card 1 of 2

SUMITOMO CHEMICAL CO LTD **E54705 (M)**
 5-33 KITAHAMA 4-CHOME CHUO-KO, OSAKA JAPAN

Mtl Dsg	Col	Min Thk mm	UL94 Flame Class	Elec	RTI with Imp	Mech w/o Imp	H W I	H A I	H V T R	D 4 5	C T I
Liquid crystal polyester (LCP), designated "EKONOL" or "SUMIKASUPER", furnished in the form of pellets, (Contd)											
E4008 , E400X	NC , BK	0.30	94V-0	130	130	130	—	—	—	—	—
		0.75	94V-0	130	130	130	3	4	—	—	—
		1.5	94V-0	130	130	130	2	4	—	—	—
		3.0	94V-0	130	130	130	1	4	0	5	4
E4008	NC , WT , BK	0.30	94V-0	130	130	130	—	—	—	—	—
		0.75	94V-0	220	180	220	3	4	—	—	—
		1.5	94V-0	220	200	240	2	4	—	—	—
		3.0	94V-0	220	200	240	1	4	0	5	4
E4010	NC , BK	0.30	94V-0	130	130	130	—	—	—	—	—
		0.75	94V-0	220	180	220	3	4	—	—	—
		1.5	94V-0	220	200	240	2	4	—	—	—
		3.0	94V-0	220	200	240	1	4	0	5	4
E400(Y)L , E4008L	NC , BK	0.30	94V-0	130	130	130	—	—	—	—	—
		0.75	94V-0	130	130	130	3	4	—	—	—
		1.5	94V-0	130	130	130	2	4	—	—	—
		3.0	94V-0	130	130	130	1	4	0	5	4
E4810	NC , BK	0.30	94V-0	130	130	130	—	—	—	—	—
		0.75	94V-0	130	130	130	0	4	—	—	—
		1.5	94V-0	130	130	130	0	4	—	—	—
		3.0	94V-0	130	130	130	1	4	0	5	4

(X) Denotes any number 1 thru 9.
 (Y) Denotes any number 1 thru 7.



RoHS Compliant

NOTE : Specifications subject to change without notice. Please check our website for latest information.

05.05.2008



SUPERWORLD ELECTRONICS (S) PTE LTD