



### OUTSTANDING CHARACTERISTICS

- Miniature size
- Very high Q at high frequencies
- High RF power capabilities
- Impervious to environmental conditions
- Low dissipation factors
- Excellent retrace capability (not applicable for X7R styles)
- High temperature stability
- Low noise
- Meets Mil-55681 with respect to: Shock, Vibration, Moisture Resistance, Solderability, Barometric Pressure, Temperature Cycling, Immersion and Salt Spray

### ADDITIONAL FEATURES

- Packaging options
- Lot processing data available

### MA SERIES

For filtering, coupling and impedance matching in most RF circuits, the MA Series chips and leaded devices offer outstanding performance and reliability with the greatest range of values and configurations. MA Series capacitors can be supplied with military equivalent screening. Please consult our factory.

MA Series ceramic fixed capacitors are miniature, high performance precision components having extremely high Q and high power capabilities from low frequencies to gigahertz ranges. These "low loss" multilayer capacitors are extremely stable with respect to variations in temperature, voltage and frequency.

MA Series capacitors are designed for miniature state-of-the-art circuit applications. They are small,

easy to apply and have excellent reliability. Units are available in ultra-miniature case size 1 (1.4 x 1.4 x 1.4mm) or miniature case size 2 (2.8 x 2.8 x 2.5mm). Standard case size 1 units are available as chips. Standard case size 2 units are available as chips and also in leaded configurations.

Clean-room manufacturing technology assures product reliability and automated processing reduces costs and cycle time. Key stages of the operation are monitored and controlled with the latest SPC techniques. Flexibility in design allows the production of non-standard values, while maintaining consistent quality objectives.

Please contact the factory for availability of special configurations or high-reliability screening.

### PART NUMBERING SYSTEM – CASE SIZE 1 & CASE SIZE 2

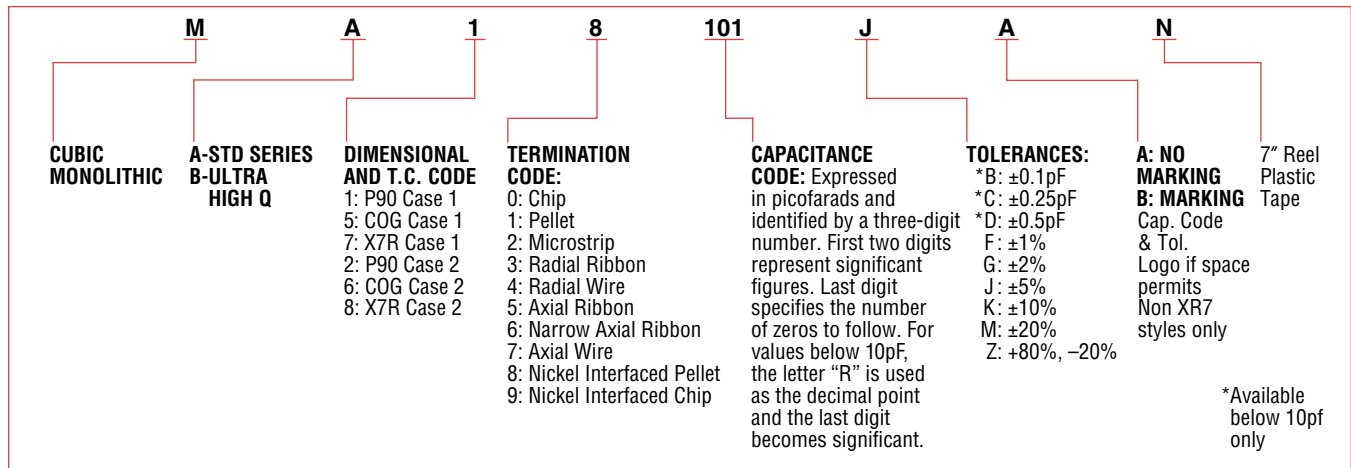

### SPECIAL LEAD CONFIGURATION FOR FLEX BOARDS



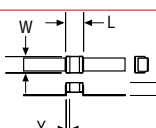



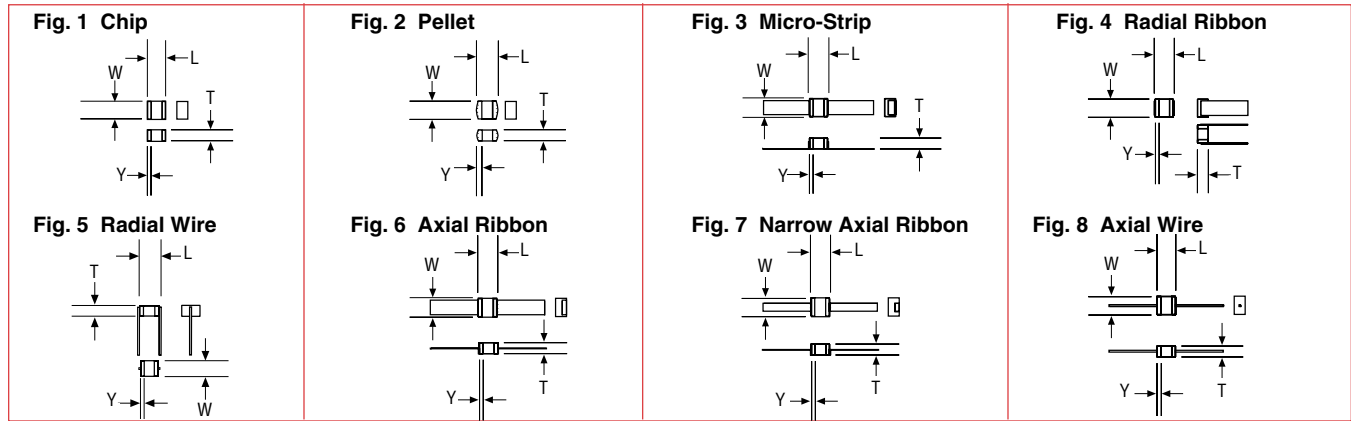







**NOTE:** Targeted for flex circuit boards, the MA22-6 version of the MA22 has an upraised lead configuration. The lead bends when flexing the board after assembly so that minimal stress is placed on the component.

| Style                            | Type     |          |        |        | Configuration   | Dimensions: mm |           |          |            | Termination  |
|----------------------------------|----------|----------|--------|--------|---|----------------|-----------|----------|------------|--|
|                                  | P90 ± 20 | P90 ± 30 | COG    | X7R    |   | L ± 0.38*      | W ± 0.38* | T ± .038 | Band Y     |  |
| <b>NEW</b><br>Raised Micro-Strip | MA22-6   | MB22-6   | MA62-6 | MA82-6 |  | 3.4            | 2.8       | 2.8      | 0.38 ± .25 | Silver Ribbon:<br>Length: 6.35 typical<br>Width: 2.3 ± .13<br>Thickness: 0.1 ± .05 |

### DIMENSIONS



### CONFIGURATION AND DIMENSIONS – MA & MB SERIES

| Style                    | Type     |          |      |      | Figure | Case Size                 | Configuration   | Dimensions: mm |           |        | Band Y     | Termination                                      |
|--------------------------|----------|----------|------|------|--------|---------------------------|---|----------------|-----------|--------|------------|--|
|                          | P90 ± 20 | P90 ± 30 | COG  | X7R  |        |                           |   | L ± 0.38*      | W ± 0.38* | T max. |            |  |
| Chip                     | MA10     | —        | MA50 | MA70 | 1      | 1<br>EIA<br>Style<br>0505 |    | 1.4 ± .25      | 1.4 ± .25 | 1.4    | 0.25 ± .1  | Palladium Silver                                 |
| Pellet                   | MA11     | —        | MA51 | MA71 | 2      |                           |    | 1.8 max.       |           |        |            | Palladium Silver & Sn62 Solder                   |
| Nickel Interfaced Pellet | MA18     | —        | MA58 | MA78 | 2      |                           |    | 1.4 ± .25      |           |        |            | Palladium Silver, Nickel Interface & Sn62 Solder |
| Nickel Interfaced Chip   | MA19     | —        | MA59 | MA79 | 1      |                           |  | 1.4 ± .25      |           |        |            | Palladium Silver, Nickel Interface & Tin Plating |
| Chip                     | MA20     | MB20     | MA60 | MA80 | 1      | 2<br>EIA<br>Style<br>1010 |  | 2.8            | 2.8       | 2.5    | 0.38 ± .25 | Palladium Silver                                 |
| Pellet                   | MA21     | MB21     | MA61 | MA81 | 2      |                           |  | 3.3 max.       |           |        |            | Palladium Silver, & Sn62 Solder                  |
| Micro Strip              | MA22     | MB22     | MA62 | MA82 | 3      |                           |  | 3.4            |           |        |            | Silver Ribbon: 6.35 x 2.3 x 0.1mm                |
| Radial Ribbon            | MA23     | MB23     | MA63 | MA83 | 4      |                           |  | 3.4            |           |        |            | Silver Ribbon: 6.35 x 2.3 x 0.1mm                |
| Radial Wire              | MA24     | MB24     | MA64 | MA84 | 5      |                           |  | 3.8            |           |        |            | #26AWG Silver Wire: 12.7 x 0.4mm Dia.            |
| Axial Ribbon             | MA25     | MB25     | MA65 | MA85 | 6      |                           |  | 3.4            |           |        |            | Silver Ribbon: 6.35 x 2.3 x 0.1mm                |
| Narrow Axial Ribbon      | MA26     | MB26     | MA66 | MA86 | 7      |                           |  | 3.4            |           |        |            | Silver Ribbon: 6.35 x 1.25 x 0.1mm               |
| Axial Wire               | MA27     | MB27     | MA67 | MA87 | 8      |                           |  | 3.8            |           |        |            | #26AWG Silver Wire: 12.7mm x 0.4mm Dia.          |
| Nickel Interfaced Pellet | MA28     | MB28     | MA68 | MA88 | 2      |                           |  | 3.3 max.       |           |        |            | Palladium Silver, Nickel Interface & Sn62 Solder |
| Nickel Interfaced Chip   | MA29     | MB29     | MA69 | MA89 | 1      |                           |  | 2.8            |           |        |            | Palladium Silver, Nickel Interface & Tin Plating |

\*Except where Tolerance is shown. Lead lengths are typical widths ±0.1mm, thickness & dia. ±0.05mm. All leaded parts are bonded with high temperature solder 748°F/398°C.

# APPLICATION SPECIFIC CAPACITORS MINIATURE MICROWAVE CERAMIC CAPACITORS



## MA Case Size 1 Series

### MA10 & 50 SERIES, P90 & COG – CASE SIZE 1

| Cap. Code | Cap. pF | Cap. Tol. | WVDC* |
|-----------|---------|-----------|-------|
| 0R1       | 0.1     | B         | 150   |
| 0R2       | 0.2     | "         | 150   |
| 0R3       | 0.3     | B,C       | 150   |
| 0R4       | 0.4     | "         | 150   |
| 0R5       | 0.5     | B,C,D     | 150   |
| 0R6       | 0.6     | "         | 150   |
| 0R7       | 0.7     | "         | 150   |
| 0R8       | 0.8     | "         | 150   |
| 0R9       | 0.9     | "         | 150   |
| 1R0       | 1.0     | "         | 150   |
| 1R1       | 1.1     | "         | 150   |
| 1R2       | 1.2     | "         | 150   |
| 1R3       | 1.3     | "         | 150   |
| 1R4       | 1.4     | "         | 150   |
| 1R5       | 1.5     | "         | 150   |
| 1R6       | 1.6     | "         | 150   |
| 1R7       | 1.7     | "         | 150   |
| 1R8       | 1.8     | "         | 150   |
| 1R9       | 1.9     | "         | 150   |
| 2R0       | 2.0     | "         | 150   |
| 2R2       | 2.2     | "         | 150   |
| 2R4       | 2.4     | "         | 150   |
| 2R7       | 2.7     | "         | 150   |
| 3R0       | 3.0     | "         | 150   |
| 3R3       | 3.3     | "         | 150   |
| 3R6       | 3.6     | "         | 150   |
| 3R9       | 3.9     | "         | 150   |
| 4R3       | 4.3     | "         | 150   |

\*@ 125°C

| Cap. Code | Cap. pF | Cap. Tol. | WVDC* |
|-----------|---------|-----------|-------|
| 4R7       | 4.7     | B,C,D     | 150   |
| 5R1       | 5.1     | "         | 150   |
| 5R6       | 5.6     | "         | 150   |
| 6R2       | 6.2     | "         | 150   |
| 6R8       | 6.8     | B,C,J,K,M | 150   |
| 7R5       | 7.5     | "         | 150   |
| 8R2       | 8.2     | "         | 150   |
| 9R1       | 9.1     | "         | 150   |
| 100       | 10      | F,G,J,K,M | 150   |
| 110       | 11      | "         | 150   |
| 120       | 12      | "         | 150   |
| 130       | 13      | "         | 150   |
| 150       | 15      | "         | 150   |
| 160       | 16      | "         | 150   |
| 180       | 18      | "         | 150   |
| 200       | 20      | "         | 150   |
| 220       | 22      | "         | 150   |
| 240       | 24      | "         | 150   |
| 270       | 27      | "         | 150   |
| 300       | 30      | "         | 150   |
| 330       | 33      | "         | 150   |
| 360       | 36      | "         | 150   |
| 390       | 39      | "         | 150   |
| 430       | 43      | "         | 150   |
| 470       | 47      | "         | 150   |
| 510       | 51      | "         | 150   |
| 560       | 56      | "         | 150   |
| 620       | 62      | "         | 150   |

\*@ 125°C

| Cap. Code | Cap. pF | Cap. Tol. | WVDC* |
|-----------|---------|-----------|-------|
| 680       | 68      | F,G,J,K,M | 150   |
| 750       | 75      | "         | 150   |
| 820       | 82      | "         | 150   |
| 910       | 91      | "         | 150   |
| 101       | 100     | "         | 150   |
| 111**     | 110     | "         | 50    |
| 121**     | 120     | "         | 50    |
| 131**     | 130     | "         | 50    |
| 151**     | 150     | "         | 50    |
| 161**     | 160     | "         | 50    |
| 181**     | 180     | "         | 50    |
| 201**     | 200     | "         | 50    |
| 221**     | 220     | "         | 50    |
| 241**     | 240     | "         | 50    |
| 271**     | 270     | "         | 50    |
| 301**     | 300     | "         | 50    |
| 331**     | 330     | "         | 50    |
| 361**     | 360     | "         | 50    |
| 391**     | 390     | "         | 50    |
| 431**     | 430     | "         | 50    |
| 471**     | 470     | "         | 50    |
| 511**     | 510     | "         | 50    |
| 561**     | 560     | "         | 50    |
| 621**     | 620     | "         | 50    |
| 681**     | 680     | "         | 50    |
| 751**     | 750     | "         | 50    |
| 821**     | 820     | "         | 50    |
| 911**     | 910     | "         | 50    |
| 102**     | 1000    | "         | 50    |

\*@ 125°C

\*\*Extended Cap Range, COG only

### MA70 SERIES, X7R – CASE SIZE 1

| Cap. Code | Cap. pF | Cap. Tol. | WVDC*** |
|-----------|---------|-----------|---------|
| 511       | 510     | K,M,Z     | 50      |
| 561       | 560     | "         | 50      |
| 621       | 620     | "         | 50      |
| 681       | 680     | "         | 50      |
| 751       | 750     | "         | 50      |
| 821       | 820     | "         | 50      |
| 911       | 910     | "         | 50      |
| 102       | 1000    | "         | 50      |
| 112       | 1100    | "         | 50      |
| 122       | 1200    | "         | 50      |
| 132       | 1300    | "         | 50      |

\*\*\*@ 85°C

| Cap. Code | Cap. pF | Cap. Tol. | WVDC*** |
|-----------|---------|-----------|---------|
| 152       | 1500    | K,M,Z     | 50      |
| 162       | 1600    | "         | 50      |
| 182       | 1800    | "         | 50      |
| 202       | 2000    | "         | 50      |
| 222       | 2200    | "         | 50      |
| 242       | 2400    | "         | 50      |
| 272       | 2700    | "         | 50      |
| 302       | 3000    | "         | 50      |
| 332       | 3300    | "         | 50      |
| 362       | 3600    | "         | 50      |
| 392       | 3900    | "         | 50      |

\*\*\*@ 85°C

| Cap. Code | Cap. pF | Cap. Tol. | WVDC*** |
|-----------|---------|-----------|---------|
| 432       | 4300    | K,M,Z     | 50      |
| 472       | 4700    | "         | 50      |
| 512       | 5100    | "         | 50      |
| 562       | 5600    | "         | 50      |
| 622       | 6200    | "         | 50      |
| 682       | 6800    | "         | 50      |
| 752       | 7500    | "         | 50      |
| 822       | 8200    | "         | 50      |
| 912       | 9100    | "         | 50      |
| 103       | 10000   | "         | 50      |

\*\*\*@ 85°C

# APPLICATION SPECIFIC CAPACITORS MINIATURE MICROWAVE CERAMIC CAPACITORS



## MA Case Size 2 Series

### MA20 & 60 SERIES, P90 & COG – CASE SIZE 2

| Cap. Code | Cap. pF | Cap. Tol. | WVDC* |
|-----------|---------|-----------|-------|
| 0R1       | 0.1     | B         | 500   |
| 0R2       | 0.2     | "         | 500   |
| 0R3       | 0.3     | B,C       | 500   |
| 0R4       | 0.4     | "         | 500   |
| 0R5       | 0.5     | B,C,D     | 500   |
| 0R6       | 0.6     | "         | 500   |
| 0R7       | 0.7     | "         | 500   |
| 0R8       | 0.8     | "         | 500   |
| 0R9       | 0.9     | "         | 500   |
| 1R0       | 1.0     | "         | 500   |
| 1R1       | 1.1     | "         | 500   |
| 1R2       | 1.2     | "         | 500   |
| 1R3       | 1.3     | "         | 500   |
| 1R4       | 1.4     | "         | 500   |
| 1R5       | 1.5     | "         | 500   |
| 1R6       | 1.6     | "         | 500   |
| 1R7       | 1.7     | "         | 500   |
| 1R8       | 1.8     | "         | 500   |
| 1R9       | 1.9     | "         | 500   |
| 2R0       | 2.0     | "         | 500   |
| 2R1       | 2.1     | "         | 500   |
| 2R2       | 2.2     | "         | 500   |
| 2R4       | 2.4     | "         | 500   |
| 2R7       | 2.7     | "         | 500   |
| 3R0       | 3.0     | "         | 500   |
| 3R3       | 3.3     | "         | 500   |
| 3R6       | 3.6     | "         | 500   |
| 3R9       | 3.9     | "         | 500   |
| 4R3       | 4.3     | "         | 500   |
| 4R7       | 4.7     | "         | 500   |
| 5R1       | 5.1     | "         | 500   |
| 5R6       | 5.6     | "         | 500   |
| 6R2       | 6.2     | "         | 500   |
| 6R8       | 6.8     | B,C,J,K,M | 500   |

\*@ 125°C

Note: Limited capacitance range available in 1Kv; consult factory.

| Cap. Code | Cap. pF | Cap. Tol. | WVDC* |
|-----------|---------|-----------|-------|
| 7R5       | 7.5     | "         | 500   |
| 8R2       | 8.2     | B,C,J,K,M | 500   |
| 9R1       | 9.1     | "         | 500   |
| 100       | 10      | F,G,J,K,M | 500   |
| 110       | 11      | "         | 500   |
| 120       | 12      | "         | 500   |
| 130       | 13      | "         | 500   |
| 150       | 15      | "         | 500   |
| 160       | 16      | "         | 500   |
| 180       | 18      | "         | 500   |
| 200       | 20      | "         | 500   |
| 220       | 22      | "         | 500   |
| 240       | 24      | "         | 500   |
| 270       | 27      | "         | 500   |
| 300       | 30      | "         | 500   |
| 330       | 33      | "         | 500   |
| 360       | 36      | "         | 500   |
| 390       | 39      | "         | 500   |
| 430       | 43      | "         | 500   |
| 470       | 47      | "         | 500   |
| 510       | 51      | "         | 500   |
| 560       | 56      | "         | 500   |
| 620       | 62      | "         | 500   |
| 680       | 68      | "         | 500   |
| 750       | 75      | "         | 500   |
| 820       | 82      | "         | 500   |
| 910       | 91      | "         | 500   |
| 101       | 100     | "         | 500   |
| 111       | 110     | "         | 300   |
| 121       | 120     | "         | 300   |
| 131       | 130     | "         | 300   |
| 151       | 150     | "         | 300   |
| 161       | 160     | "         | 300   |
| 181       | 180     | "         | 300   |

\*@ 125°C

| Cap. Code | Cap. pF | Cap. Tol. | WVDC* |
|-----------|---------|-----------|-------|
| 201       | 200     | "         | 300   |
| 221       | 220     | "         | 200   |
| 241       | 240     | F,G,J,K,M | 200   |
| 271       | 270     | "         | 200   |
| 301       | 300     | "         | 200   |
| 331       | 330     | "         | 200   |
| 361       | 360     | "         | 200   |
| 391       | 390     | "         | 200   |
| 431       | 430     | "         | 200   |
| 471       | 470     | "         | 200   |
| 511       | 510     | "         | 100   |
| 561       | 560     | "         | 100   |
| 621       | 620     | "         | 100   |
| 681       | 680     | "         | 50    |
| 751       | 750     | "         | 50    |
| 821       | 820     | "         | 50    |
| 911       | 910     | "         | 50    |
| 102       | 1000    | "         | 50    |
| 112**     | 1100    | "         | 50    |
| 122**     | 1200    | "         | 50    |
| 132**     | 1300    | "         | 50    |
| 152**     | 1500    | "         | 50    |
| 162**     | 1600    | "         | 50    |
| 182**     | 1800    | "         | 50    |
| 202**     | 2000    | "         | 50    |
| 222**     | 2200    | "         | 50    |
| 242**     | 2400    | "         | 50    |
| 272**     | 2700    | "         | 50    |
| 302**     | 3000    | "         | 50    |
| 332**     | 3300    | "         | 50    |
| 362**     | 3600    | "         | 50    |
| 392**     | 3900    | "         | 50    |
| 432**     | 4300    | "         | 50    |
| 472**     | 4700    | "         | 50    |
| 512**     | 5200    | "         | 50    |

\*@ 125°C

\*\*Extended Cap Range, COG only

APPLICATION SPECIFIC CAPACITORS

### MA80 SERIES, X7R – CASE SIZE 2

| Cap. Code | Cap. pF | Cap. Tol. | WVDC** |
|-----------|---------|-----------|--------|
| 512       | 5100    | K,M,Z     | 100    |
| 562       | 5600    | "         | 100    |
| 622       | 6200    | "         | 100    |
| 682       | 6800    | "         | 100    |
| 752       | 7500    | "         | 100    |
| 822       | 8200    | "         | 100    |
| 912       | 9100    | "         | 100    |
| 103       | 10000   | "         | 100    |
| 113       | 11000   | "         | 100    |
| 123       | 12000   | "         | 100    |
| 133       | 13000   | "         | 100    |

\*\*@ 85°C

| Cap. Code | Cap. pF | Cap. Tol. | WVDC** |
|-----------|---------|-----------|--------|
| 153       | 15000   | K,M,Z     | 100    |
| 163       | 16000   | "         | 100    |
| 183       | 18000   | "         | 100    |
| 203       | 20000   | "         | 100    |
| 223       | 22000   | "         | 100    |
| 243       | 24000   | "         | 100    |
| 273       | 27000   | "         | 100    |
| 303       | 30000   | "         | 100    |
| 333       | 33000   | "         | 100    |
| 363       | 36000   | "         | 100    |
| 393       | 39000   | "         | 100    |

\*\*@ 85°C

| Cap. Code | Cap. pF | Cap. Tol. | WVDC** |
|-----------|---------|-----------|--------|
| 433       | 43000   | K,M,Z     | 100    |
| 473       | 47000   | "         | 100    |
| 513       | 51000   | "         | 100    |
| 563       | 56000   | "         | 100    |
| 623       | 62000   | "         | 100    |
| 683       | 68000   | "         | 100    |
| 753       | 75000   | "         | 100    |
| 823       | 82000   | "         | 100    |
| 913       | 91000   | "         | 100    |
| 104       | 100000  | "         | 100    |

\*\*@ 85°C

# APPLICATION SPECIFIC CAPACITORS MINIATURE MICROWAVE CERAMIC CAPACITORS



## MB Case Size 2 Series

### MB20 ~ 29 SERIES, P90 ± 30 – CASE SIZE 2

| Cap. Code | Cap. pF | Cap. Tol. | WVDC* |
|-----------|---------|-----------|-------|
| 0R4       | 0.4     | B,C       | 1000  |
| 0R5       | 0.5     | B,C,D     | 1000  |
| 0R6       | 0.6     | "         | 1000  |
| 0R7       | 0.7     | "         | 1000  |
| 0R8       | 0.8     | "         | 1000  |
| 0R9       | 0.9     | "         | 1000  |
| 1R0       | 1.0     | "         | 1000  |
| 1R1       | 1.1     | "         | 1000  |
| 1R2       | 1.2     | "         | 1000  |
| 1R3       | 1.3     | "         | 1000  |
| 1R4       | 1.4     | "         | 1000  |
| 1R5       | 1.5     | "         | 1000  |
| 1R6       | 1.6     | "         | 1000  |
| 1R7       | 1.7     | "         | 1000  |
| 1R8       | 1.8     | "         | 1000  |
| 1R9       | 1.9     | "         | 1000  |
| 2R0       | 2.0     | "         | 1000  |
| 2R1       | 2.1     | "         | 1000  |
| 2R2       | 2.2     | "         | 1000  |
| 2R4       | 2.4     | "         | 1000  |
| 2R7       | 2.7     | "         | 1000  |
| 3R0       | 3.0     | "         | 1000  |
| 3R3       | 3.3     | "         | 1000  |
| 3R6       | 3.6     | "         | 1000  |
| 3R9       | 3.9     | "         | 1000  |

\*@ 125°C

| Cap. Code | Cap. pF | Cap. Tol. | WVDC* |
|-----------|---------|-----------|-------|
| 4R3       | 4.3     | B,C,D     | 1000  |
| 4R7       | 4.7     | "         | 1000  |
| 5R1       | 5.1     | "         | 1000  |
| 5R6       | 5.6     | "         | 1000  |
| 6R2       | 6.2     | "         | 1000  |
| 6R8       | 6.8     | B,C,J,K,M | 1000  |
| 7R5       | 7.5     | "         | 1000  |
| 8R2       | 8.2     | "         | 1000  |
| 9R1       | 9.1     | "         | 1000  |
| 100       | 10      | F,G,J,K,M | 500   |
| 110       | 11      | "         | 500   |
| 120       | 12      | "         | 500   |
| 130       | 13      | "         | 500   |
| 150       | 15      | "         | 500   |
| 160       | 16      | "         | 500   |
| 180       | 18      | "         | 500   |
| 200       | 20      | "         | 500   |
| 220       | 22      | "         | 500   |
| 240       | 24      | "         | 500   |
| 270       | 27      | "         | 500   |
| 300       | 30      | "         | 500   |
| 330       | 33      | "         | 500   |
| 360       | 36      | "         | 500   |
| 390       | 39      | "         | 500   |
| 430       | 43      | "         | 500   |

\*@ 125°C

| Cap. Code | Cap. pF | Cap. Tol. | WVDC* |
|-----------|---------|-----------|-------|
| 470       | 47      | F,G,J,K,M | 300   |
| 510       | 51      | "         | 300   |
| 560       | 56      | "         | 300   |
| 620       | 62      | "         | 300   |
| 680       | 68      | "         | 100   |
| 750       | 75      | "         | 100   |
| 820       | 82      | "         | 100   |
| 910       | 91      | "         | 100   |
| 101       | 100     | "         | 100   |

\*@ 125°C

### SPECIFICATIONS

|                                     |  |
|-------------------------------------|--|
| <b>Dissipation Factor</b>           | MA/MB 18/28; 0.05% maximum<br>MA 58/68; 0.15% maximum @ 1.0VRMS (f = 1 MHz)<br>MA 78/88; 2.5% maximum @ 1.0VRMS maximum (f = 1kHz)   |
| <b>Temperature Coefficient</b>      | MB28 Series P90±30ppm/°C, (-55°C to +175°C)<br>MA 18/28 Series P90 ±20ppm/°C, (-55°C to +125°C)<br>MA 58/68 Series; COG (0 ±30ppm/°C, -55°C to +125°C)<br>MA 78/88 Series; ±15% maximum (-55°C to +125°C)  |
| <b>Insulation Resistance</b>        | MA/MB 18/28 1000K M Ohms at +25°C, 100K M Ohms at +125°C<br>MA 58/68 1000K M Ohms at +25°C, 100K M Ohms at +125°C<br>MA 78/88 100K M Ohms or 1000 M Ohm µF min., whichever is less (@ 25°C)<br>10K M Ohms or 100 M Ohms µF min., whichever is less (@ 125°C) |
| <b>Dielectric Test Voltage</b>      | MA/MB 18/28/58/68/78/88, 250% of WVDC for 5 seconds  |
| <b>Capacitance Drift</b>            | Meets or Exceeds MIL-PRF-55681 (Does not apply for MA 78/88)   |
| <b>Aging</b>                        | Negligible for MA/MB 18/28/58/68, MA 78/88; 2.5% per decade maximum  |
| <b>Environmental Tests</b>          | MIL-STD-202  |
| <b>Shock</b>                        | Method 213, Condition J  |
| <b>Vibration</b>                    | Method 204, Condition B  |
| <b>Moisture Resistance</b>          | Method 106   |
| <b>Solderability</b>                | Method 208   |
| <b>Immersion</b>                    | Method 104, Condition B  |
| <b>Barometric Pressure</b>          | Method 105, Condition B  |
| <b>Resistance to Soldering Heat</b> | Method 210, Condition B  |
| <b>Thermal Shock</b>                | Method 107, Condition A  |
| <b>Life</b>                         | Method 108, Condition F  |
| <b>Marking</b>                      | Standard MA/MB product is unmarked   |

APPLICATION SPECIFIC  
CAPACITORS

### TAPE AND REEL PACKAGING

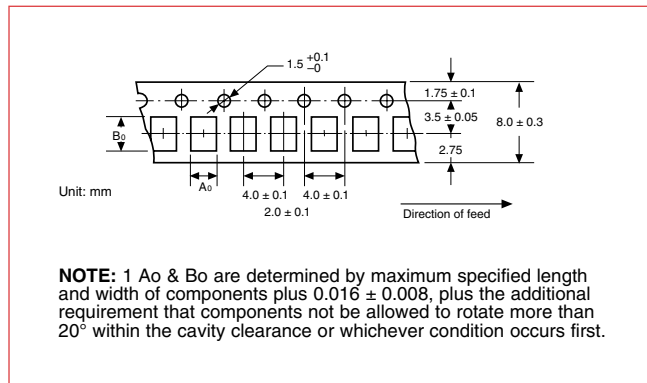

### DIMENSIONS: mm

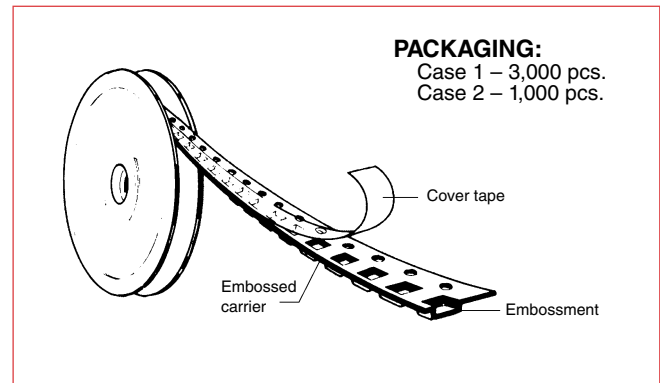

### CONDUCTIVE TAPE

| Advantages            | Benefits  |
|-----------------------|---|
| Conductive            | Prevents static charge build-up                     |
| Flexibility           | Insures against crazing, cracking and brittleness   |
| Dimensional strength  | Drive loading will not elongate sprocket holes      |
| Dimensional stability | Smooth, reliable running on pick and place machines |

Other packaging options available — Consult Factory

### ELECTRICAL PROPERTIES

| Property                                | Value                          | Test Method |
|---|--------------------------------|-------------|
| Resistivity                             | 5 x 10 <sup>5</sup> ohm/square | ASTM D-257  |
| Electrostatic Decay Time At 50% RH@21°C | 0.01 Sec.                      | ASTM D-257  |

Typical Values