

Phase-out/Discontinued

**N-CHANNEL POWER MOS FET ARRAY
SWITCHING TYPE**

DESCRIPTION

The μPA1572 is N-channel Power MOS FET Array that built in 4 circuits designed for solenoid, motor and lamp driver.

FEATURES

- 4 V driving is possible
- Large Current and Low On-state Resistance
 $I_{D(pulse)} = \pm 6 \text{ A}$
 $R_{DS(on)} \leq 0.60 \Omega \text{ MAX. (} V_{GS} = 10 \text{ V)}$
 $R_{DS(on)} \leq 0.80 \Omega \text{ MAX. (} V_{GS} = 4 \text{ V)}$
- 2.54 mm Pitch (0.1 inch)

ORDERING INFORMATION

Part Number	Package	Quality Grade
μPA1572H	10 pin SIP	Standard

Please refer to "Quality grade on NEC Semiconductor Devices" (Document number IEI-1209) published by NEC Corporation to know the specification of quality grade on the devices and its recommended applications.

ABSOLUTE MAXIMUM RATINGS (T_a = 25 °C)

Drain to Source Voltage	V _{bss}	60	V
Gate to Source Voltage	V _{gss}	±20	V
Drain Current (DC)	I _{D(DC)}	±2.0	A/unit
Drain Current (pulse)	I _{D(pulse)*}	±6.0	A/unit
Total Power Dissipation (4 circuits)			
	<T _c = 25 °C> P _{T1}	28	W
Total Power Dissipation (4 circuits)			
	<T _a = 25 °C> P _{T2}	3.5	W
Storage Temperature	T _{stg}	-55 to +150	°C
Junction Temperature	T _j	150	°C

* PW ≤ 300 μs, Duty Cycle ≤ 10 %

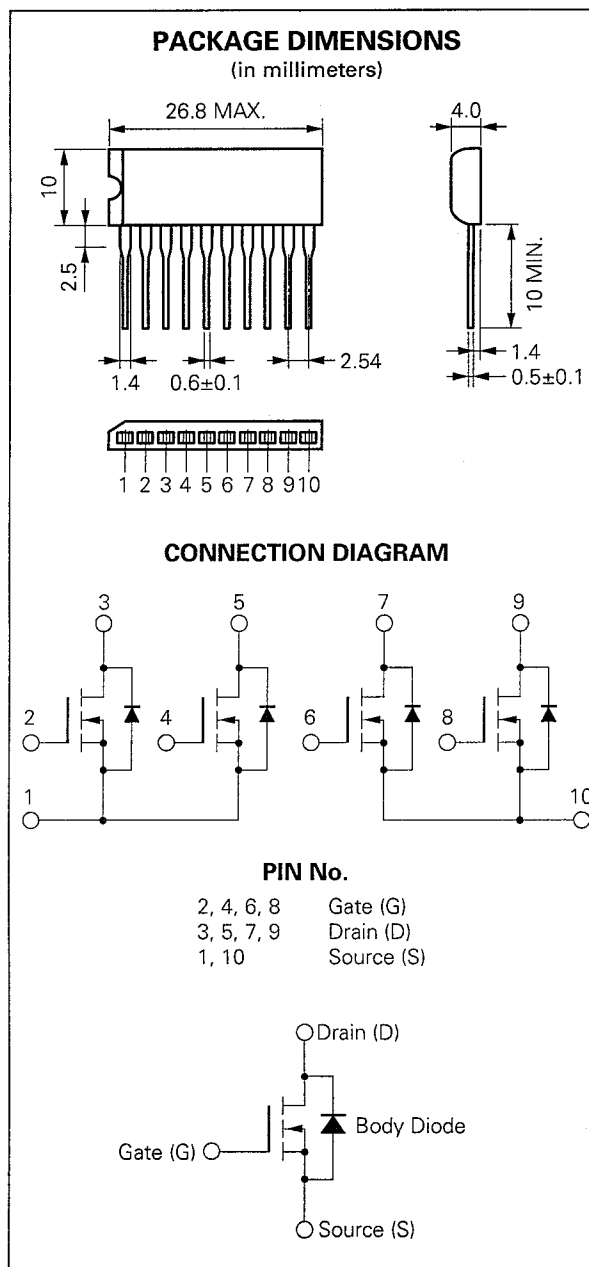

ELECTRICAL CHARACTERISTICS (T_a = 25 °C)

CHARACTERISTIC	SYMBOL	MIN.	TYP.	MAX.	UNIT	TEST CONDITIONS
Drain Leakage Current	I _{DSS}			10	μA	V _{DS} = 60 V, V _{GS} = 0
Gate to Source Leakage Current	I _{GSS}			±100	nA	V _{GS} = ±20 V, V _{DS} = 0
Gate to Source Cutoff Voltage	V _{GS(off)}	1.0		2.5	V	V _{DS} = 10 V, I _D = 1 mA
Forward Transfer Admittance	y _{fs}	1.0			S	V _{DS} = 10 V, I _D = 1 A
Drain to Source On-state Resistance	R _{DSON1}		0.4	0.6	Ω	V _{GS} = 10 V, I _D = 1 A
Drain to Source On-state Resistance	R _{DSON2}		0.6	0.8	Ω	V _{GS} = 4 V, I _D = 1.0 A
Input Capacitance	C _{iss}		200		pF	V _{DS} = 10 V V _{GS} = 0 f = 1.0 MHz
Output Capacitance	C _{oss}		70		pF	
Reverse Transfer Capacitance	C _{rss}		15		pF	
Turn-On Delay Time	t _{d(on)}		45		ns	I _D = 1 A V _{GS} = 10 V V _{CC} = 50 V R _L = 50 Ω, R _{in} = 10 Ω See Fig. 1
Rise Time	t _r		40		ns	
Turn-Off Delay Time	t _{d(off)}		450		ns	
Fall Time	t _f		110		ns	

Fig. 1 Switching Time Test Circuit

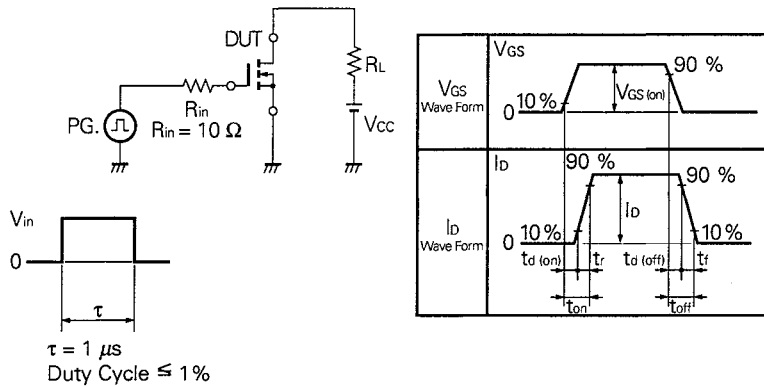

TYPICAL CHARACTERISTICS (T_a = 25 °C)

TOTAL POWER DISSIPATION vs. AMBIENT TEMPERATURE

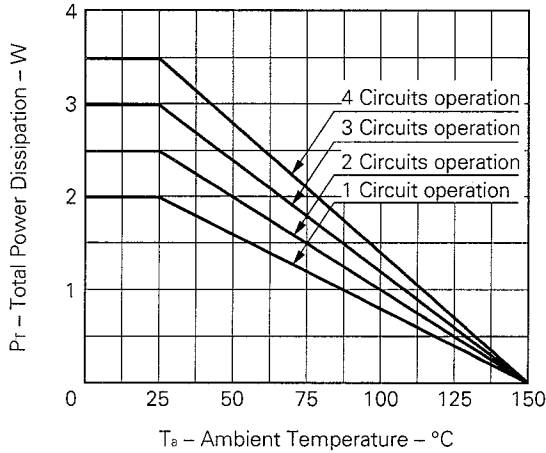

TOTAL POWER DISSIPATION vs. CASE TEMPERATURE

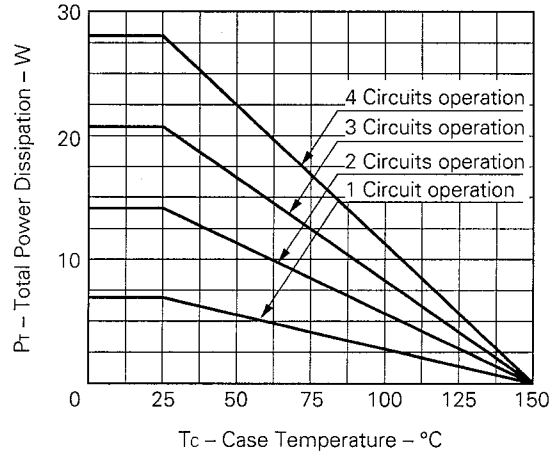

DERATING CURVE OF SAFE OPERATING AREA

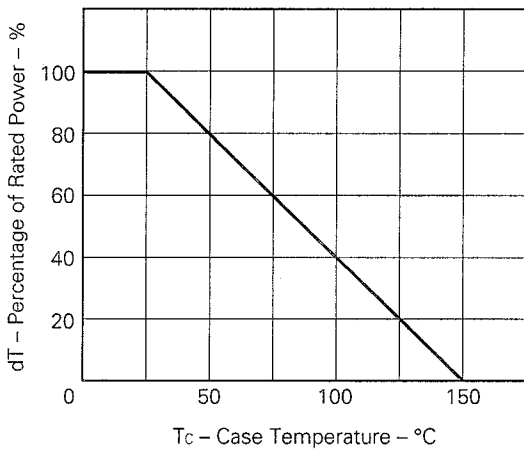

FORWARD BIAS SAFE OPERATING AREA

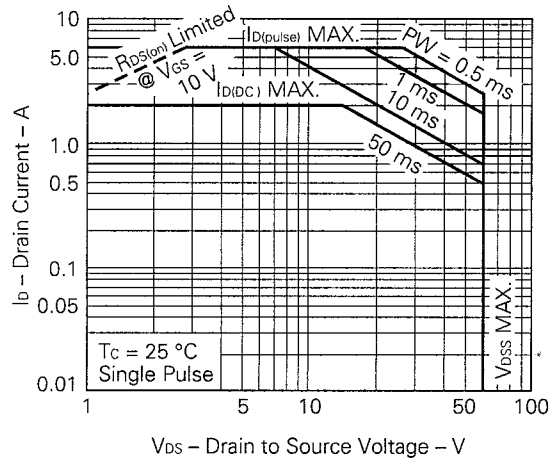

DRAIN CURRENT vs. DRAIN TO SOURCE VOLTAGE

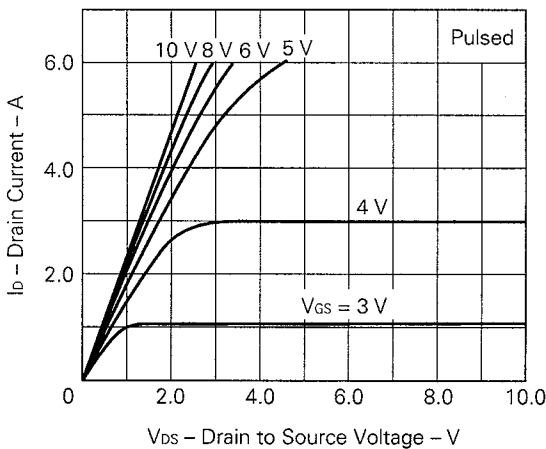

FORWARD TRANSFER ADMITTANCE vs. DRAIN CURRENT

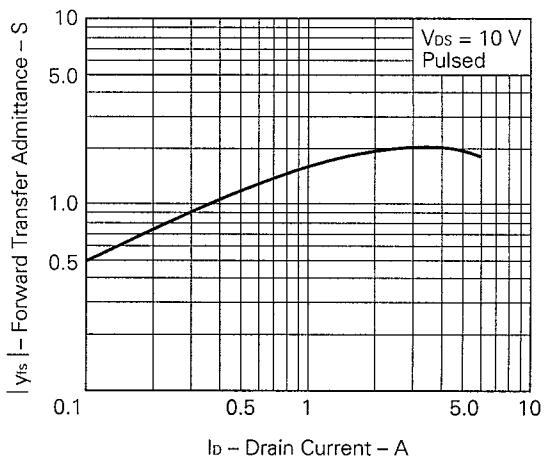

SOURCE TO DRAIN DIODE FORWARD VOLTAGE

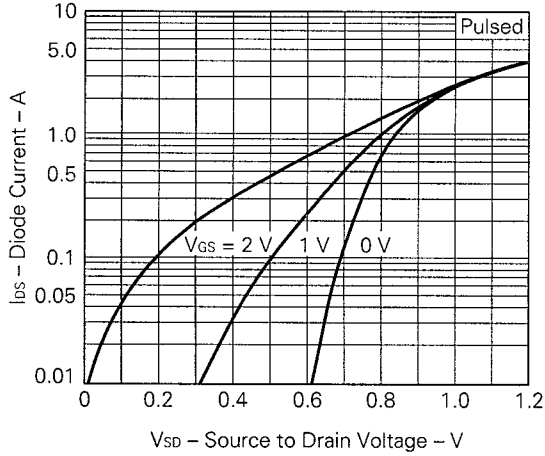

CAPACITANCE vs. DRAIN TO SOURCE VOLTAGE

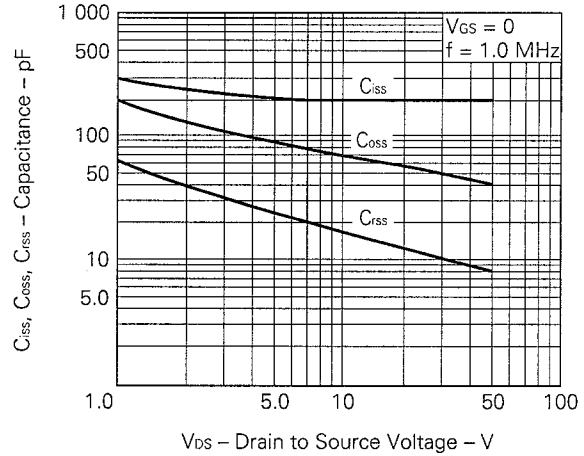

DRAIN TO SOURCE ON-STATE RESISTANCE vs. GATE TO SOURCE VOLTAGE

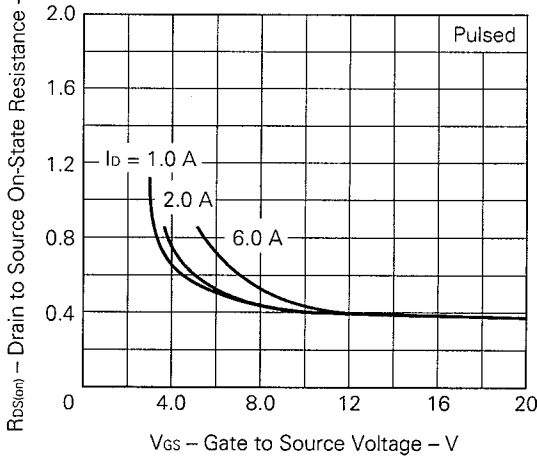

DRAIN TO SOURCE ON-STATE RESISTANCE vs. CHANNEL TEMPERATURE

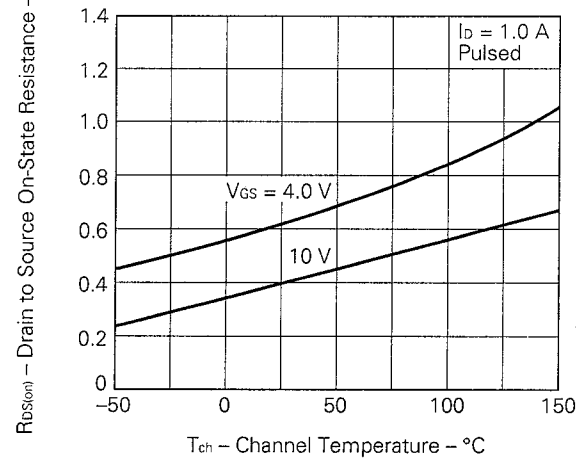

DRAIN TO SOURCE ON-STATE RESISTANCE vs. DRAIN CURRENT

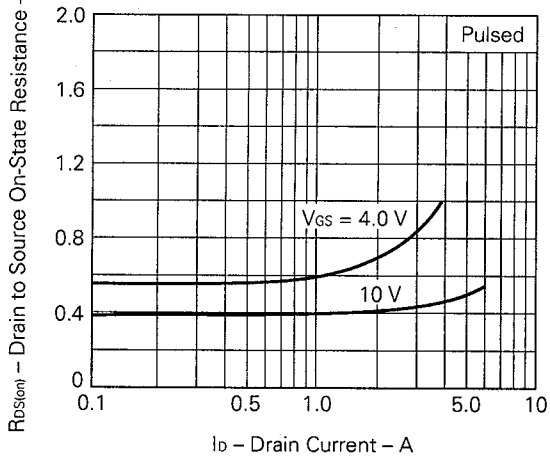

TRANSFER CHARACTERISTICS

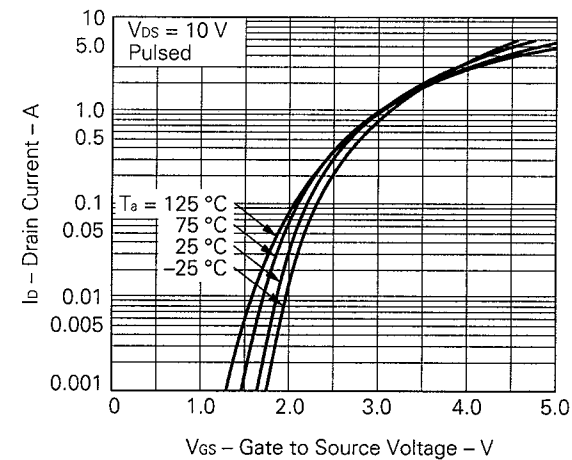

GATE TO SOURCE CUTOFF VOLTAGE vs. CHANNEL TEMPERATURE

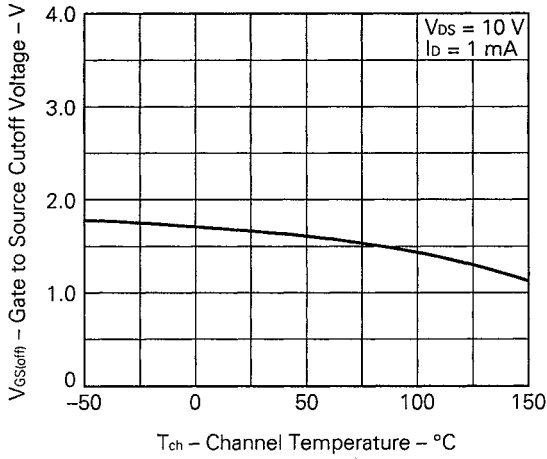

SWITCHING TIME vs. DRAIN CURRENT

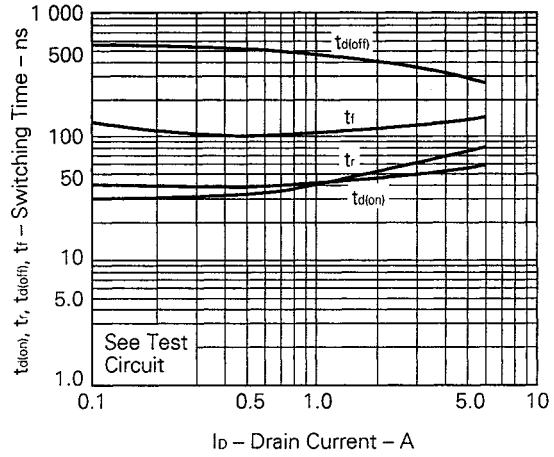

Reference

Document name	Document No.
Quality control of NEC semiconductors devices.	TEI-1202
Quality control guide of semiconductors devices.	MEI-1202
Assembly manual of semiconductors devices.	IEI-1207
Safe operating area of Power MOS FET	TEA-1034
Appication circuit using Power MOS FET	TEA-1035

[MEMO]

No part of this document may be copied or reproduced in any form or by any means without the prior written consent of NEC Corporation. NEC Corporation assumes no responsibility for any errors which may appear in this document.

NEC Corporation does not assume any liability for infringement of patents, copyrights or other intellectual property rights of third parties by or arising from use of a device described herein or any other liability arising from use of such device. No license, either express, implied or otherwise, is granted under any patents, copyrights or other intellectual property rights of NEC Corporation or others.

The devices listed in this document are not suitable for use in aerospace equipment, submarine cables, nuclear reactor control systems and life support systems. If customers intend to use NEC devices for above applications or they intend to use "Standard" quality grade NEC devices for applications not intended by NEC, please contact our sales people in advance.

Application examples recommended by NEC Corporation.

Standard: Computer, Office equipment, Communication equipment, Test and Measurement equipment, Machine tools, Industrial robots, Audio and Visual equipment, Other consumer products, etc.

Special: Automotive and Transportation equipment, Traffic control systems, Antidisaster systems, Anticrime systems, etc.