

DESCRIPTION

Designed to support DDR1, DDR2 and DDR3 SDRAM memory power requirements, the VCN60/70 Series point-of-load, non-isolated DC/DC converters have the high performance and flexibility required by a wide variety of applications including computing and office equipment, telecommunications hardware, industrial automation and test equipment.

These high efficiency (88% typ.), high current SIP's feature a programmable wide output range which is suitable for powering ASICs, FPGAs, DSPs and other types of ICs. The use of integrated drivers and switching devices allows the VCN60/70 Series to switch at high frequency, providing high bandwidth and high current density (50A/in³) in a 1U form factor without sacrificing efficiency.

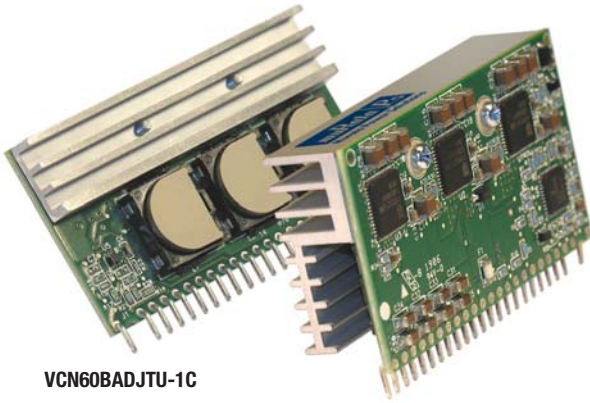

VCN60BADJTU-1C

VCN70BADJTU-1C

FEATURES

- Supports Double Data Rate SDRAM specifications DDR1, 2, 3 and similar requirements
- Programmable output voltage
- Soft start circuit
- Over-voltage protection
- Over-current protection
- Over-temperature protection
- Differential remote sense
- Power good signal
- Output enable
- High efficiency
- "1U" height
- Pre-bias turn on
- Fused input

SELECTION GUIDE

Order Code	Nominal Input Voltage (V)	Output Current (A)	Output Voltage	Mounting Type	Form Factor
VCN60BADJTU-1C	12	60	Adjustable	Thru-hole	1U
VCN70BADJTU-1C	12	70	Adjustable	Thru-hole	1U

INPUT CHARACTERISTICS

Parameter	Conditions	MIN.	TYP.	MAX.	Units
Input voltage operating range		10.2	12	13.2	Vdc
Turn ON threshold	V _{IN} rising		9.7		
Turn OFF threshold	V _{IN} falling		8.7		
Maximum input current	1.80V _{OUT} @ 70A/12V _{IN}		12		A
No-load input current	1.80V _{OUT}			330	mA
Disabled input current			50		
Input reflected ripple current	1.80V _{OUT} @ 70A/13.2V _{IN}		100		mA RMS
Recommended External Input Capacitance¹	OSCON type or equivalent	270			μF

OUTPUT CHARACTERISTICS

Parameter	Conditions	MIN.	TYP.	MAX.	Units
Voltage set point	Programmable	0.6		3.5	V
Line regulation	1.2V _{OUT}			+/- 0.1	%
Load regulation	1.2V _{OUT}			+/- 0.2	
Initial setpoint accuracy	0.1% trim resistor @ 1.2V		0.5	+/- 1.0	
Ripple & noise	20MHz bandwidth		25		mV p-p
Current operating range	140W max output	0		70	A
Efficiency @ 60Amp Load	100% load 12V _{IN} , 1.8V _{OUT}		88		%
Turn-on time				10	mS
Remote sense compensation				10	%V _o nom
Required External Output Capacitance²	Setpoint dependent	560			μF
Transient Response³	1A / μS			+/- 3	%
	0.5A / μS			+/- 2	

1. No capacitor needed for Input Ripple Current capability. The voltage rating on the external caps should be twice the expected maximum working voltage.
2. Characterized with low ESR output capacitors, such as United Chemi-Con 4PS560MH11, Fujitsu FP-4R0RE561M-S1R, Sanyo OSCON 4SP560M. Setpoints of 1V and lower require three capacitors, with a maximum of 4000μF. Setpoints of 1.2V and 1.5V require two capacitors, with a maximum of 4000μF. Setpoints of 1.8V and higher require one capacitor, with the maximum allowed capacitance of 4000μF up to 2V and 2300μF maximum at above 2V. The voltage rating on the external caps should be twice the expected maximum working voltage.
3. Load steps from 30-60A for 1.8V and lower set points. 20-40A for 2.5V and 3.3V setpoints.



GENERAL CHARACTERISTICS					
Parameter	Conditions	MIN.	TYP.	MAX.	Units
Enable input	LOW = disable			0.8	Vdc
	HIGH = enable	1.7		6.0	
Power good input	LOW = fault (Imax = 4mA)			0.4	
	HIGH = good (open drain with ESD clamp)			5.3	
Storage temperature		-40		70	°C
Operating temperature		0		70	
Material flammability	UL 94V-0				
MTBF	Calculated (RAC PRISM ⁴ @ 40°C 1.8V @ 50A)		4.3		x10 ⁶ Hrs
Switching frequency	Per phase		450		KHz
Dimensions ⁵	VCN60 2.4"L x 0.375"W x 1.25"H (60.96 mm x 9.525 mm x 31.75 mm)				
	VCN70 2.4"L x 0.660"W x 1.25"H (60.96 mm x 16.764 mm x 31.75 mm)				

⁴ PRISM is a standard for MTBF prediction and system reliability analysis, originally developed by the Reliability Analysis Center (RAC).

⁵ Width is a maximum dimension.

PROTECTION CHARACTERISTICS					
Parameter	Conditions	MIN.	TYP.	MAX.	Units
Output current limit	Hiccup mode		95		A
Overvoltage shutdown	Latching		116		%V _{NOM}
Input fusing			20		A

NOTES

V_{IN} = 12Vdc, T_A = 25°C, Airflow = 400LFM unless otherwise noted. Specifications subject to change without notice.

OUTPUT VOLTAGE SETPOINT ADJUSTMENT

The following relationship establishes the calculation of external resistors:

$$R_{ADJ} (k\Omega) = \frac{1.2}{(V_{OUT} - 0.6)}$$

For V_{OUT} setting an external resistor is connected between the R_{TRIM} pin and – Sense pin.

Typical Efficiency Curve (12V_{IN}, 25°C)

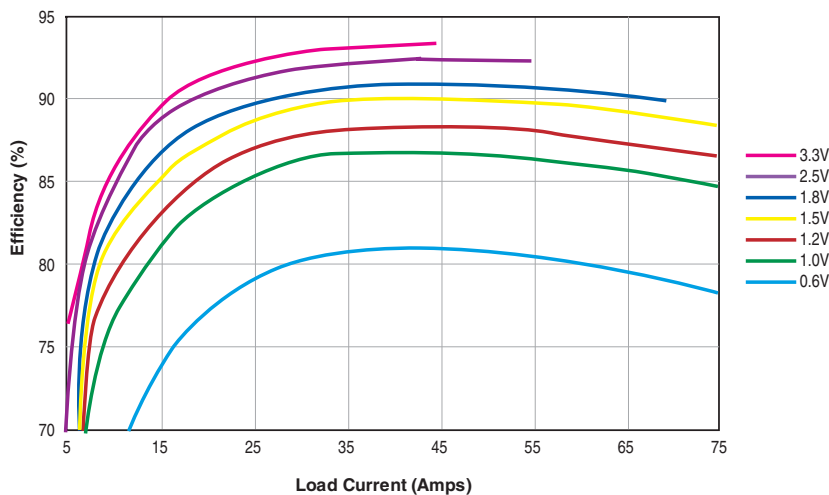

Thermal Derating Curves for the 60 Amp rated VCN60BADJTU-1C

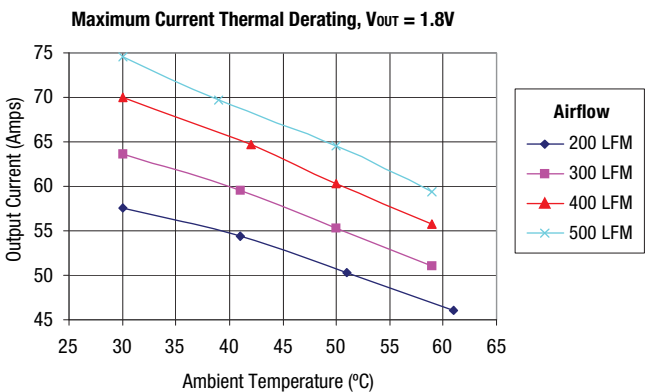
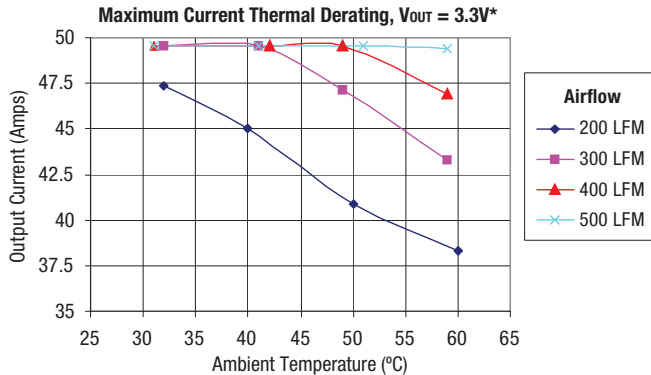
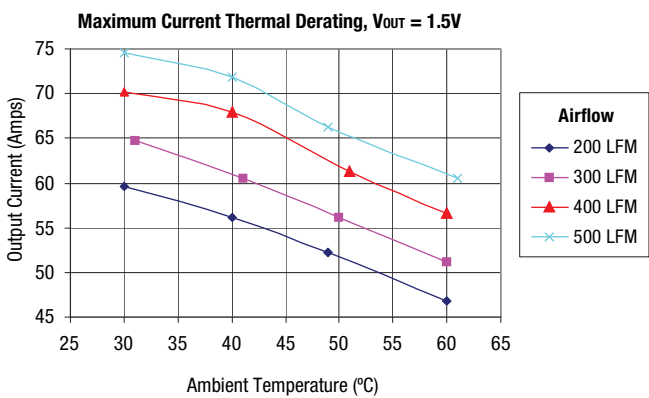
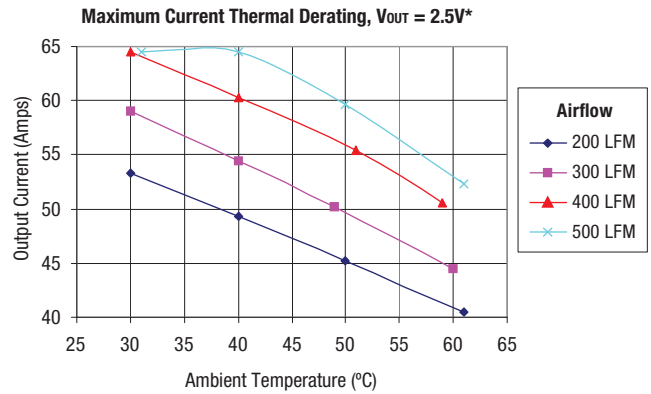
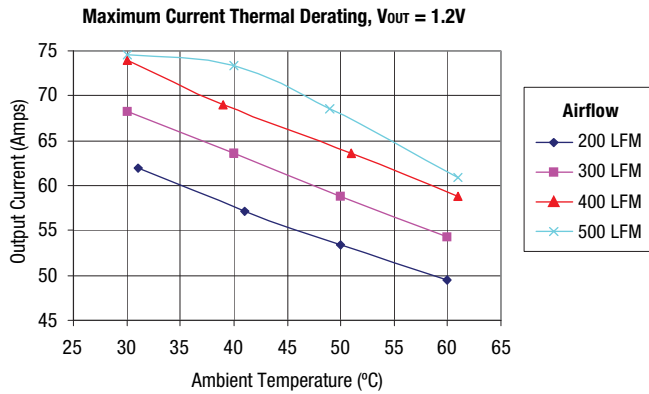

The table shows the appropriate derated output current for running the unit at 70°C ambient temperature and respective airflows.

VCN60BADJTU-1C DERATED OUTPUT CURRENT (AMPS) AT 70°C AMBIENT					
	1.2V	1.5V	1.8V	2.5V*	3.3V*
300LFM	49.6	47.3	46.0	40.5	37.5
400LFM	52.0	50.3	49.0	43.5	40.5
500LFM	55.0	53.0	51.3	47.0	43.3

* I_{OUT} loads in excess of ~140W are possible at higher V_{OUT} settings (>2V), if proper Thermal Derating is maintained, and if V_{IN} is high enough to limit input current to below 15A in the 20A rated on board input fuse.

Thermal Derating Curves for the 70 Amp rated VCN70BADJTU-1C

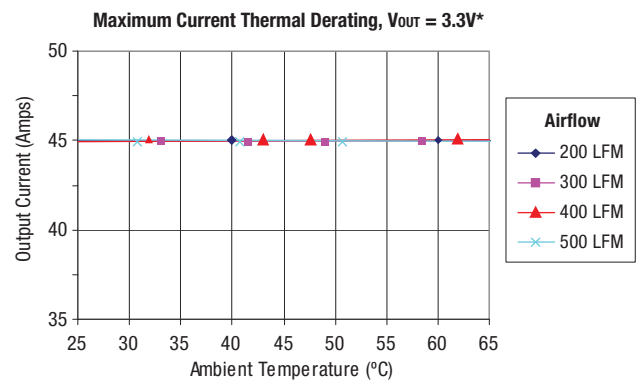
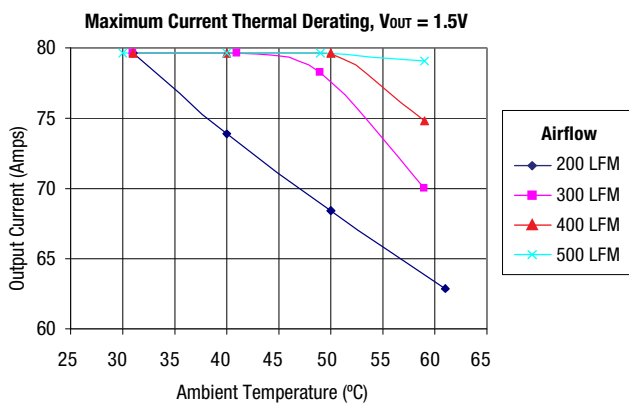
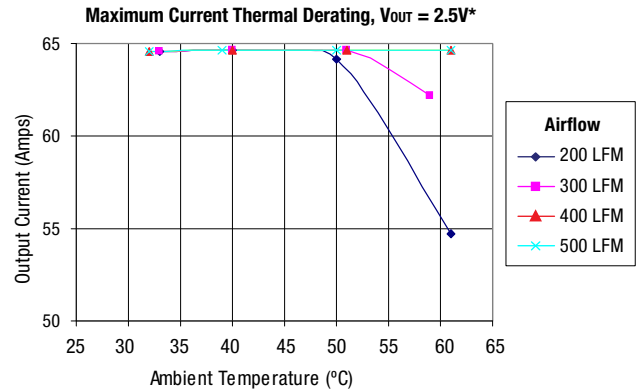
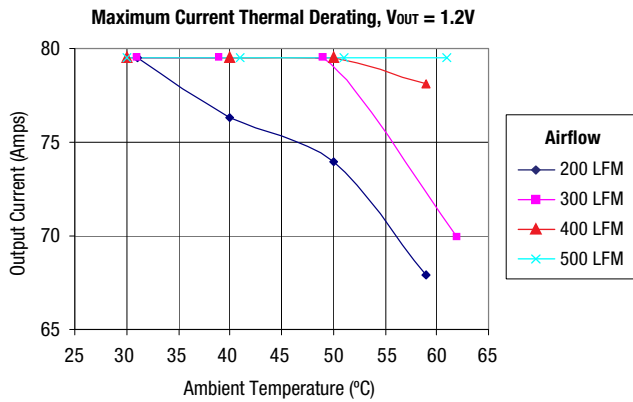

Note:
For the 3.3V model, the maximum output current at 3.3V is 45A due to input current limitations.

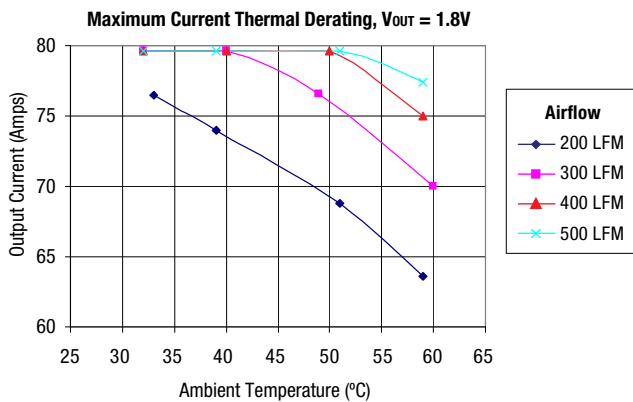

The table shows the appropriate derated output current for running the unit at 70°C ambient temperature and respective airflows.

VCN70BADJTU-1C DERATED OUTPUT CURRENT (AMPS) AT 70°C AMBIENT					
	1.2V	1.5V	1.8V	2.5V*	3.3V*
300LFM	59.6	57.6	57.0	53.6	45.0
400LFM	63.6	62.1	61.1	57.6	45.0
500LFM	67.9	65.6	64.6	61.6	45.0

* I_o output loads in excess of ~140W are possible at higher V_{out} settings (>2V), if proper Thermal Derating is maintained, and if V_{in} is high enough to limit input current to below 15A in the 20A rated on board input fuse.

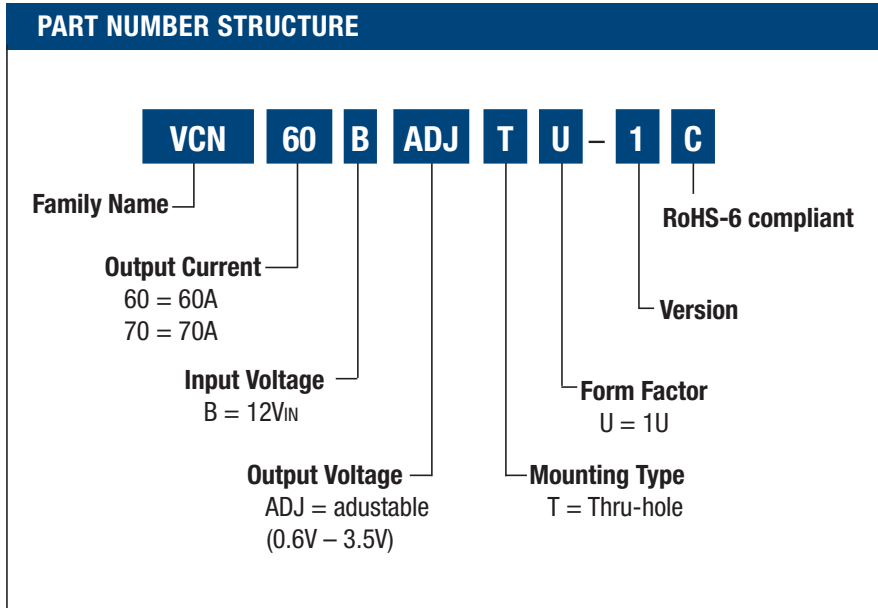

PIN ASSIGNMENT*			
Pin	Function	Pin	Function
1	Trim	13	12V input
2	KEY	14	12V input
3	VSS	15	V _{OUT}
4	PWRGD	16	V _{OUT}
5	Reserved	17	V _{SS}
6	Reserved	18	V _{OUT}
7	V _{SS}	19	V _{SS}
8	V _{SS}	20	V _{OUT}
9	OUTEN	21	V _{SS}
10	-SENSE	22	V _{OUT}
11	+SENSE	23	V _{SS}
12	12V input	24	V _{OUT}

* Because of the high currents, connect all identical signals in parallel with adequate PC board etch. Connect the +Sense pin to the V_{OUT} connection at the load. Connect the -Sense pin to the V_{SS} pin at the load. If the Sense pins are not used, connect them to their respective +V_{OUT} and V_{SS} pins at the converter.

MECHANICAL SPECIFICATIONS FOR THE VCN60BADJTU-1C

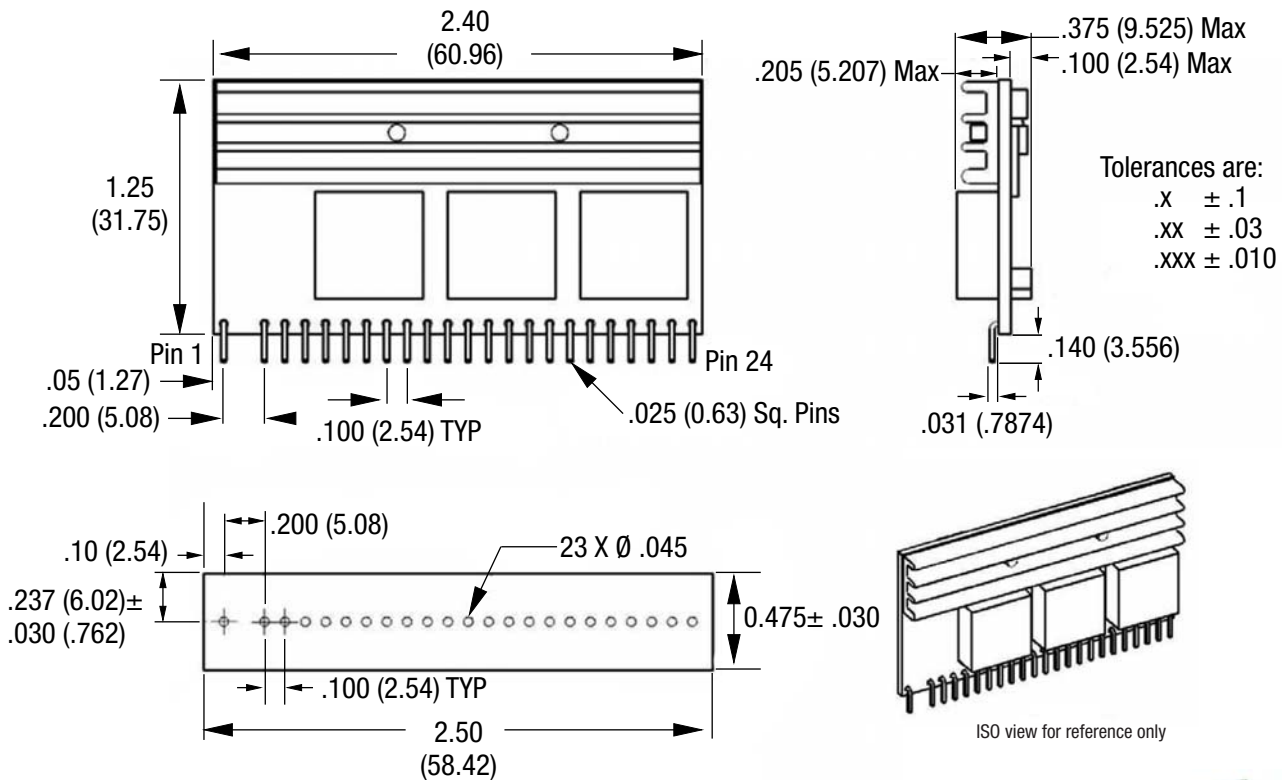

Recommended area to be free of components

All dimensions are in inches (mm).

RoHS COMPLIANCY

The VCN60BADJTU-1C and VCN70BADJTU-1C are in compliance with the European Union Directive 2002/95/EC (RoHS) with respect to the following substances:

- lead (Pb)
- cadmium (Cd)
- mercury (Hg)
- hexavalent chromium
- polybrominated biphenyls (PBB)
- polybrominated diphenyl ethers (PBDE)

RoHS PROCESS NOTE

These products are not intended to go through a reflow solder process. Use wave solder, selective solder or hand solder process with a peak temperature of 260°C for 10 seconds.

MECHANICAL SPECIFICATIONS FOR THE VCN70BADJTU-1C

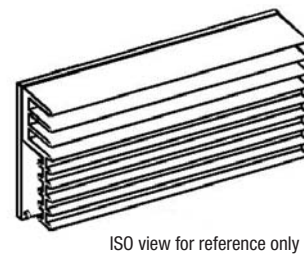
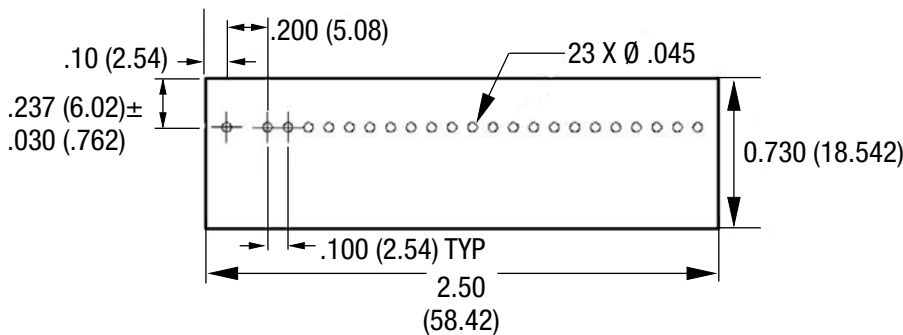
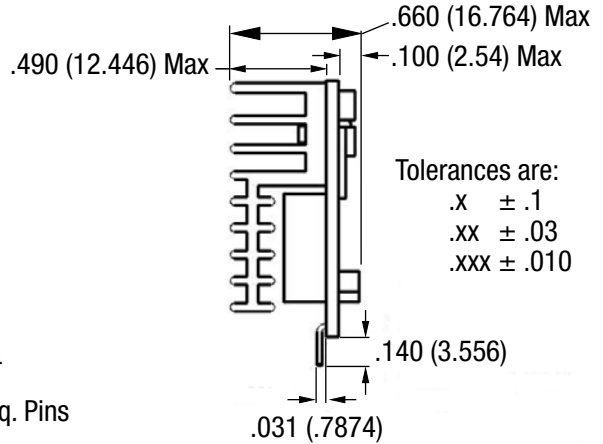
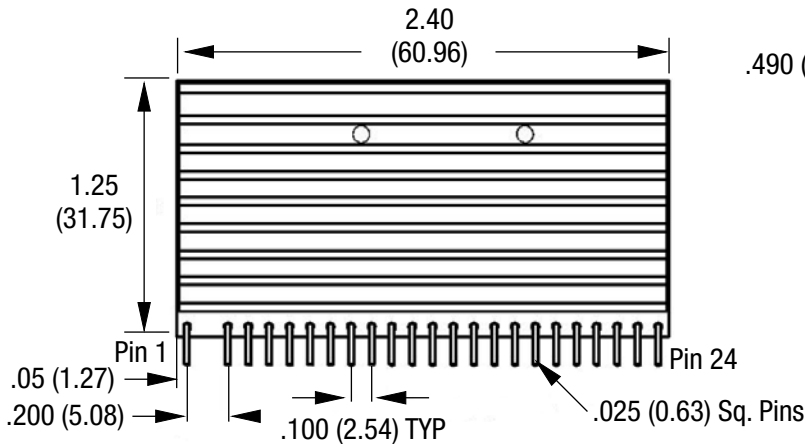

Recommended area to be free of components
 All dimensions are in inches (mm).

Murata Power Solutions, Inc.
 11 Cabot Boulevard, Mansfield, MA 02048-1151 U.S.A.
 Tel: (508) 339-3000 (800) 233-2765 Fax: (508) 339-6356
www.murata-ps.com email: sales@murata-ps.com
 ISO 9001 REGISTERED

1/30/08

Murata Power Solutions, Inc. makes no representation that the use of its products in the circuits described herein, or the use of other technical information contained herein, will not infringe upon existing or future patent rights. The descriptions contained herein do not imply the granting of licenses to make, use, or sell equipment constructed in accordance therewith. Specifications are subject to change without notice.
 © 2008 Murata Power Solutions, Inc.

- USA:** Tucson (AZ), Tel: (800) 547 2537, email: sales@murata-ps.com
- Canada:** Toronto, Tel: (866) 740 1232, email: toronto@murata-ps.com
- UK:** Milton Keynes, Tel: +44 (0)1908 615232, email: mk@murata-ps.com
- France:** Montigny Le Bretonneux, Tel: +33 (0)1 34 60 01 01, email: france@murata-ps.com
- Germany:** München, Tel: +49 (0)89-544334-0, email: ped.munich@murata-ps.com
- Japan:** Tokyo, Tel: 3-3779-1031, email: sales_tokyo@murata-ps.com
 Osaka, Tel: 6-6354-2025, email: sales_osaka@murata-ps.com
Website: www.cd4power.jp
- China:** Shanghai, Tel: +86 215 027 3678, email: shanghai@murata-ps.com
 Guangzhou, Tel: +86 208 221 8066, email: guangzhou@murata-ps.com