



# Thermatel® Enhanced Model TA2 Thermal Mass Flow Meter

## DESCRIPTION

The Thermatel® Enhanced Model TA2 Thermal Mass Flow Meter provides reliable mass measurement for air and gas flow applications. The powerful, yet easy to use, electronics are contained in a compact explosion proof enclosure. The TA2 is available with both insertion probes as well as flow body design for smaller pipe sizes. The TA2 offers excellent performance at an exceptional value.

## TECHNOLOGY FEATURES

- Direct mass flow measurement of air and gases
- High turndown ratios
- Excellent low flow sensitivity
- Low pressure drop
- NIST traceable calibrations

## ELECTRONICS FEATURES

- Compact explosion proof/NEMA 4X enclosure, mounted either integrally on the probe or at a remote location
- Accepts all input power—11.6 to 30 VDC and 100 to 264 VAC
- 4–20 mA flow signal can be set for either active or passive operation
- Optional pulse output plus second mA output which can be used for temperature or different flow range (mA output passive connection only)
- HART communications with AMS and DTMs available
- 2-line × 16-character backlit display with four push-buttons for ease of configuration
- Rotatable housing
- Calibration for two different gases
- Language selections of English, German, French, Spanish, and Russian



## PROBE FEATURES

- All 316 welded stainless steel and Hastelloy® C-276 construction
- Selection of process connections, including threads, welded flange construction, and use with a compression fitting
- Process temperatures up to +400° F (+200° C)
- Pressure rating to 1500 psig (103 bar) dependent upon process connections
- Probe can be field-replaced
- Unique sensor design permits higher mass flow rates yet maintains equivalent thermal mass for varying temperature operation
- Optional hot tap retractable probe assembly

## APPLICATIONS

- Combustion air
- Compressed air
- Natural gas
- Aeration air
- Digester/Bio-gas
- Vent lines/Flare headers
- Hydrogen lines

## FLOW BODY FEATURES

---

- ½" to 4" pipe sizes
- NPT threads available up to 2" in size
- Stainless steel and carbon steel (with stainless steel sensor) construction
- Flange connections for all sizes
- Optional stainless steel flow conditioning plate for 1.5" and higher
- Flow conditioning for ½" to 1" based on upstream length and sensor design



## ADDITIONAL FEATURES

---

### TOTALIZER

Two 7-digit flow totalizers, one resettable and one non-resettable are provided. Flow units selectable in user's choice of engineering units. Totalizer data is electronically stored eliminating the need for backup batteries and provides maximum safeguard data in the event of a power interruption. The totalizer can be reset using the display module, HART or via *PACTware™*.

### TEMPERATURE COMPENSATION

Thermal flow technology measures the mass flow rate without the need for pressure and temperature correction as required with most gas flow instruments that measure the flow rate at actual conditions. However, changing temperature will change the properties of the gas which effect convective heat transfer. The Model TA2 measures the gas temperature and automatically adjusts the mass flow measurement for changes in gas properties over the entire temperature range of the instrument.

### DIAGNOSTICS

Diagnostics is an important aspect of the TA2. The Enhanced TA2 has additional diagnostics to check the operation and performance of the unit. Diagnostics includes probe status, a test of RTD drift with automatic recalibration, and overall performance.

In order to verify that the calibration and configuration match the original calibration conditions, the user can select a specific signal and compare the TA2 display value against the original calibration certificate.

### LOW VOLTAGE OPERATION

The TA2 will accept input power as low as 11.6 VDC on Explosion Proof units when used with Integral Electronics.

### SELECTABLE STP CONDITIONS

The TA2 directly measures mass flow of the gas referenced to Standard Temperature and Pressure (STP) conditions. Software permits the user to change STP conditions for their own requirements.

### AREA COMPENSATION FOR PIPE SIZE

The TA2 automatically compensates the flow measurement based on actual area of the pipe. The user simply enters the size or the area of the new pipe, and the instrument automatically calculates the flow including factors for the probe blockage.

### HART COMMUNICATION

Using HART/AMS communication, the user can configure the instrument from a remote location. HART provides the same functionality as the display module interface including all configuration and diagnostic information.

### AIR EQUIVALENCY

Using historic air-gas calibration data, an air equivalency calibration can be performed on select gases. Consult Magnetrol® for details and flow ranges.

## ADDITIONAL FEATURES continued

### PROBE INSTALLATION

Probes can be provided with a variety of process connections, including threads, flanges, or installation through a compression fitting. The sensor will fit pipe sizes of 1½" diameter or larger (2" minimum size with thread connection).

The sensor is protected to prevent damage due to "bottoming-out" if inserted too far into a pipe.

### PULSE OUTPUT

The optional pulse output provides a pulse output equivalent to user selected units and multiplier factor. Both active (power from the TA2) or passive (external power supply) connections are provided to match the user's interface. This output can optionally be used as an alarm to indicate that the flow rate is above or below the desired set point.

### PORTABLE DISPLAY MODULE

A portable display module for configuration and diagnosis of multiple units is available (part number 089-5219-002). This portable module plugs into the electronics in the same manner as the normal display and uses the same software menu. This module permits the user to reduce installation cost by having one display module with keypad for multiple TA2 units.

Usage of the display module requires that the housing cover be removed during use and thus may not be useable in hazardous areas. In these cases, the HART option should be utilized.



Portable Display Module

### NAMUR COMPLIANCE

Model TA2 output signal meets NAMUR NE43 recommendations for the 4–20 mA signal levels.

### FACTORY CALIBRATION AND CONFIGURATION

Each TA2 is calibrated at the factory for the type of gas and the specified flow rate. The instrument is configured for the specific application information. The result is an instrument which can be installed and immediately be placed into operation without field setup.

### CALIBRATION VERIFICATION

MAGNETROL has developed a procedure to verify the calibration of the TA2 in the field. Following this procedure, the user can verify that the heat transfer characteristics of the instrument have not changed from first received. While the calibration is a permanent calibration, the user can now check the calibration without having to return the instrument to the manufacturer. When using a HART handheld or PACTware™, the user is guided through the procedure.

### ELECTRICAL WIRING

Elevated terminal strips with very visible markings make wiring of the TA2 extremely easy.

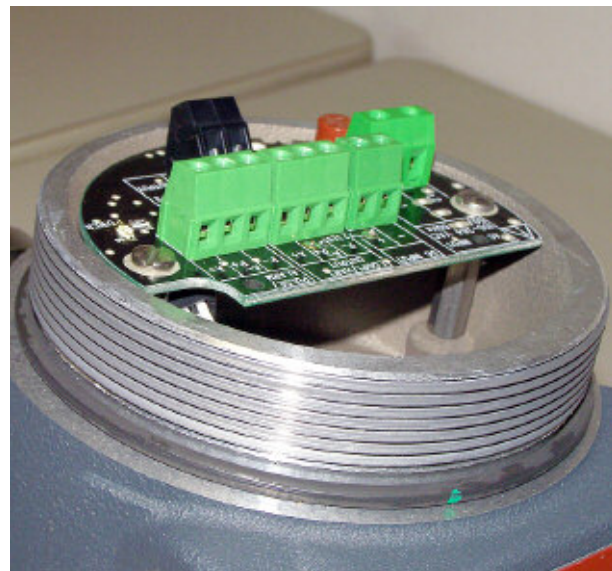



## The Most Efficient PC Configuration Tool for TA2 Mass Flow Meters

PACTware is the modern, user-friendly adjustment software that enables quick configuration and diagnostics of your TA2 mass flow meters.

With your PC connected through a serial interface to the HART loop, all functionality can be managed remotely anywhere on the loop.

**Parameters Screen** Every Parameter in the TA2 can be reviewed and monitored remotely with a few clicks of the mouse. From units of measurement to pipe size, I/O Configuration or Calibration Factors, the parameters can be viewed or changed.

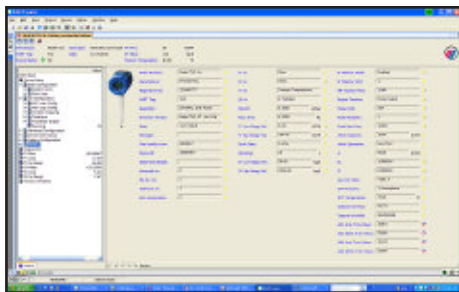

Parameters Screen

**Trending Screen** Trending is available of the flow rate, temperature, and signal providing useful information on the operation of the TA2. This is especially important for troubleshooting and diagnostics if required.

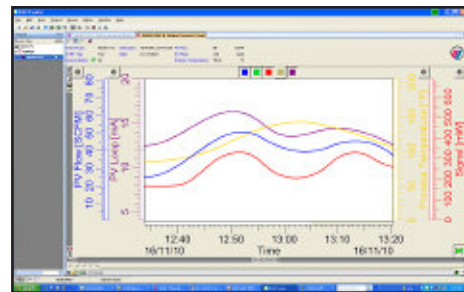

Process Trend Screen

## APPLICATIONS

### COMPRESSED AIR/GASES

Measurement of mass flow in different gas lines to determine compressor efficiency or in plant usage for internal allocation.

Advantages:

- direct mass flow
- flow totalization
- high turndown rates
- easy installation

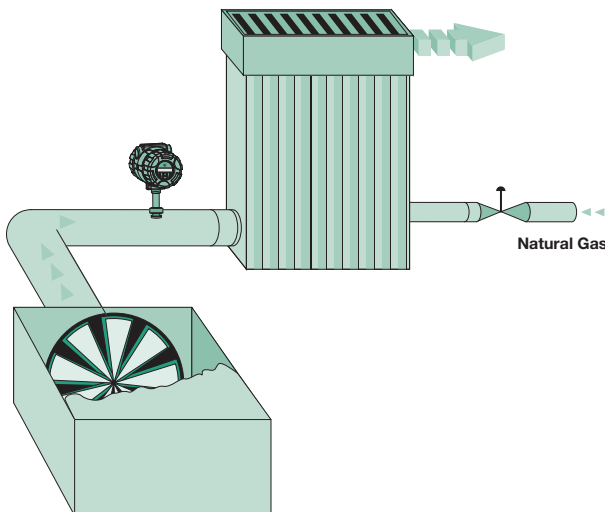
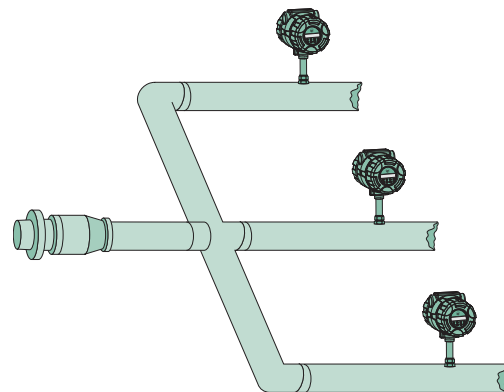

### BOILER COMBUSTION

The TA2 measures the inlet air flow to the boiler. This signal is sent to the DCS where it is used to trim the natural gas flow.

Advantages:

- mass flow measurement
- repeatable flow signal
- high rangeability

# APPLICATIONS

## NATURAL GAS FLOW

The Model TA2 efficiently measures the flow and totalized flow of fuel to furnaces, heaters, or boilers. This data may be used for internal allocation or to report emission rates.

Advantages:

- direct mass flow in SCFM
- built-in totalizer
- ease in setup and operation

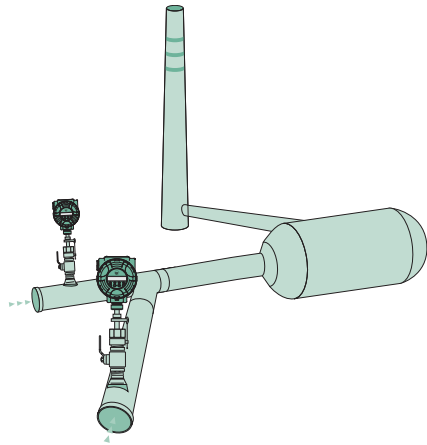
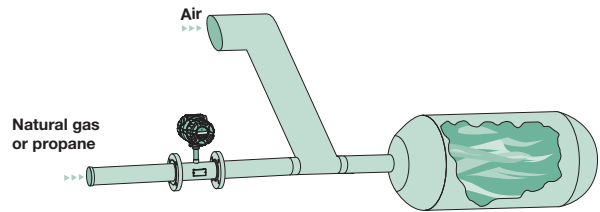

## FLARE LINES

Measurement of flow in different sections of flare line.

Advantages:

- good low flow sensitivity
- high turndown
- easy removal if cleaning is required

## AERATION AIR FLOW

Measurement and balance of the flow to each section of the aeration basin in waste water treatment plants.

Advantages:

- low installation cost
- direct mass flow
- high reliability

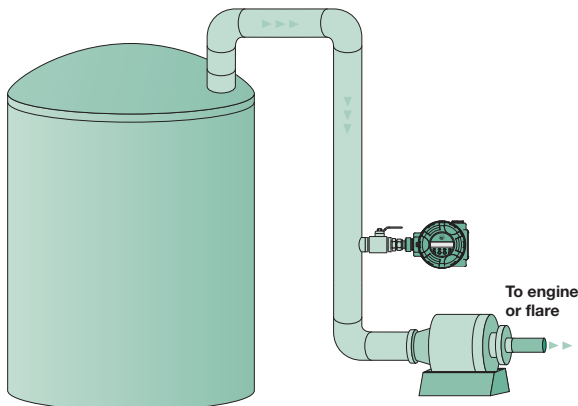
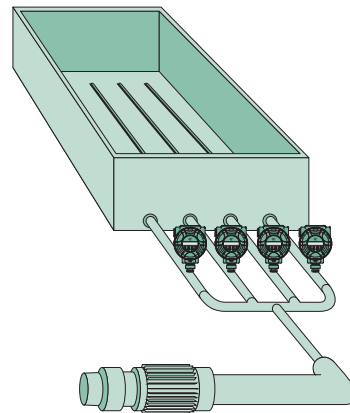

## DIGESTER GAS/BIO-GAS

The off gas from a digester contains a mixture of methane and carbon dioxide saturated with moisture. This is a difficult flow measurement due to low flow rate and low pressures.

Advantages:

- excellent low flow sensitivity
- high turndown rates
- provides measurement of flow and totalized flow

# TECHNOLOGY





THERMATEL Model TA2 flow transmitter measures mass flow by detecting heat dissipation from a heated surface. The sensor contains two mass balanced elements with precision matched RTDs. The reference sensor measures the process temperature (up to +400° F [+200° C]); the second RTD measures the temperature of the heated sensor. The power to the heater is varied to maintain a constant temperature difference above the reference temperature.

There is an inherent non-linear relationship between power and mass flow. The microprocessor in the TA2

compares the power against the calibration curve and converts the power requirements to the mass flow rate. Temperature is also measured to provide temperature compensation of the mass flow over the operating range of the instrument.

For further information on thermal mass flow measurement, request a copy of the MAGNETROL “Thermal Dispersion Mass Flow Measurement Handbook,” Bulletin 54-621.

# AGENCY APPROVALS

AGENCY	APPROVED MODEL	PROTECTION METHOD	AREA CLASSIFICATION
 <b>UNITED STATES</b> <b>FM</b> <b>APPROVED</b>	TA2-AXXX-X3X TA2-AXXX-X4X with TXR-XXXX-XXX (probe) TFT-XXXX-000 (flow body)	Explosion proof	Class I, Div 1, Groups B, C, & D Class II, Div 1, Groups E, F, & G Class III, T6 Ta = 160° F, T5 Ta = 175° F NEMA 4X, IP 66
		Non-Incendive	Class I, Div 2, Groups A, B, C, & D Class II, Div 2, Groups F & G Class III, T4 Ta = 160° F NEMA 4X, IP 66
 <b>CANADA</b> <b>FM</b> <b>APPROVED</b>	TA2-AXXX-X3X TA2-AXXX-X4X with TXR-XXXX-XXX (probe) TFT-XXXX-000 (flow body)	Explosion proof	Class I, Div 1, Groups B, C, & D Class II, Div 1, Groups E, F, & G Class III, T6 Ta = 160° F, T5 Ta = 175° F Type 4X
		Non Incendive:	Class I, Div 2, Groups A, B, C, & D Class II, Div 2, Groups E, F, & G Class III, T4 Ta = 160° F, T5 Ta = 175° F Type 4X
 <b>ATEX</b>	TA2-AXXX-X3X TA2-AXXX-X4X with TXR-XXX0-XXX (probe) TFT-XXXX-000 (flow body)	Explosion proof EN60079-0: 2007 EN60079-1: 2007	 II 2 G Ex d IIC T6, IP66
		Ex d Explosion proof w/IS probe circuit EN60079-0: 2007 EN60079-1: 2007 EN60079-11: 2007 EN60079-26: 2006	 II 1/2 G Ex d+ib d{ib} IIC T5/T4 IP66 Approval Pending
<b>ROS TECH/ GOST-R</b>	TA2-AXXX-X3X TA2-AXXX-X4X	Russian Authorization Standards - Consult MAGNETROL for Details	

Note: Maximum surface temperature of the probe is 4° C above process temperature.

 These units have been tested to EN 61326 and are in compliance with the EMC Directive 2004/106/EC.

# SPECIFICATIONS

## PERFORMANCE

Flow range maximum	10–50,000 SFPM (0.05–250 Nm/s) air reference to standard conditions Contact MAGNETROL for other gases
Accuracy flow	±1% of reading +0.5% of calibrated full scale
Accuracy temperature	±2° F (1° C)
Repeatability	±0.5% of reading
Linearity	Included in flow accuracy
Turn down	100:1 typical (depending on calibrated flow range)
Calibration	NIST traceable
Span	Minimum 0–100 SFPM
Response time	1 to 3 second time constant typical
Cable length	500 feet (150 m); (see page 11 for cable specifications)
SIL	Safe Failure Fraction (SFF) 88.4%

## TRANSMITTER

Display	Two-line alphanumeric LCD, 16 characters per line
Keypad	Four push button
Menu Language	English, French, German, Spanish, Russian
Supply voltage	100–264 VAC, 50–60 Hz ~ 11.6–30 VDC $\overline{=}$ (11.6 VDC requires integral electronics)
Power consumption	DC = 6.8 watts, AC = 7 VA typical, 11.9 VA maximum
Signal Output	4–20 mA, HART available (3.8 to 20.5 mA useable—meets NAMUR NE 43)
Analog output signal	Active 4–20 mA (isolated) maximum 1000 $\Omega$ loop resistance Passive 4–20 mA (isolated) loop resistance dependent on power supply, 11–36 VDC
Diagnostic Alarm	3.6 mA, 22 mA, HOLD
HART	Optional
Pulse Output	Active Connection—24 VDC ( $\pm 10\%$ ) Power, 150 mA Passive Connection—2.5 to 60 VDC Power, 1.5 AMP
Alarm Output	Active Connection—24 VDC ( $\pm 10\%$ ) Power, 100 mA Passive Connection—2.5 to 60 VDC Power, 1 AMP
Ambient temperature	-40° to +176° F (-40° to +80° C); display not readable below -22° F (-30° C)
Temperature effect	Approximately $\pm 0.04\%$ of reading per ° C
Humidity	99% Non-condensing
Housing Material	Aluminum A356 (<0.2% copper)
Shock Vibration	ANSI/ISA-S71.03 table 2, level SA1 (Shock), ANSI/ISA-S71.03 table 1, level VC2 (Vibration)

## PROBE

Materials	316/316L stainless steel all welded Hastelloy® C-276
Process connections	Refer to model number, hot tap optional
Process Pressure	1500 psig @ +70° F (103 bar @ +20° C), 1375 psig @ +400° F (95 bar @ +200° C)
Temperature rating	-50° to +400° F (-45° to +200° C) ①

## FLOW BODY

Materials	316/316L stainless steel all welded Carbon steel with stainless steel sensor
Process connections	NPT or 150-pound flange – Refer to model number
Pressure rating	1500 psig @ +70° F (103 bar @ +20° C), 1100 psig @ +400° F (76 bar @ +200° C)
Temperature rating	-50° to +400° F (-45° to +200° C) ①

① For operating temperatures between +250° and +400° F (+120° and +200° C), either use remote electronics or a longer length insertion probe to provide an additional four inches (100 mm) between the electronics and the compression fitting.

# MODEL NUMBER

**Models available for quick shipment, usually within one week after factory receipt of a complete purchase order, through the Expedite Ship Plan (ESP)**

## SIGNAL OUTPUT

0	4-20 mA
1	4-20 mA with HART
4	4-20 mA with HART, Pulse/Alarm, second mA Output

## DISPLAY

0	None
B	Plug-in display with keypad (with window)

## CALIBRATION—INSERTION PROBE

Actual Gas Calibration	
0	Special
1	Air
2	Nitrogen
3	Hydrogen
4	Natural Gas
5	Methane
6	Digester Gas
7	Propane
8	Oxygen
Air Equivalency Calibration	
9	Air Equivalency

## CALIBRATION – FLOW BODY

Actual Gas Calibration	
A	Special
B	Air
C	Nitrogen
D	Hydrogen
E	Natural Gas
F	Methane
G	Digester Gas
H	Propane
J	Oxygen
Air Equivalency Calibration	
K	Air Equivalency

## HOUSING LOCATION / AGENCY APPROVAL

3	Integral, general purpose, non-incendive, & explosion proof FM/FMC (class B, C, & D), ATEX Exd
4	Remote, general purpose, non-incendive, & explosion proof FM/FMC (class B, C, & D), ATEX Exd
E	Integral, general purpose, ATEX, Ex d + ib
F	Remote, general purpose, ATEX, Ex d + ib

## ENCLOSURE TYPE

0	Aluminum, 3/4" NPT
1	Aluminum, M20





# MODEL NUMBER

## INSERTION PROBE

### THERMATEL PROBE

T E	Probe length in inches
T M	Probe length in centimeters

### PROBE TYPE

R	3/4" diameter probe
---	---------------------

### MATERIALS OF CONSTRUCTION

A	316/316L Stainless Steel
B	Hastelloy C

### PROCESS CONNECTION SIZE

00	Compression Fitting Utilized (customer supplied)
03	3/4" NPT SS compression fitting with Teflon Ferrules
04	3/4" NPT SS compression fitting with Stainless Steel Ferrules
05	1" NPT SS compression fitting with Teflon Ferrules
06	1" NPT SS compression fitting with Stainless Steel Ferrules
11	3/4" NPT
21	1" NPT
22	G1 (1" BSP)

### ANSI FLANGES

23	1" 150# ANSI raised face flange
24	1" 300# ANSI raised face flange
33	1 1/2" 150# ANSI raised face flange
34	1 1/2" 300# ANSI raised face flange
43	2" 150# ANSI raised face flange
44	2" 300# ANSI raised face flange

### DIN FLANGES

BB	DN 25 PN 16/25/40 EN 1092-1, Type A
CB	DN 40 PN 16/25/40 EN 1092-1, Type A
DA	DN 50 PN 16 EN 1092-1, Type A
DB	DN 50 PN 25/40 EN 1092-1, Type A

### PROBE LENGTH

2.6 to 99.9 inches (example 8.5" = 085) Minimum lengths: 2.6" (026) with threaded process connection 2.8" (028) with flanged process connection 4.5" (045) with compression fitting process connection
7 to 253 centimeters (example: 18 cm = 018) Minimum lengths: 7 cm (007) with threaded or flanged process connection 11 cm (011) with compression fitting process connection

The following probes are available through the Expedite Ship Plan:

TER-A0XA-080	TMR-A0XA-020
TER-A0XA-180	TMR-A0XA-046



# MODEL NUMBER

## FLOW BODY

### MATERIALS OF CONSTRUCTION

A	All stainless steel
1	Carbon steel body with stainless steel sensor

### SIZE

0	½ inch
1	¾ inch
2	1 inch
3	1½ inch
4	2 inch
5	3 inch
6	4 inch

### PROCESS CONNECTION TYPE

1	NPT Threads (only when Digit 5 = 0, 1, 2, 3, or 4)
3	150# Flange

### FLOW CONDITIONING PLATE (stainless steel)

A	Not provided
B	Provided (only when Digit 5 = 3, 4, 5, or 6)

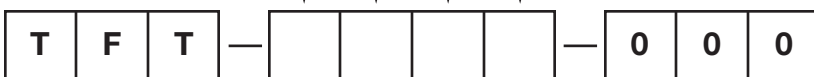

# CONNECTING CABLE

---

## FOR CABLE LENGTHS UP TO 200 FEET

037-3313-XXX (Cable length in feet)—10 feet minimum, 200 feet maximum length

Example: 50 feet = 050

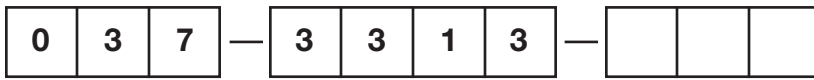

## FOR CABLE LENGTHS UP TO 60 METERS

037-3314-XXX (Cable length in meters)—3 meters minimum, 60 meters maximum length

Example: 8 meters = 008

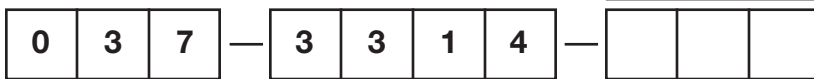

---

## FOR CABLE LENGTHS BETWEEN 200 AND 500 FEET

037-3319-XXX (Cable length in feet)—10 feet minimum, 500 feet maximum length

Example: 300 feet = 300

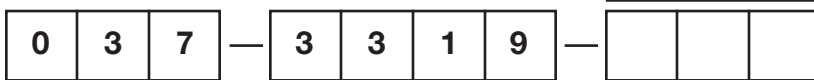

## FOR CABLE LENGTHS BETWEEN 60 AND 150 METERS

037-3320-XXX (Cable length in meters)—3 meters minimum, 150 meters maximum length

Example: 80 meters = 080

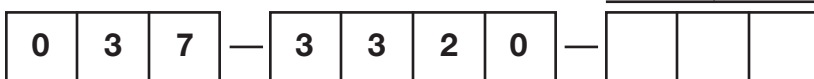

# RETRACTABLE PROBE ASSEMBLY

## HOT TAP

Two methods are offered of removing the probe from the pipe without having to shut down the process. The Hot Tap Retractable Probe Assembly (RPA) is designed to meet API (American Petroleum Institute) standards. The less demanding valve and compression fitting (part number 089-5218-001) will have some minor leakage when the probe is removed or re-inserted and does not have the safety cable to prevent “blow out” of the probe when removed under pressure.

RPA requires a probe with 3/4" NPT process connection (code 11).

The valve with compression fitting uses a 1" NPT connection while the RPA uses a 1/2" NPT connection.

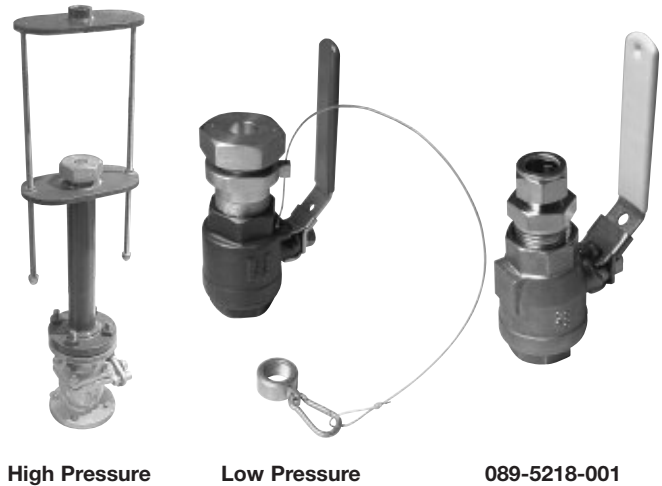

### BASIC MODEL NUMBER

RPA	Retractable probe assembly
-----	----------------------------

#### DESIGN TYPE

5	Low pressure (up to 80 psi, 5.5 bar), length in tenths of an inch
6	High pressure (up to 300# class service), length in tenths of an inch
E	Low pressure (up to 80 psi, 5.5 bar), length in centimeters
F	High pressure (up to 300# class service), length in centimeters

#### MATERIALS OF CONSTRUCTION

1	Carbon steel (available on flange and high pressure units). Seal gland is 316 stainless steel.
4	316 stainless steel

#### PROCESS CONNECTION

0	1/2" NPT
1	1/2" 150# flange
2	1/2" 300# flange

#### BALL VALVE

0	None
1	Carbon steel
2	Stainless steel

#### PROBE LENGTH

10 to 99.9 inches (example: 12" = 120)
25 to 253 centimeters (example: 30 cm = 030)

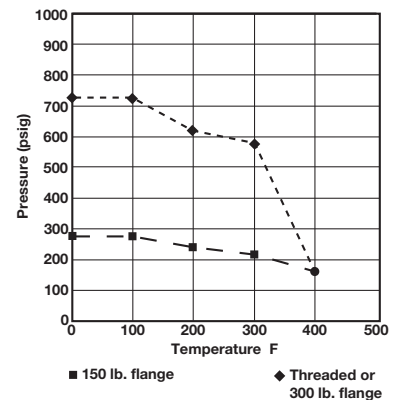

# DIMENSIONAL SPECIFICATIONS

## HOT TAP – inches (mm)

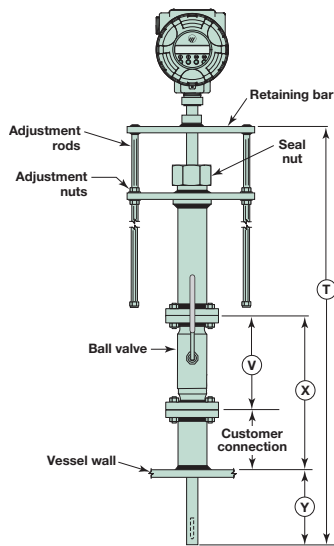

**Hot Tap  
Model RPA-6X12-XXX**  
Minimum Probe Length:  
 $T = 2(X+Y)$

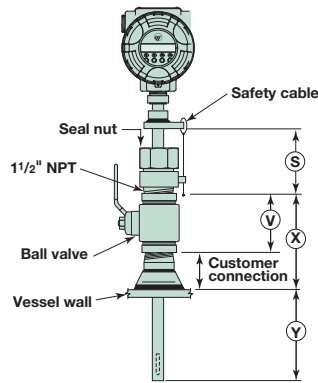

**Hot Tap  
Model RPA-5402-XXX**  
Minimum Probe Length  
 $= S+X+Y$

S Dimension	
Threaded conn.	4.0 (102)
Flanged conn.	5.0 (127)

Ball Valve Dimensions*	
Size	V
1 1/2" NPT	4.4 (112)
1 1/2" 150# flange	6.5 (165)
1 1/2" 300# flange	7.5 (191)

\*Dimension of ball valve if supplied by MAGNETROL.

**Dimension V:**  
Ball valve dimension  
(see chart)

**Dimension X:**  
Length from wall to  
top of ball valve

**Dimension Y:**  
Insertion length into pipe

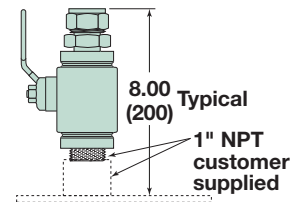

**Valve with  
Compression Fitting (089-  
5218-001)**

## INTEGRAL MOUNT – inches (mm)

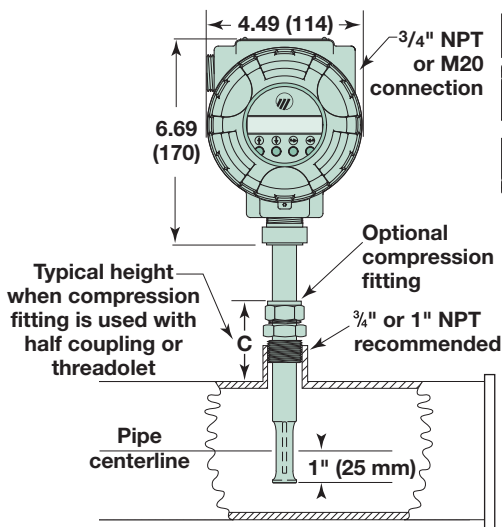

**Integral Mount Model TA2  
Front and Side Views**

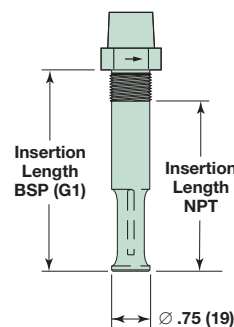
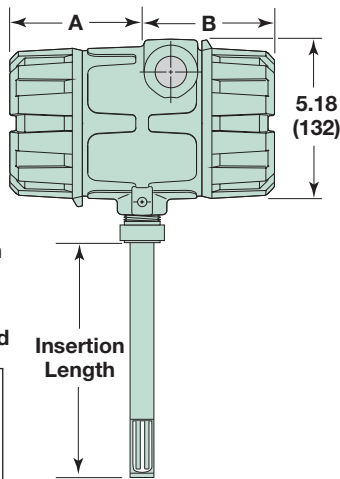

**TXR with  
Threaded Connection**

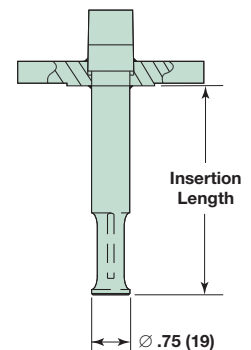

**TXR with  
Flanged Connection**

Process Conn. Size	Height C	Compression fitting	
		Teflon ferrules	Stainless steel ferrules
1" NPT	3.1 (79)	011-4719-009 (100 psi maximum)	011-4719-007 (1500 psi maximum)
3/4" NPT	2.6 (66)	011-4719-008 (100 psi maximum)	011-4719-006 (1500 psi maximum)

**Dimension A:**  
3.33 (85) without display  
3.88 (99) with display

**Dimension B:**  
3.88 (98)

# DIMENSIONAL SPECIFICATIONS

## REMOTE MOUNT – inches (mm)

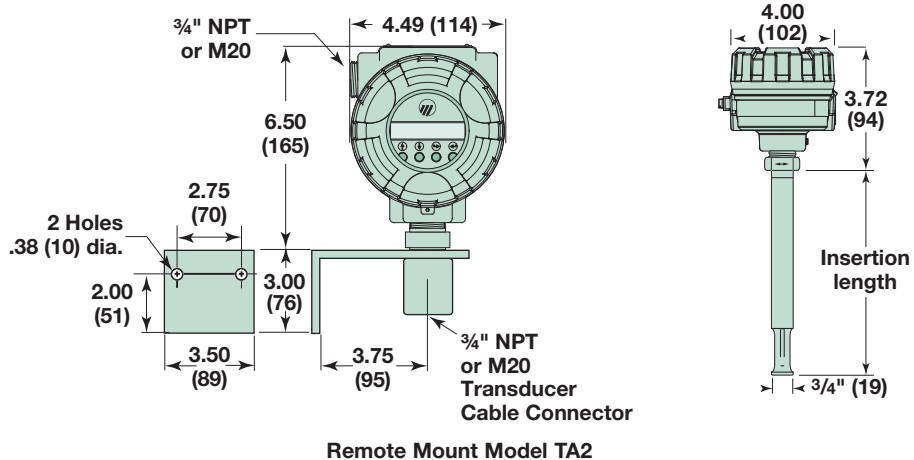

## FLOW BODY – see chart at right

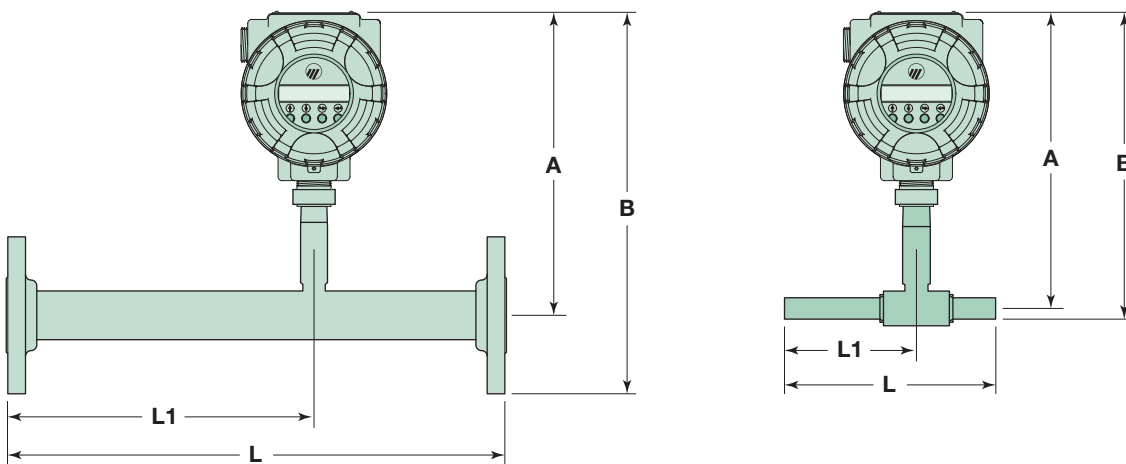

**Pressure Drop**

**Pressure Drop with Flow Conditioning Plate**

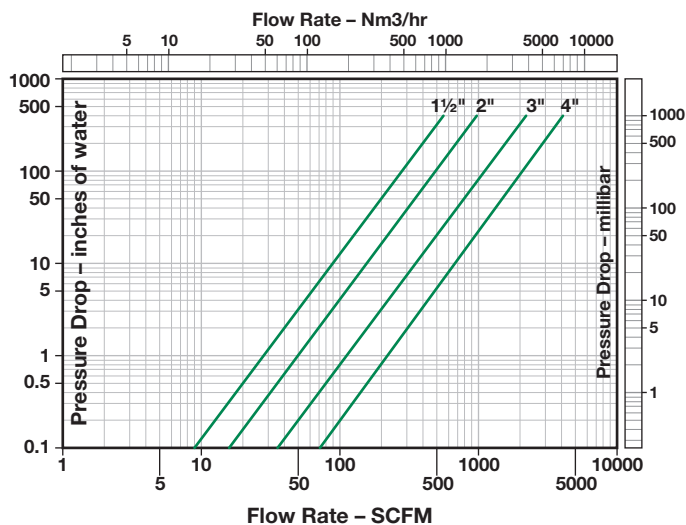
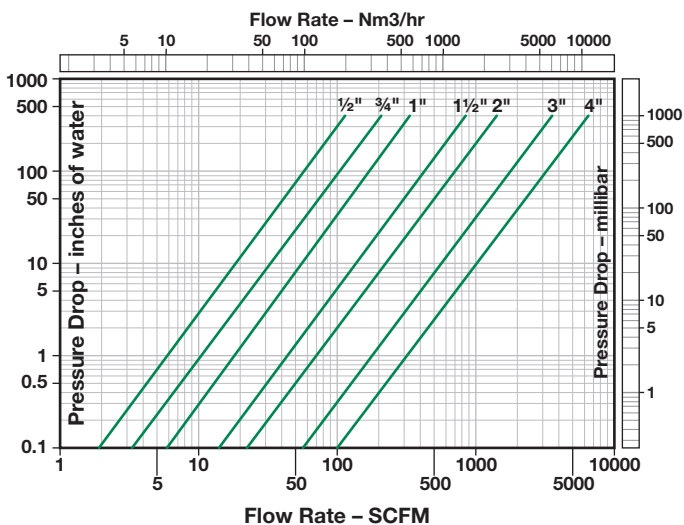

Pressure drop is based on air at +70° F and 1 atmosphere (density = 0.075 lb/ft<sup>3</sup>). For other gases, pressure or temperatures, estimate pressure drop by multiplying value from chart by actual density (at operating conditions) divided by 0.075.

# FLOW BODY SIZING

The following table is a general guide on flow sizing. Contact factory or your local representative for specific application information.

Code	Size	Air, N <sub>2</sub> , O <sub>2</sub>	Natural Gas, Methane	Digester Gas	Propane	Hydrogen	CO <sub>2</sub> , Argon
0	½"	85 SCFM 145 Nm <sup>3</sup> /h	60 SCFM 100 Nm <sup>3</sup> /h	60 SCFM 100 Nm <sup>3</sup> /h	30 SCFM 50 Nm <sup>3</sup> /h	20 SCFM 35 Nm <sup>3</sup> /h	80 SCFM 140 Nm <sup>3</sup> /h
1	¾"	162 SCFM 275 Nm <sup>3</sup> /h	115 SCFM 195 Nm <sup>3</sup> /h	115 SCFM 195 Nm <sup>3</sup> /h	55 SCFM 95 Nm <sup>3</sup> /h	40 SCFM 70 Nm <sup>3</sup> /h	150 SCFM 250 Nm <sup>3</sup> /h
2	1"	270 SCFM 459 Nm <sup>3</sup> /h	190 SCFM 320 Nm <sup>3</sup> /h	190 SCFM 320 Nm <sup>3</sup> /h	95 SCFM 160 Nm <sup>3</sup> /h	65 SCFM 115 Nm <sup>3</sup> /h	250 SCFM 435 Nm <sup>3</sup> /h
3	1½"	660 SCFM 1120 Nm <sup>3</sup> /h	460 SCFM 780 Nm <sup>3</sup> /h	460 SCFM 780 Nm <sup>3</sup> /h	230 SCFM 390 Nm <sup>3</sup> /h	160 SCFM 275 Nm <sup>3</sup> /h	625 SCFM 1060 Nm <sup>3</sup> /h
4	2"	965 SCFM 1640 Nm <sup>3</sup> /h	680 SCFM 1160 Nm <sup>3</sup> /h	680 SCFM 1160 Nm <sup>3</sup> /h	350 SCFM 600 Nm <sup>3</sup> /h	265 SCFM 450 Nm <sup>3</sup> /h	920 SCFM 1560 Nm <sup>3</sup> /h
5	3"	2700 SCFM 4580 Nm <sup>3</sup> /h	1890 SCFM 3210 Nm <sup>3</sup> /h	1890 SCFM 3210 Nm <sup>3</sup> /h	690 SCFM 1170 Nm <sup>3</sup> /h	730 SCFM 1230 Nm <sup>3</sup> /h	2560 SCFM 4360 Nm <sup>3</sup> /h
6	4"	4860 SCFM 8260 Nm <sup>3</sup> /h	3400 SCFM 5780 Nm <sup>3</sup> /h	3400 SCFM 5780 Nm <sup>3</sup> /h	1230 SCFM 2090 Nm <sup>3</sup> /h	1310 SCFM 2200 Nm <sup>3</sup> /h	4620 SCFM 7845 Nm <sup>3</sup> /h

# FLOW BODY DIMENSIONS CHART

inches (mm)

Code	Size	Length (L)		L1		Height to Centerline (A)	Overall Height (B)	
		With Flow Conditioning	Without Flow Conditioning	With Flow Conditioning	Without Flow Conditioning		NPT	Flange
0	½"	8 (203)	—	5 (127)	—	8.0 (203)	8.4 (213)	9.7 (246)
1	¾"	11.25 (285)	—	7.5 (190)	—	8.0 (203)	8.5 (216)	9.9 (251)
2	1"	15 (381)	—	10 (254)	—	8.0 (203)	8.6 (218)	10.1 (257)
3	1½"	19.5 (495)	7.5 (191)	12 (305)	3.75 (95)	8.3 (210)	9.2 (234)	10.8 (274)
4	2"	26 (660)	7.5 (191)	16 (406)	3.75 (95)	9.5 (241)	10.7 (272)	12.5 (318)
5	3"	39 (991)	10 (254)	24 (610)	5 (127)	9.5 (241)	N/A	13.3 (338)
6	4"	52 (1321)	12 (305)	36 (914)	6 (152)	9.5 (241)	N/A	14.0 (356)

Flow conditioning on ½" to 1" is provided due to length of flow body and sensor design.

Optional flow conditioning plate is available on flow bodies 1½" and larger.

## QUALITY

---



The quality assurance system in place at MAGNETROL guarantees the highest level of quality throughout the company. MAGNETROL is committed to providing full customer satisfaction both in quality products and quality service.

The MAGNETROL quality assurance system is registered to ISO 9001 affirming its commitment to known international quality standards providing the strongest assurance of product/service quality available.

## ESP

---

### Expedite Ship Plan

Several TA2 Models are available for quick shipment, usually within one week after factory receipt of a purchase order, through the Expedite Ship Plan (ESP).

ESP service may not apply to orders of ten units or more. Contact your local representative for lead times on larger volume orders, as well as other products and options.

## WARRANTY

---



All MAGNETROL electronic level and flow controls are warranted free of defects in materials or workmanship for one full year from the date of original factory shipment.

If returned within the warranty period; and, upon factory inspection of the control, the cause of the claim is determined to be covered under the warranty; then, MAGNETROL will repair or replace the control at no cost

to the purchaser (or owner) other than transportation.

MAGNETROL shall not be liable for misapplication, labor claims, direct or consequential damage or expense arising from the installation or use of equipment. There are no other warranties expressed or implied, except special written warranties covering some MAGNETROL products.

### Additional information

The following additional THERMATEL literature is available from your local representative:

- 54-631 THERMATEL Model TA2 Mass Flow Transmitter Instruction Manual and Parts List
- 54-100 THERMATEL Technology brochure
- 54-105 THERMATEL TG1 Flow and Level Switch sales literature
- 54-110 THERMATEL Model TD1/TD2 Thermal Dispersion Flow and Level Switch sales literature
- 54-131 THERMATEL Model TA2 Probe location literature
- 54-210 Thermal Dispersion Mass Flow Meter Applications
- 54-621 Thermal Dispersion Mass Flow Measurement Handbook



5300 Belmont Road • Downers Grove, Illinois 60515-4499 • 630-969-4000 • Fax 630-969-9489 • [www.magnetrol.com](http://www.magnetrol.com)  
145 Jardin Drive, Units 1 & 2 • Concord, Ontario Canada L4K 1X7 • 905-738-9600 • Fax 905-738-1306  
Heikensstraat 6 • B 9240 Zele, Belgium • 052 45.11.11 • Fax 052 45.09.93  
Regent Business Ctr., Jubilee Rd. • Burgess Hill, Sussex RH15 9TL U.K. • 01444-871313 • Fax 01444-871317

Copyright © 2011 MAGNETROL INTERNATIONAL, INCORPORATED. All rights reserved. Printed in the USA.  
Performance specifications are effective with date of issue and are subject to change without notice.

MAGNETROL, MAGNETROL logotype and THERMATEL are registered trademarks of MAGNETROL INTERNATIONAL, INCORPORATED.  
CSA logotype is a registered trademark of Canadian Standards Association  
HART is a registered trademark of the HART Communication Foundation  
Hastelloy is a registered trademark of Haynes International, Inc.

**BULLETIN: 54-140.0**  
**EFFECTIVE: January 2011**