

# Hyperabrupt Varactor-Tuned Oscillators

## Technical Data

### Features

- **25 MHz to 2.3 GHz Coverage**
- **Fast Tuning**
- **Fast Setting Time**
- **+20 VDC Max Tuning Voltage**
- **10 mW Output Power**
- **± 2.0 dB Output Flatness**
- **Hermetic Thin-film Construction**

### Description

HP VTO-9000 Hyperabrupt Series oscillators use a silicon transistor chip as a negative resistance oscillator. The oscillation frequency is determined by a silicon hyperabrupt varactor diode acting as a voltage-variable capacitor in a thin-film microstripline resonator.

This provides extremely fast tuning speed limited primarily by the internal impedance of the user-supplied voltage driver.

This family of oscillators is similar to the standard commercial VTO-8000 Series except for the incorporation of a silicon hyperabrupt varactor tuning diode. This enables the oscillator to be tuned over the specified range in less than 20 volts rather than 40 to 50 volts in conventional oscillators.

The VTO-9000 Series VTOs are packaged in TO-8 transistor cans for simple installation in a conventional 50-ohm microstripline PC board. They are ideal for most compact

## VTO-9000 Series

### Pin Configuration TO-8V

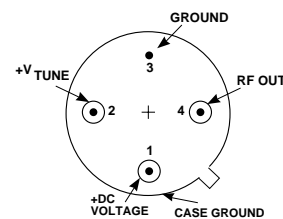

lightweight commercial and military equipment designs. Test fixturing is also available for lab bench test applications. See the "Test Fixtures for TO-8 Packages" section for additional information and outlines.

### Applications

The VTO-9000 Series oscillators may be used in the same applications as VTO-8000 Series oscillators. The VTO-9000 Series is the desired choice for superior linearity and modulation sensitivity requirements.

### Schematic

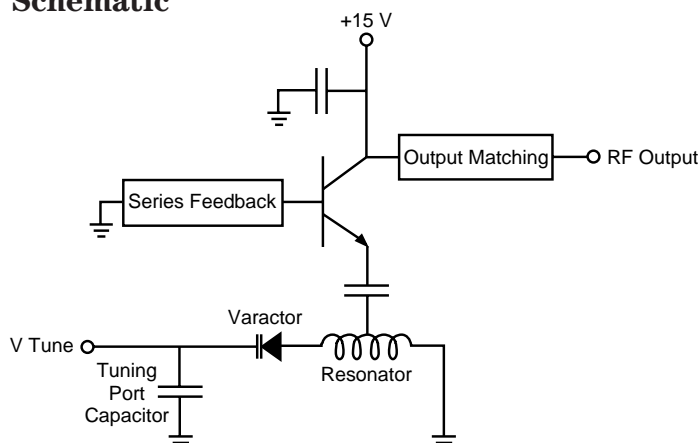

## Electrical and Performance Specifications

Guaranteed Specifications @ 25°C Case Temperature (0° to +65°C Operating Temperature)

Model No.	VTO-9032	VTO-9050	VTO-9068	VTO-9090
Frequency Range, Min.	320–640 MHz	500–1000 MHz	680–1360 MHz,	900–1600 MHz
Power Output Into 50–ohm Load, Min.	10 mW/+10 dBm	10 mW/+10 dBm	10 mW/+10 dBm	10 mW/+10 dBm
Power Output Variation @ 25°C, Max.	± 2 dB	± 2 dB	± 2 dB	± 2 dB
Operating Carrier Temperature Range	0° to +65°C	0° to +65°C	0° to +65°C	0° to +65°C
Frequency Drift Over Operating Temperature, Typ.	12 MHz	20 MHz	20 MHz	20 MHz
Pulling Figure (12 dB Return Loss), Typ.	20 MHz	20 MHz	25 MHz	25 MHz
Pushing Figure, +15 VDC Supply, Typ.	5 MHz/V	5 MHz/V	6 MHz/V	6 MHz/V
Harmonics, Below Carrier, Typ.	-14 dB	-10 dB	-14 dB	-14 dB
Spurious Output Below Carrier, Min.	-60 dB	-60 dB	-60 dB	-60 dB
Tuning Voltage				
Low Frequency, Min.	0 VDC	0 VDC	0 VDC	2 VDC
High Frequency, Max	20 VDC	20 VDC	20 VDC	18 VDC
Maximum Tuning Voltage	+20 VDC	+20 VDC	+20 VDC	+20 VDC
Tuning Port Capacitance, Nom.	200 pF	200 pF	190 pF	190 pF
Phase Noise, Single Sideband,				
1 Hz Bandwidth, Typ.				
50 kHz From Carrier	-95 dBc/Hz	-100 dBc/Hz	-95 dBc/Hz	-100 dBc/Hz
100 kHz From Carrier	-103 dBc/Hz	-108 dBc/Hz	-103 dBc/Hz	-108 dBc/Hz
Input Power, ± 1% Regulation				
Voltage, Nom.	+15 VDC	+15 VDC	+15 VDC	+15 VDC
Current, Max.	50 mA	50 mA	50 mA	50 mA
Case Style	TO-8V	TO-8V	TO-8V	TO-8V

## Electrical and Performance Specifications

Guaranteed Specifications @ 25°C Case Temperature (0° to +65°C Operating Temperature)

Model No.	VTO-9120	VTO-9130
Frequency Range, Min.	1200–2000 MHz	1300–2300 MHz
Power Output Into 50–ohm load, Min.	10 mW/+10 dBm	10 mW/+10 dBm
Power Output Variation @ 25°C, Max.	± 2 dB	± 1.5 dB
Operating Case Temperature Range	0° to +65°C	0° to +65°C
Frequency Drift Over Operating Temperature, Typ.	25 MHz	25 MHz
Pulling Figure (12 dB Return Loss), Typ.	25 MHz	50 MHz
Pushing Figure, +15 VDC Supply, Typ.	10 MHz/V	10 MHz/V
Harmonics, Below Carrier, Typ.	-14 dB	-15 dB
Spurious Output Below Carrier, Min.	-60 dB	-60 dB
Tuning Voltage		
Low Frequency	3± 1 VDC	2 VDC Min.
High Frequency	12± 2 VDC	20 VDC Max.
Maximum Tuning Voltage	+20 VDC	+ 20 VDC
Tuning Port Capacitance, Nom.	100 pF	100 pF
Phase Noise, Single Sideband,		
1 Hz, Bandwidth, Typ.		
50 kHz From Carrier	-97 dBc/Hz	-97 dBc/Hz
100 kHz From Carrier	-105 dBc/Hz	-105 dBc/Hz
Input Power, ± 1% Regulation		
Voltage, Nom.	+15 VDC	+15 VDC
Current, Max.	50 mA	50 mA
Case Style	TO-8V	TO-8V

## Typical Performance @ 25°C Case Temperature

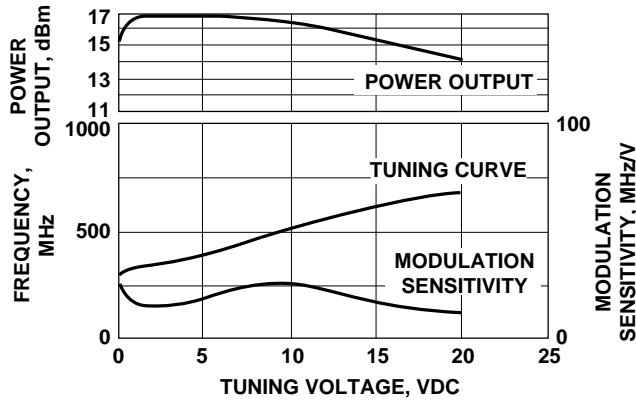

Figure 1. VTO-9032 Power Output, Frequency and Modulation Sensitivity vs. Tuning Voltage

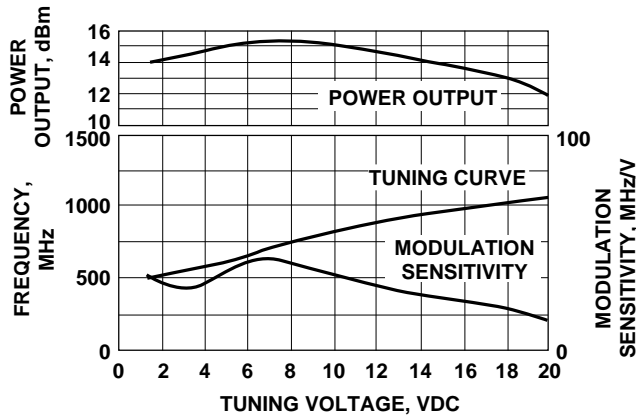

Figure 3. VTO-9050 Power Output, Frequency and Modulation Sensitivity vs. Tuning Voltage.

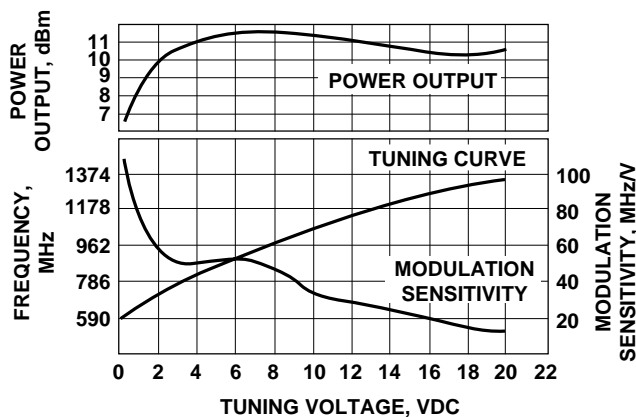

Figure 5. VTO-9068 Power Output, Frequency and Modulation Sensitivity vs. Tuning Voltage.

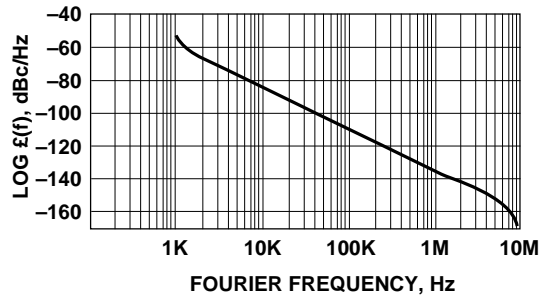

Figure 2. VTO-9032 Normalized Phase Noise @ 640 MHz S.S.B. Power Spectral Density.

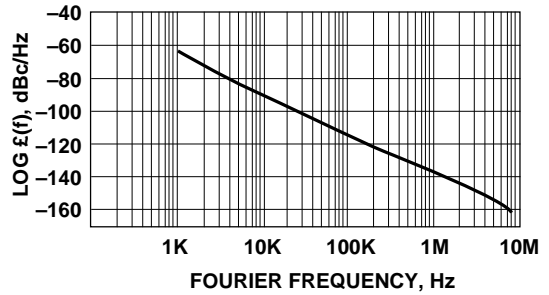

Figure 4. VTO-9050 Normalized Phase Noise @ 1000 MHz S.S.B. Power Spectral Density.

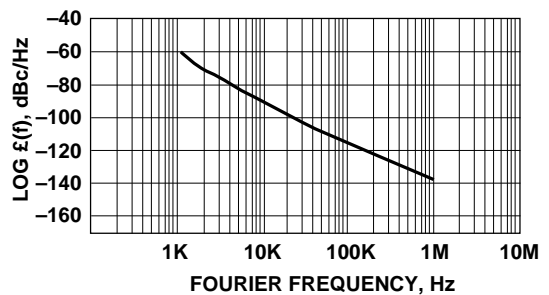

Figure 6. VTO-9068 Normalized Phase Noise @ 1360 MHz S.S.B. Power Spectral Density.

Typical Performance @ 25°C Case Temperature (continued)

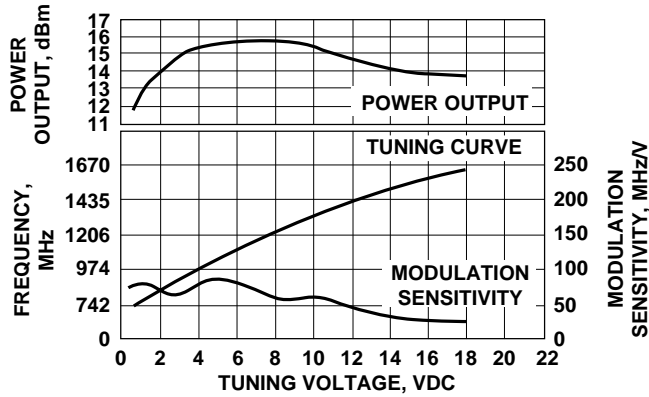

Figure 7. VTO-9090 Power Output, Frequency and Modulation Sensitivity vs. Tuning Voltage.

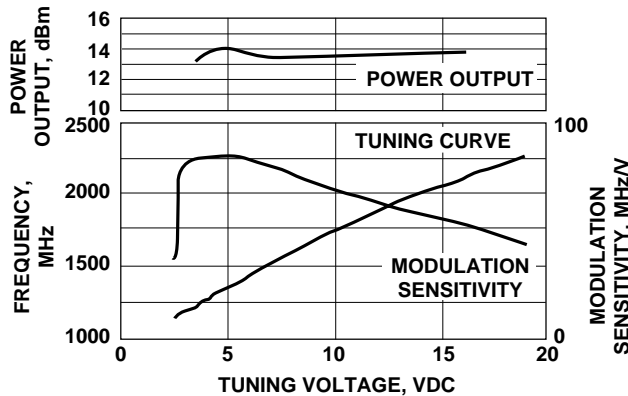

Figure 9. VTO-9120 Power Output, Frequency and Modulation Sensitivity vs. Tuning Voltage.

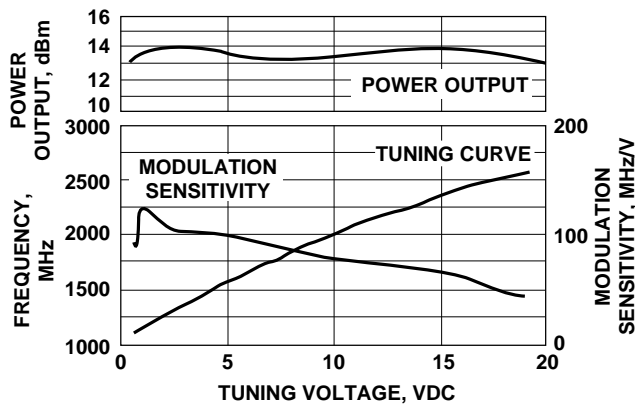

Figure 11. VTO-9130 Power Output, Frequency and Modulation Sensitivity vs. Tuning Voltage.

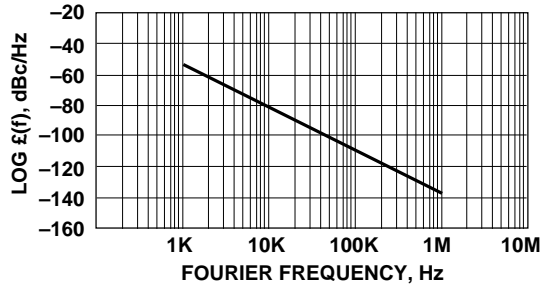

Figure 8. VTO-9090 Noise @ 1000 MHz Single Sideband Phase Noise.

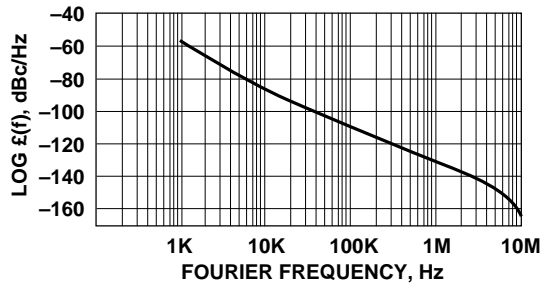

Figure 10. VTO-9120 Normalized Phase Noise @ 2000 MHz S.S.B. Power Spectral Density.

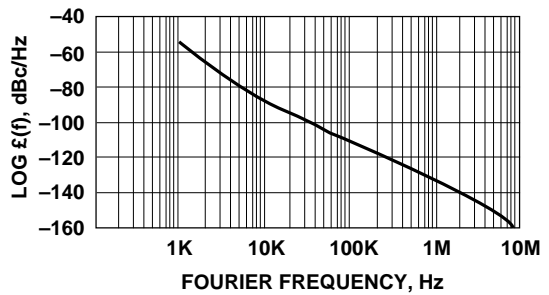
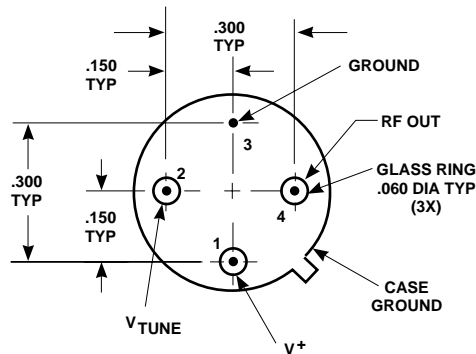
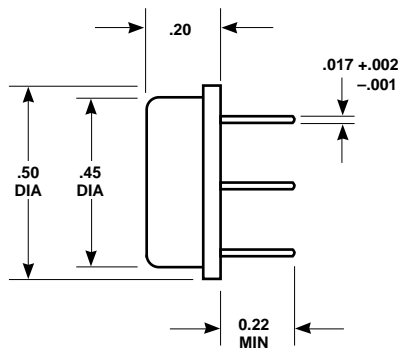

Figure 12. VTO-9130 Normalized Phase Noise @ 2300 MHz S.S.B. Power Spectral Density.

## TO-8V Case Drawing



APPROXIMATE WEIGHT 1.7 GRAMS

NOTES (UNLESS OTHERWISE SPECIFIED):  
 1. DIMENSIONS ARE SPECIFIED IN INCHES  
 2. TOLERANCES: xx ± .02  
 xxx ± .010

## Test Fixtures for TO-8 Packages (TF 801/802) Oscillators (VTO)

### Features

- DC to 11 GHz Frequency Range
- Connectorized Tuning Port and RF Output
- Easy to Test Package
- Repeatable Performance

### Applications

- Engineering Characterization
- Incoming Inspection
- System Prototype
- Demonstration of Device Performance

## Description

To facilitate testing and prototyping of products in the TO-8V package, a series of test fixtures is available. Designated the HP TF Series test fixtures, they feature rugged construction for precise, repeatable measurements.

The TF Series test fixtures come supplied with mounting hardware to ensure excellent ground contact between the oscillator package and test fixture. This assures excellent contact between package pins and test fixture connector pins for reliable testing.

The device under test is aligned according to Figure 13, and pushed fully down onto the fixture. The steel mounting ring

clamp is placed over the device under test and secured by machine screws prior to testing. Orientation of pins can be verified by comparison with part (c) of Figure 13. It is recommended that both machine screws be used to fasten the ring clamp. Screws should be tightened down snugly with a jewelers type screwdriver.

For different connector options check the table in Figure 13 to identify the correct part numbers.

It should be noted that some output power variation may be seen, from unit data, at frequencies above 8 GHz. This is due to small differences in lengths of test fixture RF output connector pins.

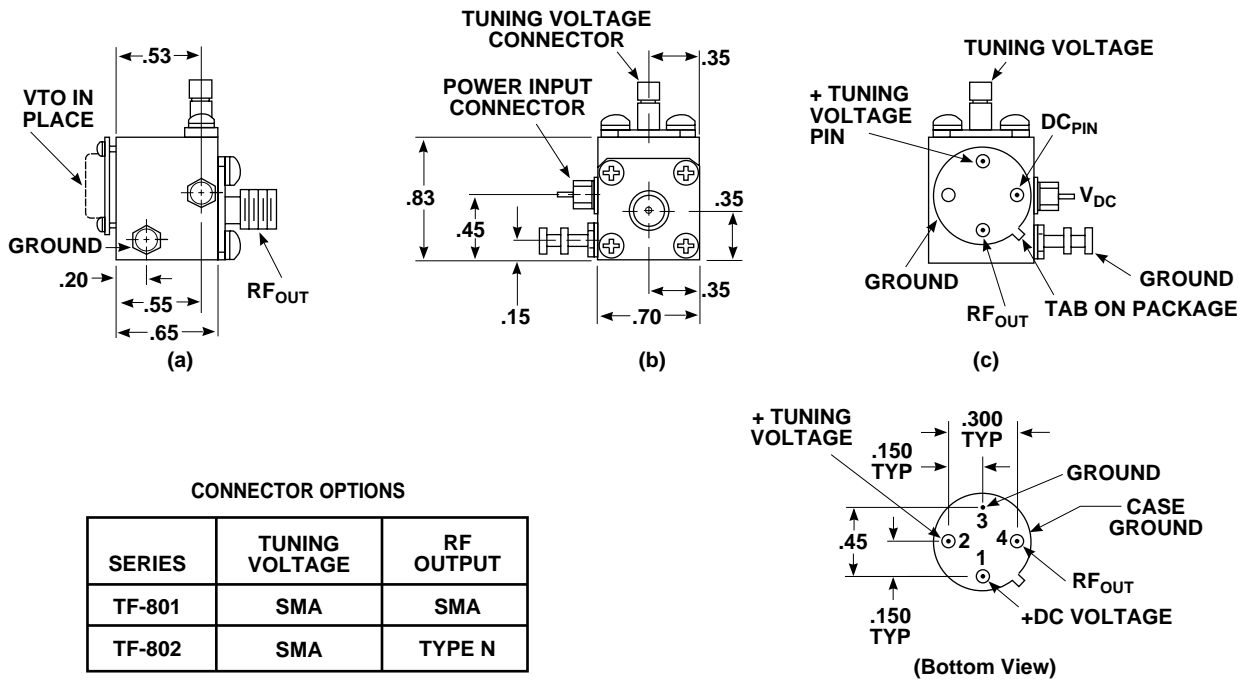

Figure 13. TO-8 Test Fixture.