

Evaluation Board 2s SKYPER™ 32

Technical Explanations

Revision 02

Status: **evaluation board**

This Technical Explanation is valid for the following parts:

<i>part number</i>	<i>type</i>	<i>date code (YYWW)</i>
L6100140	Board 2s SKYPER™ 32	≥ 0522

Related documents:

<i>title</i>	<i>version</i>
Technical Explanations SKYPER™ 32	≥ Rev04

Prepared by: Markus Hermwille

Content

Disclaimer.....	2
Application and Handling Instructions.....	3
Further application support.....	3
General Description.....	3
Dimensions.....	4
Component Placement Layout.....	4
PIN Array.....	5
Setting Dynamic Short Circuit Protection.....	6
Collector Series Resistance.....	6
Adaptation Gate Resistors.....	6
Boost Capacitors.....	7
Temperature Signal.....	7
Mounting Notes.....	7
Schematics.....	8
Layouts.....	9
Parts List.....	9

Information furnished in this document is believed to be accurate and reliable. However, no representation or warranty is given and no liability is assumed with respect to the accuracy or use of such information. Furthermore, this technical information specifies semiconductor devices but promises no characteristics. No warranty or guarantee expressed or implied is made regarding delivery, performance or suitability. Specifications mentioned in this document are subject to change without notice. This document supersedes and replaces all information previously supplied and may be supersede by updates.

Disclaimer

In accordance with SEMIKRON's quality procedures, we hereby notify you that the Evaluation Board 2s SKYPER™ 32 should be considered as evaluation products only.

Evaluation products are experimental products and are therefore only intended for device evaluation. SEMIKRON does not represent or guarantee that a final version will be made available after device evaluation. Evaluation products are subject to the change service.

Although evaluation products have been manufactured using processes and procedures representative of final production, they have not been subjected to all of our normal quality audits and controls. Additionally, neither the product nor the manufacturing processes may have passed our internal qualification procedures.

IMPORTANT:

The evaluation boards are supplied without warranty of any kind, expressed, implied or statutory, including but not limited to, any implied warranty of merchantability or fitness for a particular purpose. Credit or replacement for evaluation products that fail to function will not be given nor will a failure analysis be performed. There is no entitlement to technical support for evaluation products.

Claims for damages and reimbursement of expenses on the part of the undersigned customer shall be excluded, regardless of the legal cause, especially claims in contract and in tort.

The liability exclusions shall not apply in cases of liability independent of the question of blame or negligence, especially claims under the German Product Liability Act in cases of wilful intent, gross negligence, or injury to life, limb or health and on account of a breach of major contractual obligations. Compensation for failure to comply with major contractual obligations shall be limited, however, to typical, foreseeable damages, unless wilful intent or gross negligence applies, or on account of liability for injury to life, limb or health. Any change in the burden of proof to the detriment of the undersigned customer shall not be associated with the aforesaid rulings

FOR SAFETY REASONS THE CUSTOMER IS NOT ALLOWED TO SELL EVALUATION PRODUCTS TO ANY END CUSTOMER OR ANY OTHER THIRD PARTY.

If the customer fails not to sell the evaluation products to any end customer or any other third party, then the customer shall indemnify SEMIKRON against all claims by the concerned end customer or third party in respect of any loss, damage or injury arising from the aforesaid reason.

Please note:

All values in this technical explanation are typical values. Typical values are the average values expected in large quantities and are provided for information purposes only. These values can and do vary in different applications. All operating parameters should be validated by user's technical experts for each application.

Application and Handling Instructions

- Please provide for static discharge protection during handling. As long as the hybrid driver is not completely assembled, the input terminals have to be short-circuited. Persons working with devices have to wear a grounded bracelet. Any synthetic floor coverings must not be statically chargeable. Even during transportation the input terminals have to be short-circuited using, for example, conductive rubber. Worktables have to be grounded. The same safety requirements apply to MOSFET- and IGBT-modules.
- Any parasitic inductances within the DC-link have to be minimised. Over-voltages may be absorbed by C- or RCD-snubber networks between main terminals for PLUS and MINUS of the power module.
- When first operating a newly developed circuit, SEMIKRON recommends to apply low collector voltage and load current in the beginning and to increase these values gradually, observing the turn-off behaviour of the free-wheeling diode and the turn-off voltage spikes generated across the IGBT. An oscillographic control will be necessary. Additionally, the case temperature of the module has to be monitored. When the circuit works correctly under rated operation conditions, short-circuit testing may be done, starting again with low collector voltage.
- It is important to feed any errors back to the control circuit and to switch off the device immediately in failure events. Repeated turn-on of the IGBT into a short circuit with a high frequency may destroy the device.
- The inputs of the hybrid driver are sensitive to over-voltage. Voltages higher than $V_S + 0,3V$ or below $-0,3V$ may destroy these inputs. Therefore, control signal over-voltages exceeding the above values have to be avoided.
- The connecting leads between hybrid driver and the power module should be as short as possible (max. 20cm), the driver leads should be twisted.

Further application support

Latest information is available at <http://www.semikron.com>. For design support please read the SEMIKRON Application Manual Power Modules available at <http://www.semikron.com>.

General Description

The Board 2s SKYPER™ 32 is an evaluation board for the IGBT module SEMiX® 2s (spring contact version). The board can be customized allowing adaptation and optimization to the used SEMiX® Module. The switching characteristic of the IGBT can be influenced through user settings, e.g. changing turn-on and turn-off speed by variation of R_{Gon} and R_{Goff} . Furthermore, it is possible to adjust the monitoring level and blanking time for the DSCP (see Technical Explanations SKYPER™ 32).

Please note:

This technical explanation is based on the Technical Explanations for SKYPER™ 32. Please read the Technical Explanations SKYPER™ 32 before using the Evaluation Board.

Board 2s SKYPER™ 32

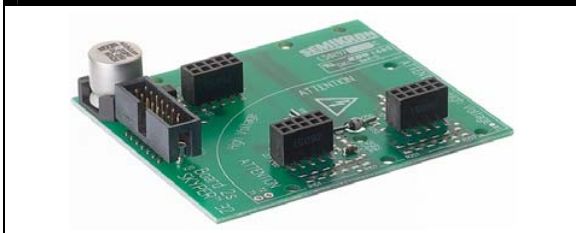

Board 2s SKYPER™ 32 - Technical Explanations

Dimensions

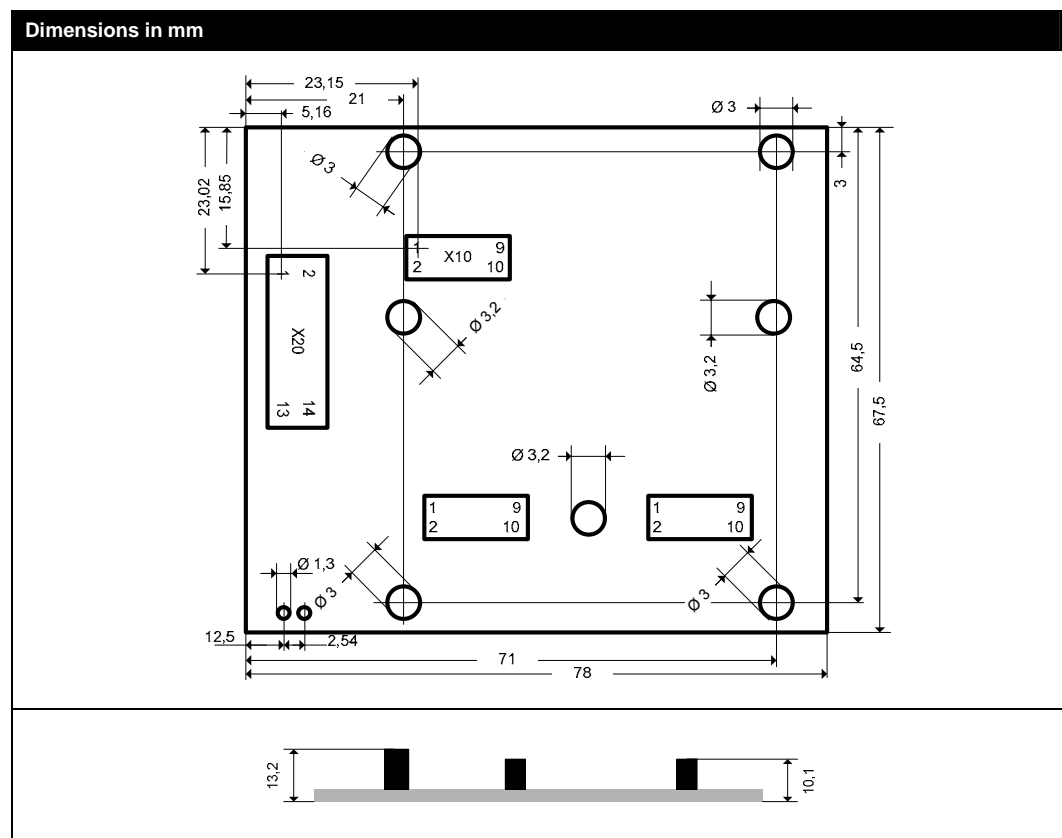

Component Placement Layout

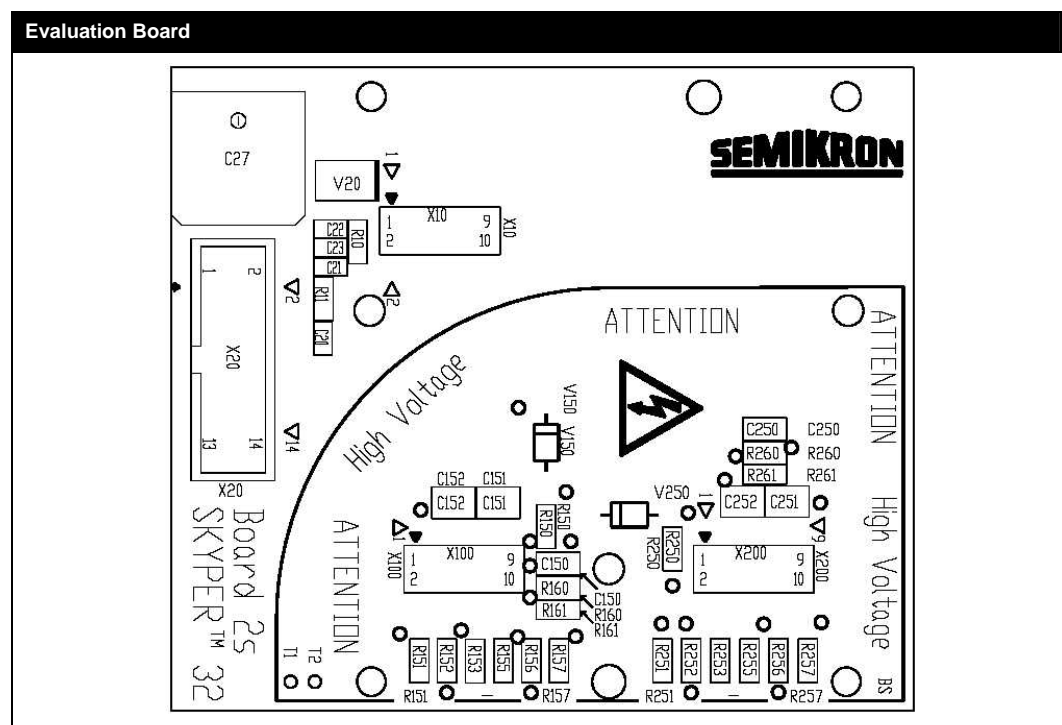

PIN Array

Connector X20 (ODU FLAKAFIX 511.068.803.014)

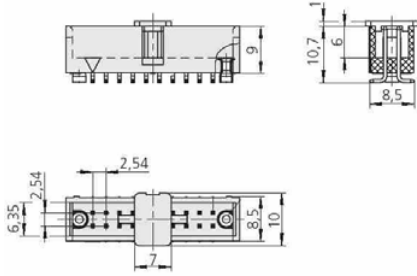

Product information of suitable female connectors and distributor contact information is available at e.g. <http://www.harting.com> (part number 09 18 514 6 813).

PIN	Signal	Function	Specification
X20:01	reserved		
X20:02	IF_HB_BOT	Switching signal input (BOTTOM switch)	Digital 15 V; 10 kOhm impedance; LOW = BOT switch off; HIGH = BOT switch on
X20:03	IF_nERROR_OUT	ERROR output	LOW = NO ERROR; open collector output; max. 30V / 15mA (external pull up resistor necessary)
X20:04	IF_HB_TOP	Switching signal input (TOP switch)	Digital 15 V; 10 kOhm impedance; LOW = TOP switch off; HIGH = TOP switch on
X20:05	reserved		
X20:06	reserved		
X20:07	reserved		
X20:08	IF_PWR_15P	Drive power supply	Stabilised +15V ±4%
X20:09	IF_PWR_15P	Drive power supply	Stabilised +15V ±4%
X20:10	IF_PWR_GND	GND for power supply and GND for digital signals	
X20:11	IF_PWR_GND	GND for power supply and GND for digital signals	
X20:12	reserved		
X20:13	reserved		
X20:14	reserved		

Please note:

The feature PRIM_ERROR_IN of the driver core is not available at the interface X20.

Setting Dynamic Short Circuit Protection

R _{CE} & C _{CE}			
Designation	Pattern Name	Setting	
R160	1206	R _{CE} Factory setting: not equipped	TOP
C150	1206	C _{CE} Factory setting: not equipped	TOP
R260	1206	R _{CE} Factory setting: not equipped	BOT
C250	1206	C _{CE} Factory setting: not equipped	BOT

Collector Series Resistance

R _{VCE}			
Designation	Pattern Name	Setting	
R150	MiniMELF	R _{VCE} * Factory setting: not equipped	TOP
R250	MiniMELF	R _{VCE} * Factory setting: not equipped	BOT

* 1200V IGBT operation: 0Ω
1700V IGBT operation: 1kΩ / 0,4W

Adaptation Gate Resistors

R _{Gon} & R _{Goff}			
Designation	Pattern Name	Setting	
R151, R152, R153 (parallel connected)	MiniMELF	R _{Gon} Factory setting: not equipped	TOP
R155, R156, R157 (parallel connected)	MiniMELF	R _{Goff} Factory setting: not equipped	TOP
R251, R252, R253 (parallel connected)	MiniMELF	R _{Gon} Factory setting: not equipped	BOT
R255, R256, R257 (parallel connected)	MiniMELF	R _{Goff} Factory setting: not equipped	BOT

Boost Capacitors

C _{boost15P} & C _{boost8N}			
Designation	Pattern Name	Setting	
C151	1210	C _{boost8N} Factory setting: 4,7µF/16V *	TOP
C152	1210	C _{boost15P} Factory setting: 2,2µF/25V *	TOP
C251	1210	C _{boost8N} Factory setting: 4,7µF/16V *	BOT
C252	1210	C _{boost15P} Factory setting: 2,2µF/25V *	BOT

* output charge pulse: 5µC

Temperature Signal

The temperature sensor inside the SEMiX® module is directly connected to contacting points T1 and T2. For details to the temperature sensor, see Modules Explanations SEMiX®.

Safety Warnings:



The contacting points T1 and T2 are not electrical isolated. Due to high voltage that may be present at the contacting points T1 and T2, some care must be taken in order to avoid accident. There is no cover or potential isolation that protect the high voltage sections / wires from accidental human contact.

Mounting Notes

The electrical connections between evaluation board and SEMiX® are realised via spring contacts integrated in SEMiX® power modules and via landing pads on the bottom side of the evaluation board.

Evaluation Board & Driver Core Mounting



1. Soldering of components (e.g. R_{Gon1}, R_{Goff1}, etc.) on adapter board.
2. Evaluation Board has to be fixed to the SEMiX® module (see "Mounting Instruction and Application Notes for SEMiX® IGBT modules" on SEMiX® product overview page at <http://www.semikron.com>).
3. Insert driver core into the box connector on evaluation board.

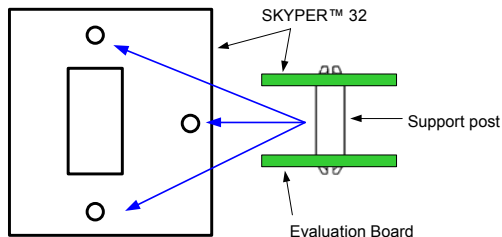

The connection between driver core and evaluation board should be mechanical reinforced by using support posts. The posts have to be spaced between driver core and evaluation board.

Product information of suitable support posts and distributor contact information is available at e.g. <http://www.richco-inc.com> (part number MSPM-8-01).

Schematics

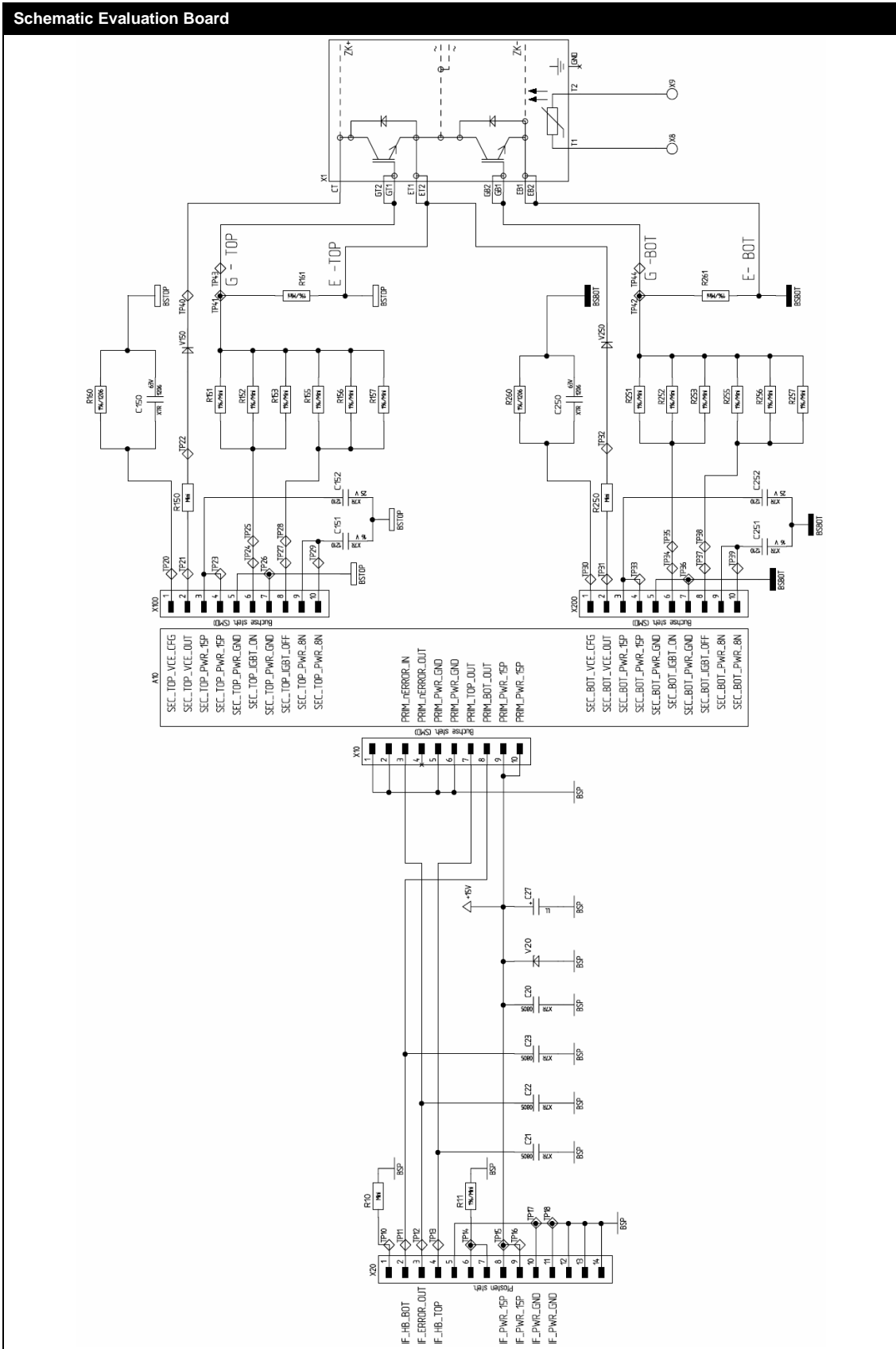

Layouts

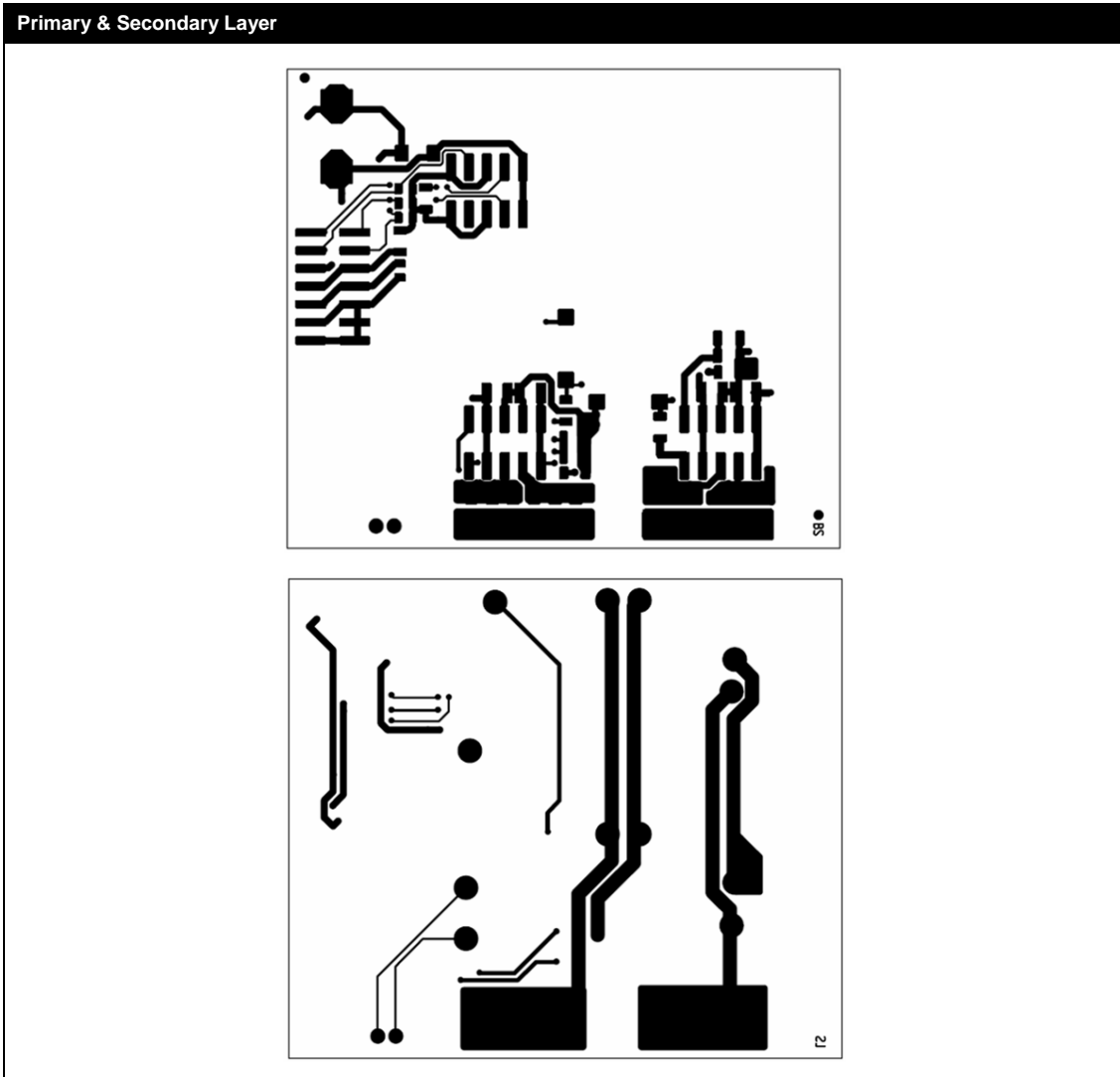

Parts List

Parts List Evaluation Board				
Count	Ref. Designator	Value	Pattern Name	Description
2	C151, C251	4,7µF	1210 (SMD)	Capacitor X7R
2	C152, C252	2,2µF	1210 (SMD)	Capacitor X7R
4	C20, C21, C22, C23	1nF	0805 (SMD)	Capacitor X7R
1	C27	220µF/35V	SMD	Longlife-Elko
1	R10	0,00Ohm	MiniMelf (SMD)	
3	R11, R161, R261	10,0KOhm	MiniMelf (SMD)	1%
2	V150, V250	BY203/20S		High Voltage Diode
1	V20	SMBJ15A	DO215AA (SMD)	Suppressor Diode
3	X10, X100, X200	RM2,54 10p.	SMD	Box Connector
1	X20	14p.	SMD	Connector

TP: Test Point
 Box Connector: SUYIN 254100FA010G200ZU