

**RoHS MC Series - TO-92**



**Agency Approvals**

Agency	Agency File Number
	E133083

**Pinout Designation**

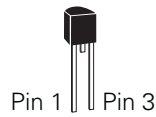

**Schematic Symbol**



**Description**

MC Series TO-92 are low capacitance SIDACtor® devices designed to protect broadband CPE equipment such as VoIP and DSL Modems from damaging overvoltage transients.

The series provides a through-hole solution that enables CPE equipment to comply with global regulatory standards while limiting the impact to broadband signals.

**Features and Benefits**

- Low voltage overshoot
- Low on-state voltage
- Does not degrade with use
- Fails short circuit when surged in excess of ratings
- 40% lower capacitance than our Baseband Protectors, for applications that demand greater signal integrity

**Applicable Global Standards**

- TIA-968-A
- TIA-968-B
- ITU K.20/21 Enhanced Level
- ITU K.20/21 Basic Level
- GR 1089 Intra-building
- IEC 61000-4-5
- YD/T 1082
- YD/T 993
- YD/T 950
- GR 1089 Inter-building

**Electrical Characteristics**

Part Number	Marking	$V_{DRM}$ @ $I_{DRM} = 5\mu A$	$V_S$ @ $100V/\mu s$	$I_H$	$I_S$	$I_T$	$V_T$ @ $I_T = 2.2$ Amps	Capacitance @ 1MHz, 2V bias	
		V min	V max	mA min	mA max	A max	V max	pF min	pF max
P0080ECMCLxxx	P0080ECMC	6	25	50	800	2.2	4	35	75
P0300ECMCLxxx	P0300ECMC	25	40	50	800	2.2	4	25	45
P0640ECMCLxxx	P0640ECMC	58	77	150	800	2.2	4	55	85
P0720ECMCLxxx	P0720ECMC	65	88	150	800	2.2	4	50	75
P0900ECMCLxxx	P0900ECMC	75	98	150	800	2.2	4	45	70
P1100ECMCLxxx	P1100ECMC	90	130	150	800	2.2	4	45	70
P1300ECMCLxxx	P1300ECMC	120	160	150	800	2.2	4	40	60
P1500ECMCLxxx	P1500ECMC	140	180	150	800	2.2	4	35	55
P1800ECMCLxxx	P1800ECMC	170	220	150	800	2.2	4	35	50
P2300ECMCLxxx	P2300ECMC	190	260	150	800	2.2	4	30	50
P2600ECMCLxxx	P2600ECMC	220	300	150	800	2.2	4	30	45
P3100ECMCLxxx	P3100ECMC	275	350	150	800	2.2	4	30	45
P3500ECMCLxxx	P3500ECMC	320	400	150	800	2.2	4	25	40

Notes:  
 - Absolute maximum ratings measured at  $T_a = 25^\circ C$  (unless otherwise noted).  
 - Devices are bi-directional (unless otherwise noted).  
 - **XXX** Part Number Suffix: 'AP' (Ammo Pack), or 'RP1' or 'RP2' (Reel Pack).

**Surge Ratings**

Series	$I_{PP}$										$I_{TSM}$ 50/60 Hz	di/dt	
	0.2x310 <sup>1</sup> 0.5x700 <sup>2</sup>	2x10 <sup>1</sup> 2x10 <sup>2</sup>	8x20 <sup>1</sup> 1.2x50 <sup>2</sup>	10x160 <sup>1</sup> 10x160 <sup>2</sup>	10x560 <sup>1</sup> 10x560 <sup>2</sup>	5x320 <sup>1</sup> 9x720 <sup>2</sup>	10x360 <sup>1</sup> 10x360 <sup>2</sup>	10x1000 <sup>1</sup> 10x1000 <sup>2</sup>	5x310 <sup>1</sup> 10x700 <sup>2</sup>				
	A min	A min	A min	A min	A min	A min	A min	A min	A min	A min			A/μs Max
C	50	500	400	200	150	200	175	100	200	30	500		

Notes:

- 1 Current waveform in μs
- 2 Voltage waveform in μs

- Peak pulse current rating ( $I_{PP}$ ) is repetitive and guaranteed for the life of the product.
- $I_{PP}$  ratings applicable over temperature range of -40°C to +85°C
- The device must initially be in thermal equilibrium with -40°C ≤  $T_J$  ≤ +150°C

**Thermal Considerations**

Package	Symbol	Parameter	Value	Unit
TO-92 	$T_J$	Operating Junction Temperature Range	-40 to +150	°C
	$T_S$	Storage Temperature Range	-65 to +150	°C
	$R_{θJA}$	Thermal Resistance: Junction to Ambient	90	°C/W

**V-I Characteristics**

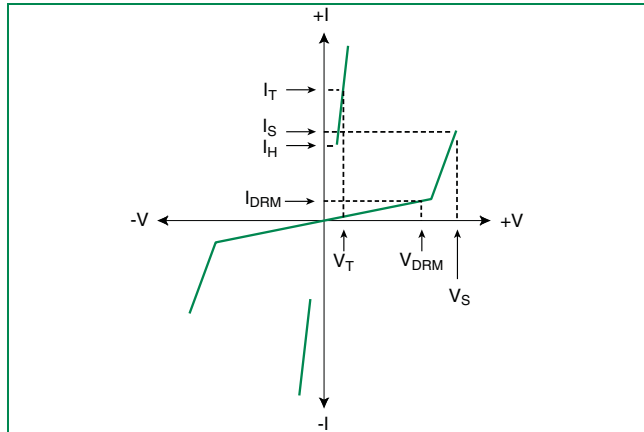

**$t_r \times t_d$  Pulse Waveform**

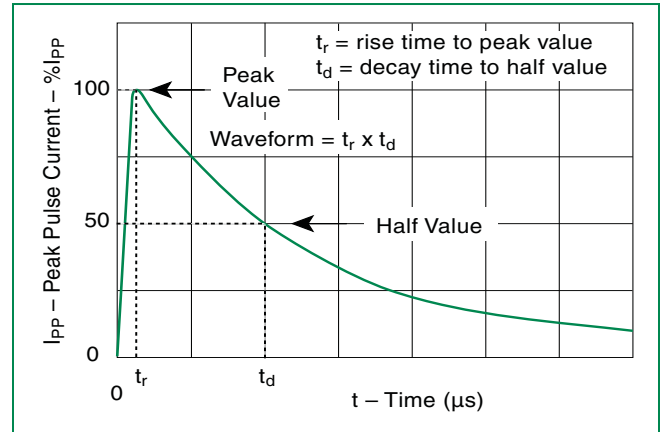

**Normalized  $V_S$  Change vs. Junction Temperature**

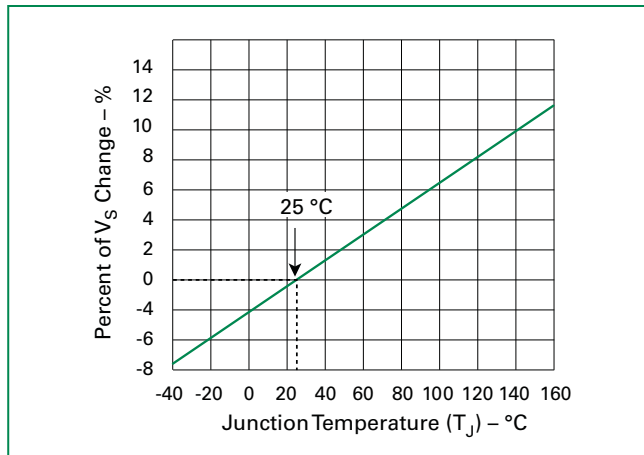

**Normalized DC Holding Current vs. Case Temperature**

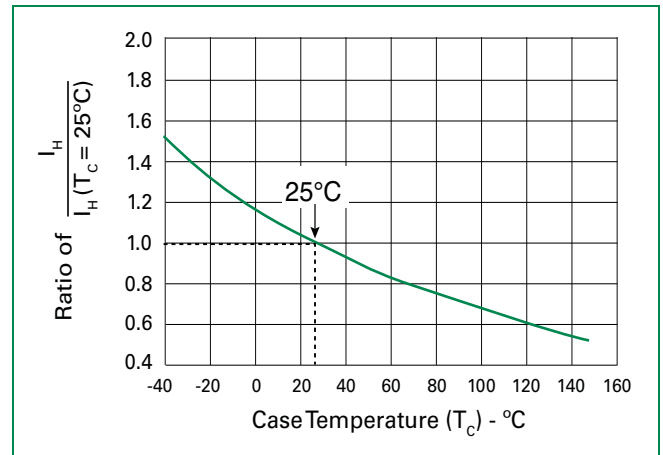

**Soldering Parameters**

Reflow Condition		Pb-Free assembly (see Fig. 1)
Pre Heat	- Temperature Min ( $T_{s(min)}$ )	+150°C
	- Temperature Max ( $T_{s(max)}$ )	+200°C
	- Time (Min to Max) ( $t_s$ )	60-180 secs.
Average ramp up rate (LiquidusTemp ( $T_L$ ) to peak)		3°C/sec. Max.
$T_{s(max)}$ to $T_L$ - Ramp-up Rate		3°C/sec. Max.
Reflow	- Temperature ( $T_L$ ) (Liquidus)	+217°C
	- Temperature ( $t_L$ )	60-150 secs.
Peak Temp ( $T_p$ )		+260(+0/-5)°C
Time within 5°C of actual Peak Temp ( $t_p$ )		30 secs. Max.
Ramp-down Rate		6°C/sec. Max.
Time 25°C to Peak Temp ( $T_p$ )		8 min. Max.
Do not exceed		+260°C



**Physical Specifications**

<b>Lead Material</b>	Copper Alloy
<b>Terminal Finish</b>	100% Matte-Tin Plated
<b>Body Material</b>	UL recognized epoxy meeting flammability classification 94V-0

**Environmental Specifications**

<b>High Temp Voltage Blocking</b>	80% Rated $V_{DRM}$ ( $V_{AC}$ Peak) +125°C or +150°C, 504 or 1008 hrs. MIL-STD-750 (Method 1040) JEDEC, JESD22-A-101
<b>Temp Cycling</b>	-65°C to +150°C, 15 min. dwell, 10 up to 100 cycles. MIL-STD-750 (Method 1051) EIA/JEDEC, JESD22-A104
<b>Biased Temp &amp; Humidity</b>	52 $V_{DC}$ (+85°C) 85%RH, 504 up to 1008 hrs. EIA/JEDEC, JESD22-A-101
<b>High Temp Storage</b>	+150°C 1008 hrs. MIL-STD-750 (Method 1031) JEDEC, JESD22-A-101
<b>Low Temp Storage</b>	-65°C, 1008 hrs.
<b>Thermal Shock</b>	0°C to +100°C, 5 min. dwell, 10 sec. transfer, 10 cycles. MIL-STD-750 (Method 1056) JEDEC, JESD22-A-106
<b>Autoclave (Pressure Cooker Test)</b>	+121°C, 100%RH, 2atm, 24 up to 168 hrs. EIA/JEDEC, JESD22-A-102
<b>Resistance to Solder Heat</b>	+260°C, 30 secs. MIL-STD-750 (Method 2031)
<b>Moisture Sensitivity Level</b>	85%RH, +85°C, 168 hrs., 3 reflow cycles (+260°C Peak). JEDEC-J-STD-020, Level 1

**Part Numbering**

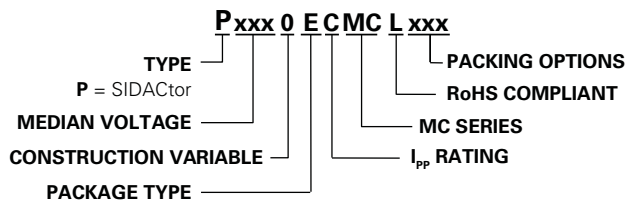

**Part Marking**

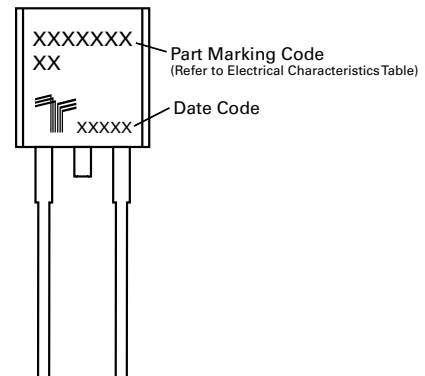

**Packing Options**

Package Type	Description	Packing Options Quantity	Added Suffix	Lead Spacing	Industry Standard
E	TO-92 Tape and Reel Pack	2000	RP1	0.1 inch (2.54mm)	EIA-481-D
	TO-92 Ammo Pack		AP	(Not applicable)	EIA-468-B
	TO-92 Bulk Pack		N/A	(Not applicable)	N/A

**Dimensions – TO-92**

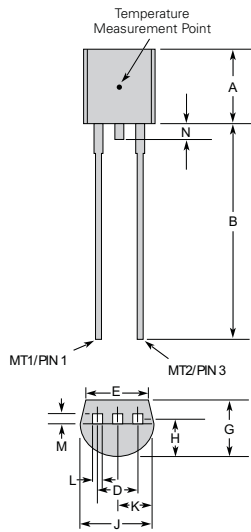

	Inches		Millimeters	
	Min	Max	Min	Max
<b>A</b>	0.176	0.196	4.47	4.98
<b>B</b>	0.500		12.70	
<b>D</b>	0.095	0.105	2.41	2.67
<b>E</b>	0.150		3.81	
<b>G</b>	0.135	0.145	3.43	3.68
<b>H</b>	0.088	0.096	2.23	2.44
<b>J</b>	0.176	0.186	4.47	4.73
<b>K</b>	0.088	0.096	2.23	2.44
<b>L</b>	0.013	0.019	0.33	0.48
<b>M</b>	0.013	0.017	0.33	0.43
<b>N</b>		0.60		1.52

All leads are insulated from case. Case is electrically non-conductive. (Rated at 1600 V<sub>(AC) RMS</sub> for one minute from leads to case over the operating temperature range.)

Mold flash shall not exceed 0.13 mm per side.

The TO-92 is designed to meet mechanical standards as set forth in JEDEC publication number 95.

**Ammo Pack Specification – TO-92**

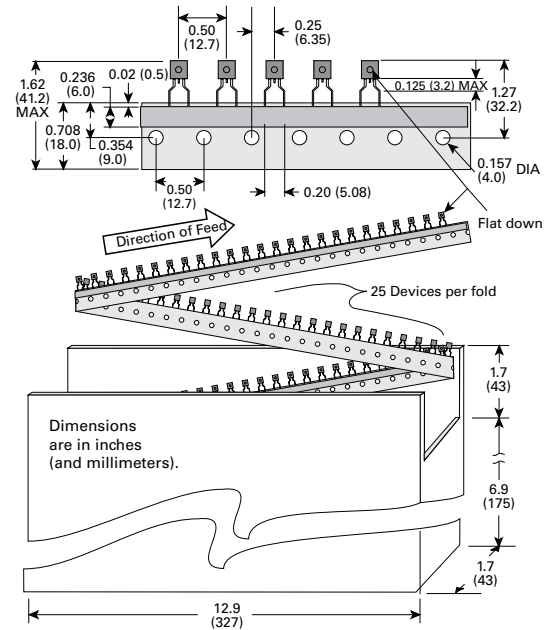

**Tape and Reel Specification – TO-92**

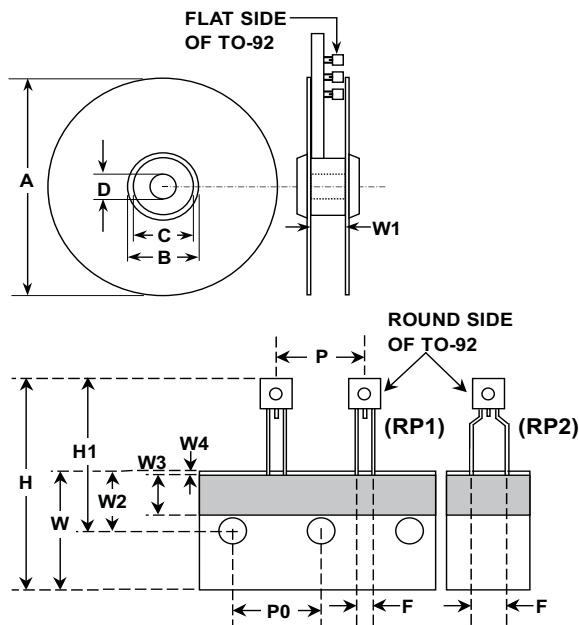

	Inches		Millimeters	
	Min	Max	Min	Max
<b>A</b>	N/A	14.173	N/A	360.0
<b>B</b>	4.016	N/A	102.0	N/A
<b>C</b>	3.386	N/A	86.0	N/A
<b>D</b>	0.795	N/A	20.2	N/A
<b>W1</b>	1.181	1.968	30.0	50.0
<b>P</b>	0.496	0.504	12.60	12.80
<b>P0</b>	0.498	0.502	12.65	12.75
<b>F(for RP1)</b>	0.090	0.110	2.29	2.80
<b>F(for RP2)</b>	0.182	0.244	4.63	6.19
<b>H</b>	N/A	1.673	N/A	42.50
<b>H1</b>	N/A	1.270	N/A	32.26
<b>W</b>	0.674	0.763	17.12	19.38
<b>W2</b>	0.354	0.370	8.25	9.75
<b>W3</b>	0.236	N/A	6.00	N/A
<b>W4</b>	0.020	N/A	0.50	N/A