



STEVAL-TDR016V1

RF power amplifier using 1 x PD55015E N-channel enhancement-mode lateral MOSFETs

Features

- Excellent thermal stability
- Frequency: 155 - 165 MHz
- Supply voltage: 20 V
- Output power: 30 W
- Power gain: 14.7 ± 0.3 dB
- Efficiency: 60% - 72%
- Load mismatch: 20:1
- Beo free amplifier

Application

- Marine radio

Description

The STEVAL-TDR016V1 is a common source N-channel enhancement-mode lateral field effect RF power amplifier designed for VHF marine radio application.

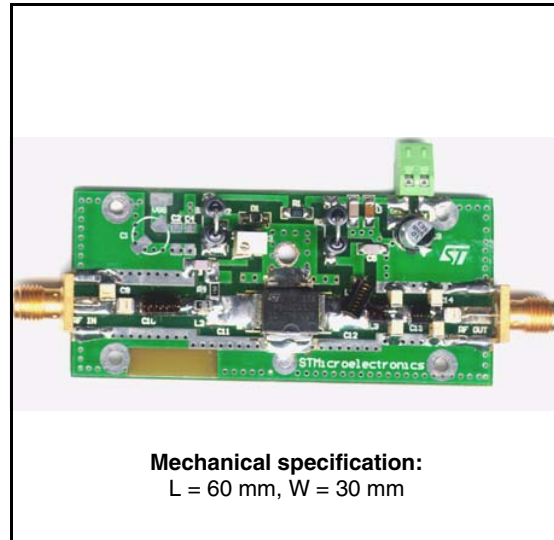

Table 1. Device summary

Order code
STEVAL-TDR016V1

Contents

1	Electrical data	3
	1.1 Maximum ratings	3
2	Electrical characteristics	3
3	Typical performance	4
4	Circuit layout	6
5	Mounting indications	7
6	Package mechanical data	8
7	Revision history	11

1 Electrical data

1.1 Maximum ratings

Table 2. Absolute maximum ratings

Symbol	Parameter	Value	Unit
V_{DD}	Supply voltage	24	V
I_D	Drain current	3	A
P_{DISS}	Power dissipation	25	W
T_{CASE}	Operating case temperature	-20 to +85	°C
T_A	Max. ambient temperature	55	°C

2 Electrical characteristics

$T_A = +25\text{ °C}$, $V_{DD} = 20\text{V}$, $I_{DQ} = 150\text{ mA}$

Table 3. Electrical specification

Symbol	Test conditions	Min.	Typ.	Max.	Unit
Freq	Frequency range	155		165	MHz
P_{OUT}			30		W
Gain	@ $P_{OUT} = 30\text{W}$		14.7		dB
ND	@ $P_{OUT} = 30\text{W}$	60			%
Gain Flatness	@ $P_{OUT} = 30\text{W}$			± 0.3	dB
H2	2 ND Harmonic @ $P_{OUT} = 30\text{ W}$		-29	-25	dBc
H3	3 RD Harmonic @ $P_{OUT} = 30\text{ W}$		-52	-50	dBc
VSWR	Load mismatch all phases @ $P_{OUT} = 30\text{ W}$			20:1	

3 Typical performance

Figure 1. P_{OUT} vs P_{in} and frequency @ $V_{dd} = 20\text{ V}$

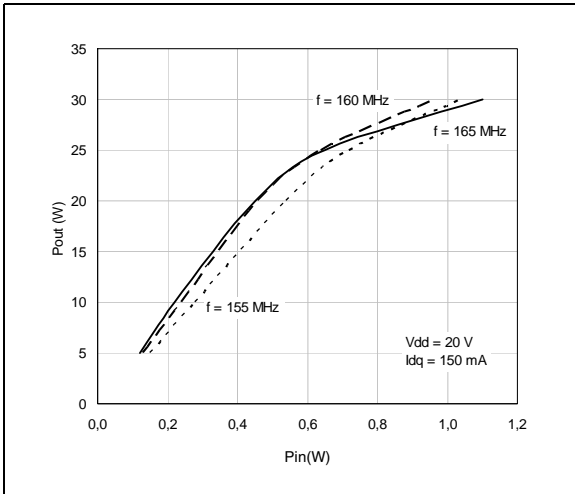

Figure 2. Efficiency vs P_{OUT} and frequency @ $V_{dd} = 20\text{ V}$

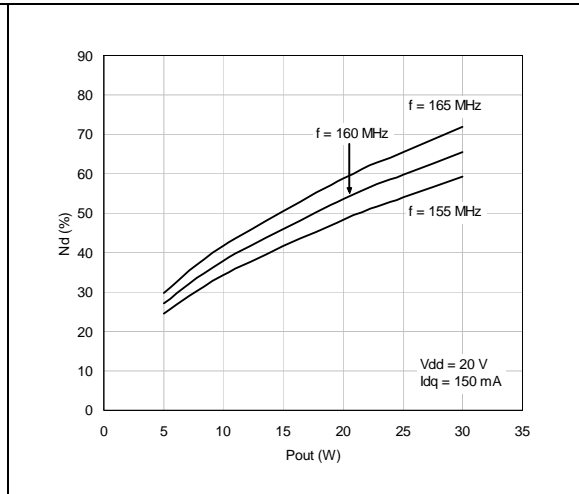

Figure 3. Gain vs P_{OUT} and frequency @ $V_{dd} = 20\text{ V}$

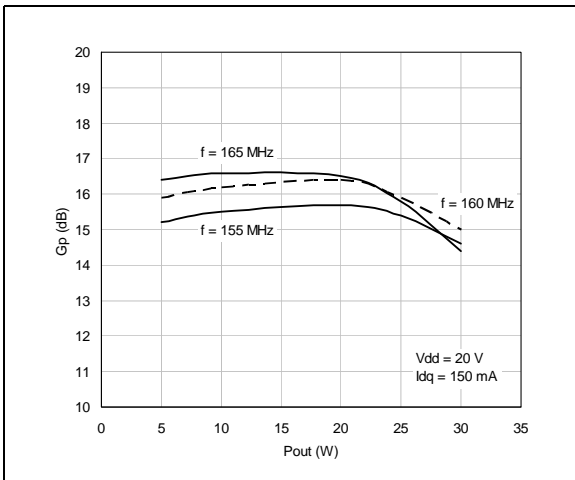

Figure 4. Harmonics vs frequency @ $V_{dd} = 20\text{ V}$

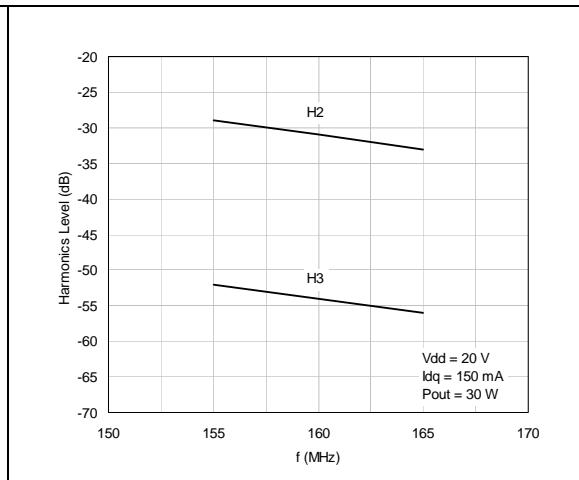

Figure 5. P_{OUT} and current vs drain voltage @ $f = 165$ MHz

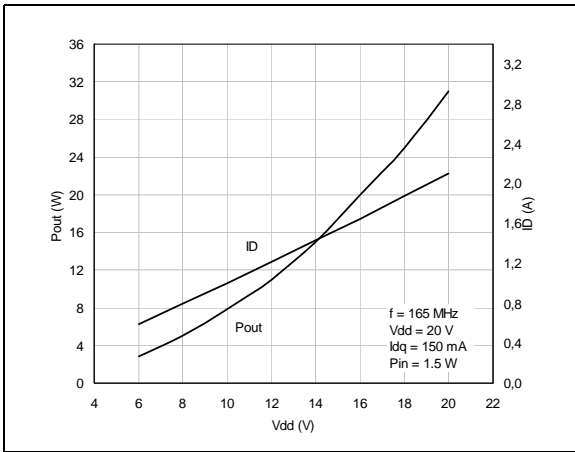

Figure 6. P_{OUT} and current vs drain voltage @ $f = 155$ MHz

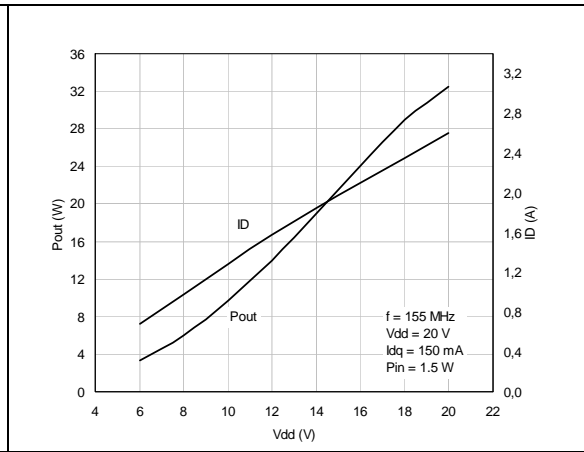

Figure 7. P_{OUT} vs pin and frequency @ $V_{DD} = 13.6$ V

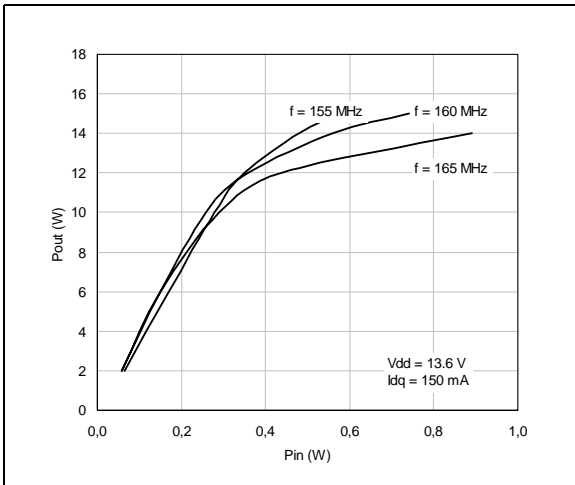

Figure 8. Efficiency vs P_{OUT} and frequency @ $V_{DD} = 13.6$ V

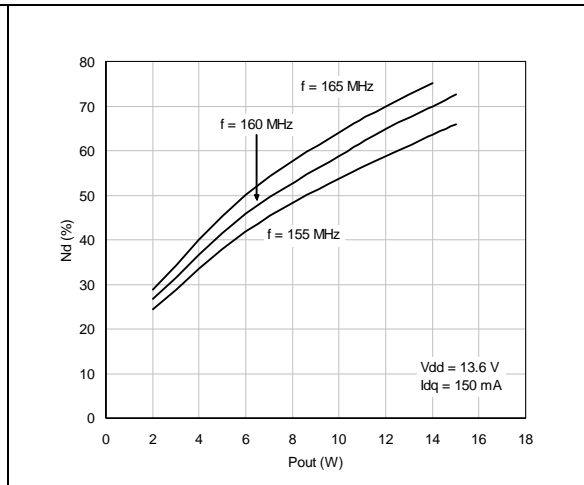

Figure 9. Gain vs P_{OUT} and frequency @ V_{DD}= 13.6 V

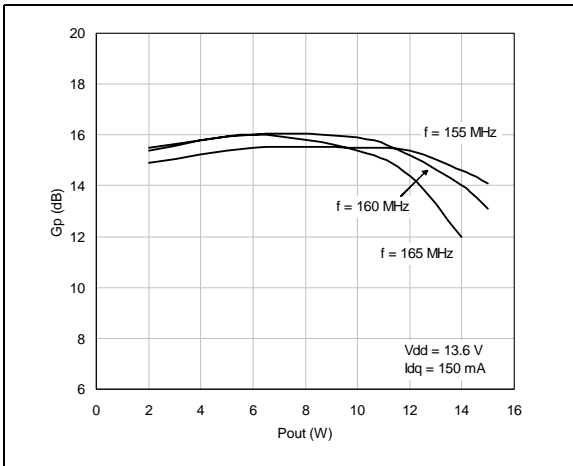
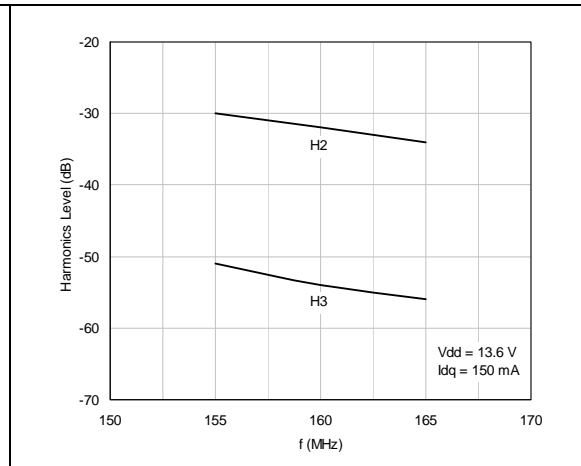
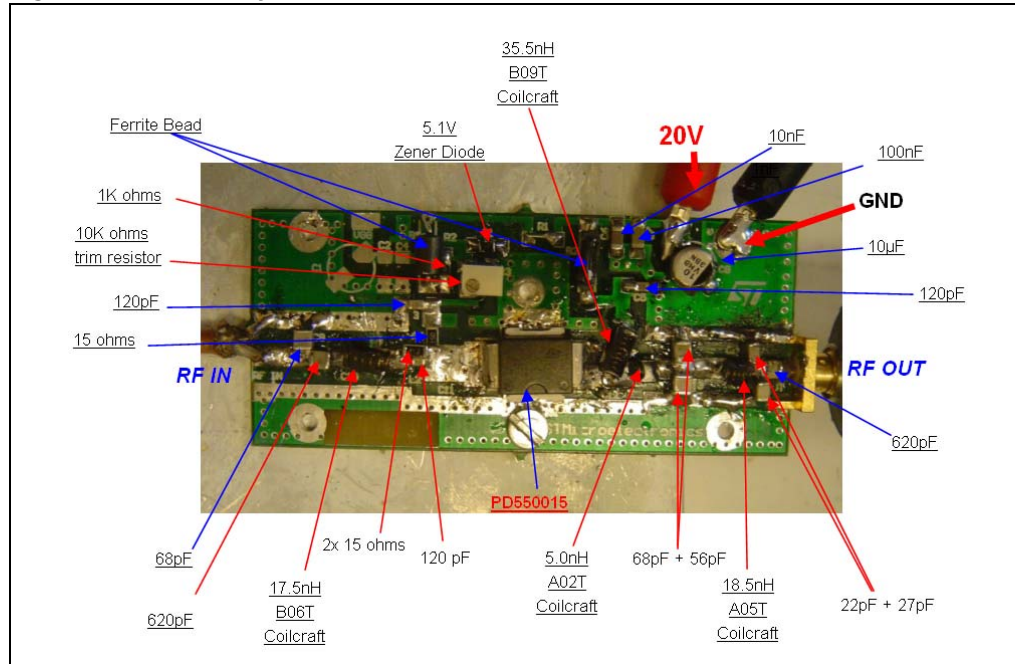

Figure 10. Harmonics vs frequency @ V_{DD} = 13.6 V



4 Circuit layout

Figure 11. Circuit layout



5 Mounting indications

Figure 12. PowerSO-10 mounting indications

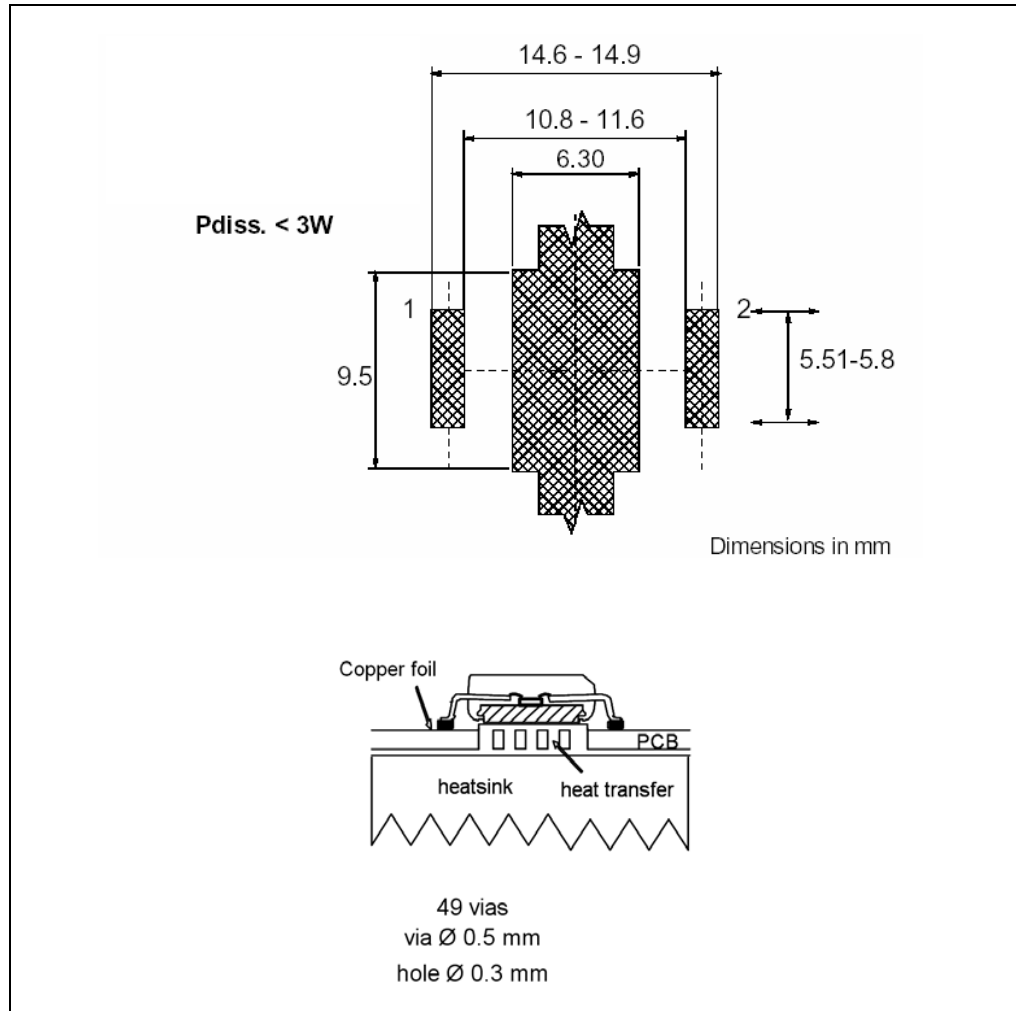

6 Package mechanical data

In order to meet environmental requirements, ST offers these devices in different grades of ECOPACK[®] packages, depending on their level of environmental compliance. ECOPACK[®] specifications, grade definitions and product status are available at: www.st.com. ECOPACK is an ST trademark.

Table 4. PowerSO-10RF formed lead (Gull wing) mechanical data

Dim.	mm.			Inch		
	Min.	Typ.	Max.	Min.	Typ.	Max.
A1	0	0.05	0.1	0.	0.0019	0.0038
A2	3.4	3.5	3.6	0.134	0.137	0.142
A3	1.2	1.3	1.4	0.046	0.05	0.054
A4	0.15	0.2	0.25	0.005	0.007	0.009
a		0.2			0.007	
b	5.4	5.53	5.65	0.212	0.217	0.221
c	0.23	0.27	0.32	0.008	0.01	0.012
D	9.4	9.5	9.6	0.370	0.374	0.377
D1	7.4	7.5	7.6	0.290	0.295	0.298
E	13.85	14.1	14.35	0.544	0.555	0.565
E1	9.3	9.4	9.5	0.365	0.37	0.375
E2	7.3	7.4	7.5	0.286	0.292	0.294
E3	5.9	6.1	6.3	0.231	0.24	0.247
F		0.5			0.019	
G		1.2			0.047	
L	0.8	1	1.1	0.030	0.039	0.042
R1			0.25			0.01
R2		0.8			0.031	
T	2 deg	5 deg	8 deg	2 deg	5 deg	8 deg
T1		6 deg			6 deg	
T2		10 deg			10 deg	

Note: Resin protrusions not included (max value: 0.15 mm per side)

Figure 13. Package dimensions

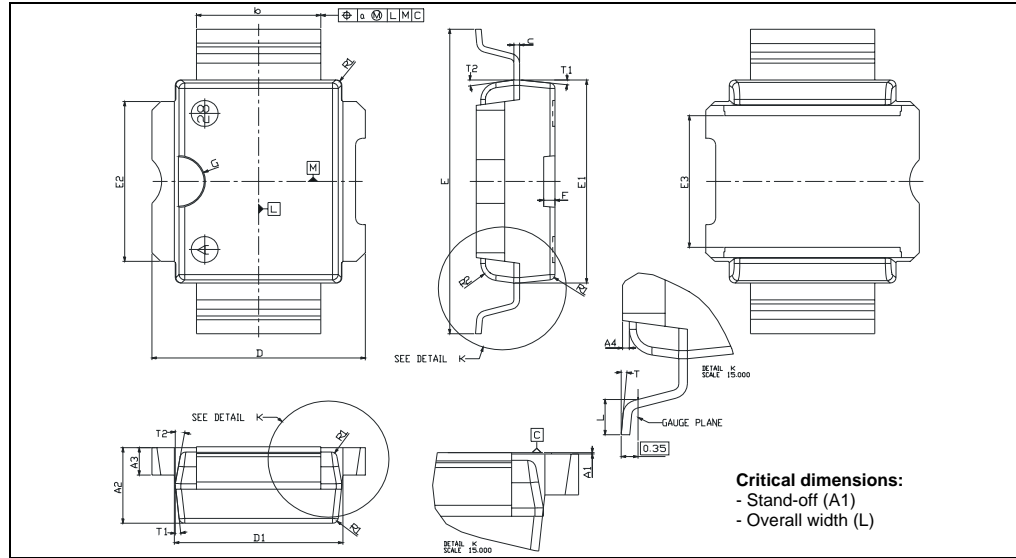
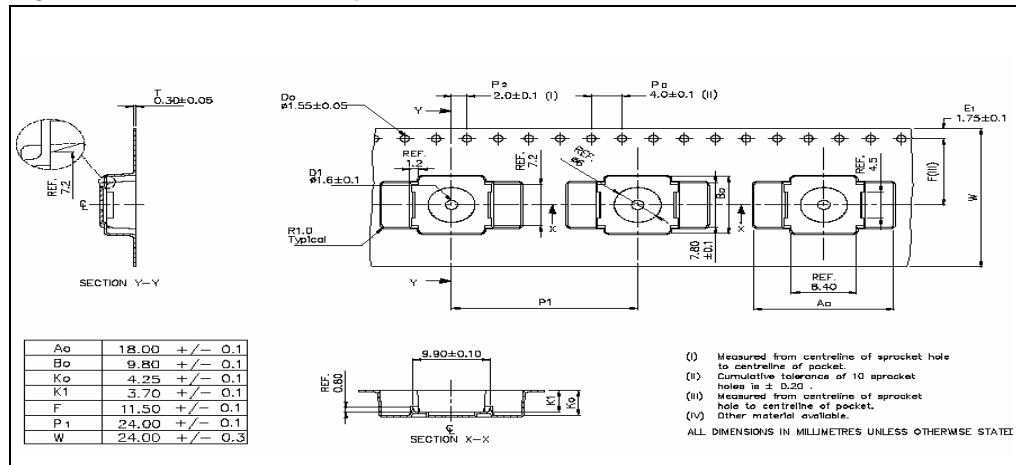

Figure 14. PowerSO-10RF tape and reel



7 Revision history

Table 5. Document revision history

Date	Revision	Changes
27-Sep-2010	1	Initial release.

Please Read Carefully:

Information in this document is provided solely in connection with ST products. STMicroelectronics NV and its subsidiaries ("ST") reserve the right to make changes, corrections, modifications or improvements, to this document, and the products and services described herein at any time, without notice.

All ST products are sold pursuant to ST's terms and conditions of sale.

Purchasers are solely responsible for the choice, selection and use of the ST products and services described herein, and ST assumes no liability whatsoever relating to the choice, selection or use of the ST products and services described herein.

No license, express or implied, by estoppel or otherwise, to any intellectual property rights is granted under this document. If any part of this document refers to any third party products or services it shall not be deemed a license grant by ST for the use of such third party products or services, or any intellectual property contained therein or considered as a warranty covering the use in any manner whatsoever of such third party products or services or any intellectual property contained therein.

UNLESS OTHERWISE SET FORTH IN ST'S TERMS AND CONDITIONS OF SALE ST DISCLAIMS ANY EXPRESS OR IMPLIED WARRANTY WITH RESPECT TO THE USE AND/OR SALE OF ST PRODUCTS INCLUDING WITHOUT LIMITATION IMPLIED WARRANTIES OF MERCHANTABILITY, FITNESS FOR A PARTICULAR PURPOSE (AND THEIR EQUIVALENTS UNDER THE LAWS OF ANY JURISDICTION), OR INFRINGEMENT OF ANY PATENT, COPYRIGHT OR OTHER INTELLECTUAL PROPERTY RIGHT.

UNLESS EXPRESSLY APPROVED IN WRITING BY AN AUTHORIZED ST REPRESENTATIVE, ST PRODUCTS ARE NOT RECOMMENDED, AUTHORIZED OR WARRANTED FOR USE IN MILITARY, AIR CRAFT, SPACE, LIFE SAVING, OR LIFE SUSTAINING APPLICATIONS, NOR IN PRODUCTS OR SYSTEMS WHERE FAILURE OR MALFUNCTION MAY RESULT IN PERSONAL INJURY, DEATH, OR SEVERE PROPERTY OR ENVIRONMENTAL DAMAGE. ST PRODUCTS WHICH ARE NOT SPECIFIED AS "AUTOMOTIVE GRADE" MAY ONLY BE USED IN AUTOMOTIVE APPLICATIONS AT USER'S OWN RISK.

Resale of ST products with provisions different from the statements and/or technical features set forth in this document shall immediately void any warranty granted by ST for the ST product or service described herein and shall not create or extend in any manner whatsoever, any liability of ST.

ST and the ST logo are trademarks or registered trademarks of ST in various countries.

Information in this document supersedes and replaces all information previously supplied.

The ST logo is a registered trademark of STMicroelectronics. All other names are the property of their respective owners.

© 2010 STMicroelectronics - All rights reserved

STMicroelectronics group of companies

Australia - Belgium - Brazil - Canada - China - Czech Republic - Finland - France - Germany - Hong Kong - India - Israel - Italy - Japan - Malaysia - Malta - Morocco - Philippines - Singapore - Spain - Sweden - Switzerland - United Kingdom - United States of America

www.st.com

