

## 5A Low Dropout Fast Response Positive Adjustable Regulator and Fixed 3.3V

### Features

- Fast Transient Response
- Guaranteed Dropout Voltage at Multiple Currents
- Load Regulation :0.05% Typ.
- Line Regulation : 0.03% Typ.
- Low Dropout Voltage: 1.3V Typ. at  $I_{OUT} = 5A$
- Trimmed Current Limit : 5A Typ. at  $T_j = 125\text{ }^\circ\text{C}$
- On-Chip Thermal Limiting : 150  $^\circ\text{C}$  Typ.
- Standard 3-pin TO-220, TO-252 and TO-263 Power Packages

applications, the APL1084 has been optimized. The output available voltage range of adjustable version is from 1.25~5.75V with an input supply below 7V, and the fixed 3.3V output voltage device is also available. Current limit is trimmed to ensure specified output current and controlled short-circuit current. On-chip thermal limiting provides protection against any combination of overload that would create excessive junction temperatures. The APL1084 is available in both the through-hole and surface mount versions of the industry standard 3-pin TO-220, TO-252 and TO-263 power packages.

### Applications

- Pentium™ Processor Supplies
- powerPC™ Supplies
- Low Voltage Logic Supplies
- Battery-Powered Circuitry
- Post Regulator for Switching Power Supply

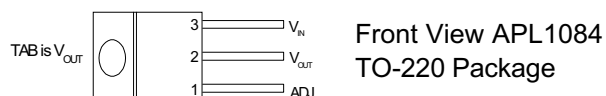
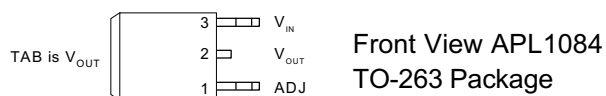
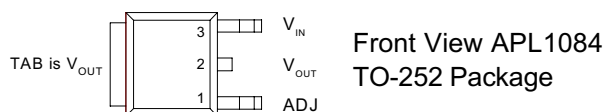

### Pin Description



### General Description

The APL1084 is a low dropout three-terminal adjustable regulator with 5A output current capability. In order to obtain lower dropout voltage and faster transient response, which is critical for low voltage

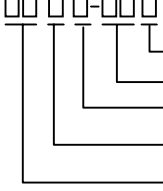
### Ordering Information

<p>APL1084 - □□ □ □ □ □ □ □</p>  <p>Lead Free Code                  Handling Code                  Temp. Range                  Package Code                  Voltage Code</p>	<p>Package Code                  F : TO-220    G : TO-263    U : TO-252    Z : TO-264</p> <p>Temp. Range                  C : 0 to 70 <math>^\circ\text{C}</math></p> <p>Handling Code                  TU : Tube                      TR : Tape &amp; Reel</p> <p>Voltage Code :                  33 : 3.3V                      Blank : Adjustable Version</p> <p>Lead Free Code                  L : Lead Free Device    Blank : Original Device</p>
<p>APL1084 :  XXXXX - Date Code</p>	<p>APL1084-33 :  XXXXX - Date Code</p>

ANPEC reserves the right to make changes to improve reliability or manufacturability without notice, and advise customers to obtain the latest version of relevant information to verify before placing orders.

## Absolute Maximum Ratings

Symbol	Parameter	Rating	Unit
$V_I$	Input Voltage	7	V
$T_J$	Operating Junction Temperature Range Control Section Power Transistor	0 to 125 0 to 150	°C
$T_{STG}$	Storage Temperature Range	-65 to +150	°C
$T_L$	Lead Temperature (Soldering, 10 second)	260	°C

## Electrical Characteristics

Symbol	Parameter	Test Conditions	APL1084			Unit
			Min.	Typ.	Max.	
$V_{REF}$	Reference Voltage APL1084	$1.5V \leq (V_{IN} - V_{OUT}) \leq 5.75V$ , $10mA \leq I_{OUT} \leq 5A$ , $T_J = 0 \sim 125^\circ C$	1.225(-2%)	1.250	1.275(+2%)	V
$V_{OUT}$	Output Voltage APL1084-3.3	$10mA \leq I_{OUT} \leq 5A$ , $4.75V \leq V_{IN} \leq 7V$ , $T_J = 0 \sim 125^\circ C$	3.235(-2%)	3.300	3.365(+2%)	V
$REG_{LINE}$	Line Regulation APL1084 APL1084-3.3	$T_J = 0 \sim 125^\circ C$ , (Notes 1) $2.75V \leq V_{IN} \leq 7V$ , $I_{OUT} = 10mA$ , $4.75V \leq V_{IN} \leq 7V$ , $I_{OUT} = 0mA$ ,		0.03	0.2	%
$REG_{LOAD}$	Load Regulation APL1084 APL1084-3.3	$T_J = 25^\circ C$ , (Notes 1) $(V_{IN} - V_{OUT}) = 3V$ , $10mA \leq I_{OUT} \leq 5A$ $V_{IN} = 5V$ , $0mA \leq I_{OUT} \leq 5A$		0.05 0.05	0.3 0.5	%
$V_D$	Dropout Voltage	$\Delta V_{REF} = 1\%$ , $I_{OUT} = 3A$ , $T_J = 0 \sim 125^\circ C$ $\Delta V_{REF} = 1\%$ , $I_{OUT} = 5A$ , $T_J = 0 \sim 125^\circ C$		1.2 1.3	1.4 1.5	V
$I_{LIMIT}$	Current Limit	$(V_{IN} - V_{OUT}) = 1.7V$ , $T_J = 25^\circ C$ $T_J = 125^\circ C$ $(V_{IN} - V_{OUT}) = 3V$ , $T_J = 25^\circ C$ $T_J = 125^\circ C$	6.0 5.0 6.5 5.5	7.6 6.0 8.2 6.5		A
$I_{ADJ}$	Adjust Pin Current APL1084	$(V_{IN} - V_{OUT}) = 3V$ , $I_{OUT} = 10mA$ , $T_J = 0 \sim 125^\circ C$		60	120	$\mu A$
$\Delta I_{ADJ}$	Adjust Pin Current Change APL1084	$1.5V \leq (V_{IN} - V_{OUT}) \leq 5.75V$ , $10mA \leq I_{OUT} \leq 5A$		0.2	5	$\mu A$
$I_{LMIN}$	Minimum Load Current APL1084	$1.5V \leq (V_{IN} - V_{OUT}) \leq 5.75V$ , $T_J = 0 \sim 125^\circ C$		2	10	mA
$I_Q$	Quiescent Current APL1084-3.3	$V_{IN} = 5V$		8	13	mA
PSRR	Ripple Rejection APL1084 APL1084-3.3	$F = 120Hz$ , $C_{OUT} = 22\mu F$ , Tant. , $(V_{IN} - V_{OUT}) = 3V$ , $I_{OUT} = 5A$ $F = 120Hz$ , $C_{OUT} = 22\mu F$ , Tant. , $(V_{IN} = 6.3V$ , $I_{OUT} = 5A$	60			dB
$L_S$	Long -Term Stability	$T_J = 125^\circ C$ , 1000Hrs.		0.03	1.0	%

## Electrical Characteristics (Cont.)

Symbol	Parameter	Test Conditions	APL1084			Unit
			Min.	Typ.	Max.	
$V_N$	RMS Output Noise(% of $V_{OUT}$ )	$T_J=25^{\circ}\text{C}, 10\text{Hz}\leq F\leq 10\text{kHz}$		0.003		%
$\theta_{th,J-TAB}$	Thermal Resistance Junction-to-Case, at TAB	(NOTE 2)		6.0		$^{\circ}\text{C}/\text{W}$
$\theta_{th,J-AMB}$	Thermal Resistance Junction-to-Ambient	TO-263 TO-252		50 62.5		$^{\circ}\text{C}/\text{W}$

NOTE 1: See thermal regulation specifications for changes in output voltage due to heating effects. Load and line regulations are measured at a constant junction temperature by low duty cycle pulse testing.

NOTE 2 :The value could be varied when heat sink size is different. Use larger heat sink or larger PCB size , which improves  $\theta_{th,TAB-A}$  to improve overall thermal resistance ( $\theta_{th,J-A}$ ).

## Application Circuits

### Typical Regulator

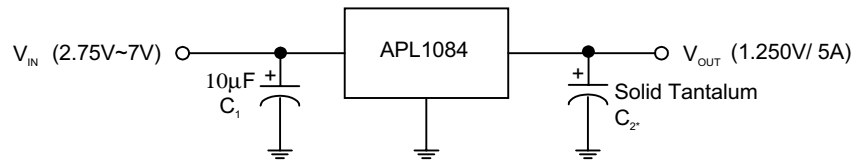

### 5V to 3.3V Regulator

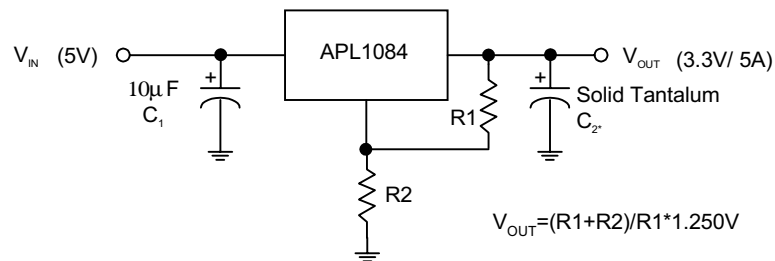

\* Required for stability

APL1084:  $C_2=10\mu\text{F}$

\* R1 is typically in range of 100Ω to 120Ω

## Typical Characteristics

Dropout Voltage vs Output Current

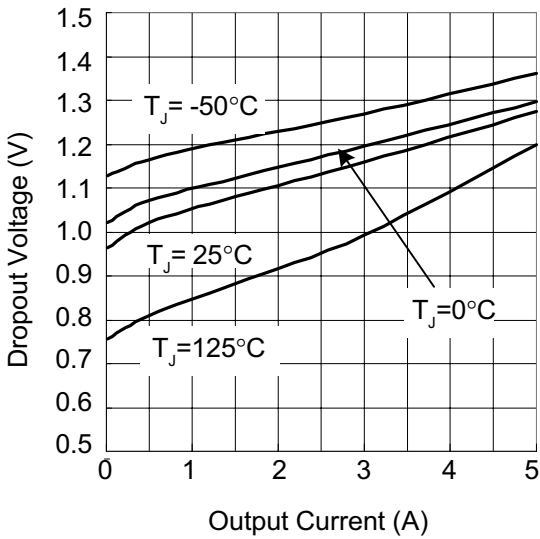

Short-Circuit Current vs Temperature

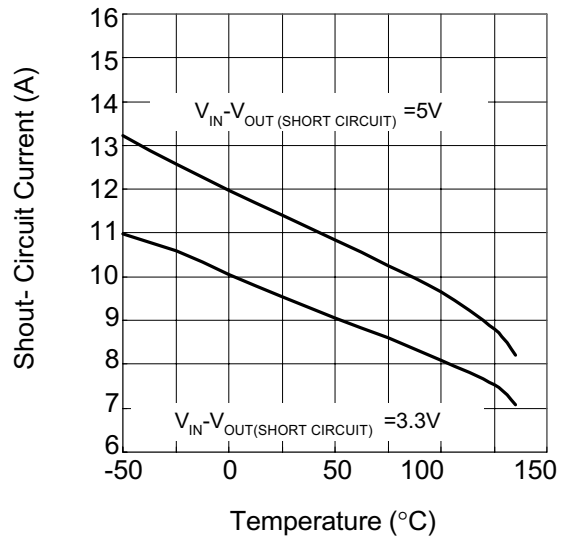

Load Regulation vs Temperature

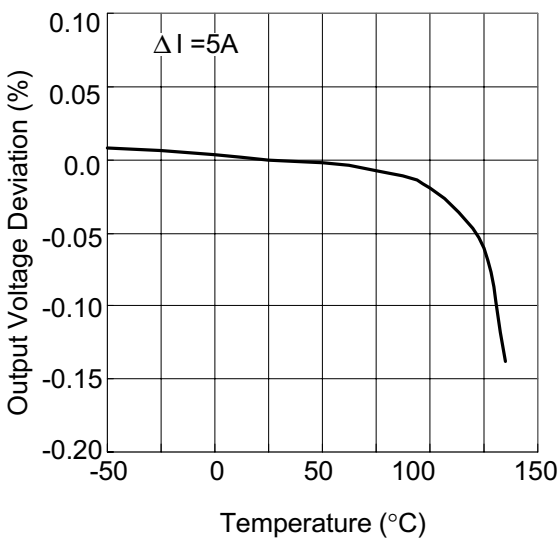

Reference Voltage vs Temperature

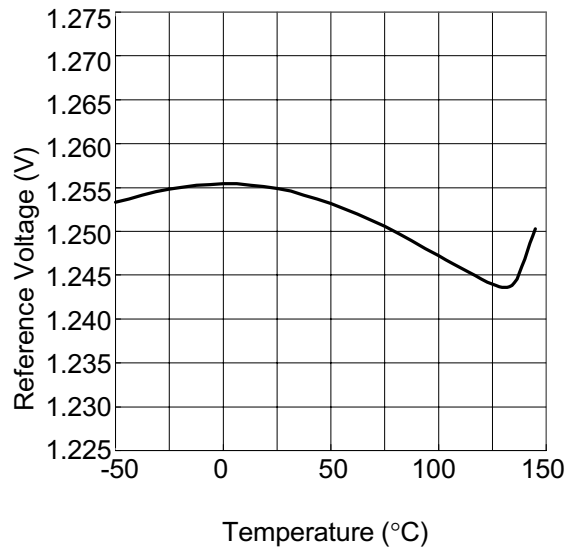

Typical Characteristics (Cont.)

Minimum Load Current vs Temperature

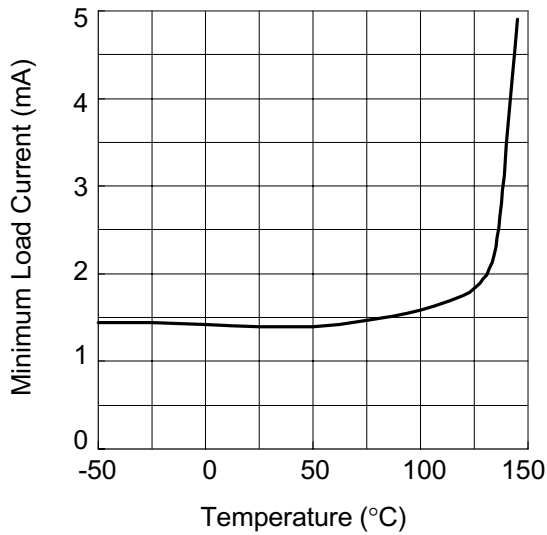

Adjust Pin Current vs Temperature

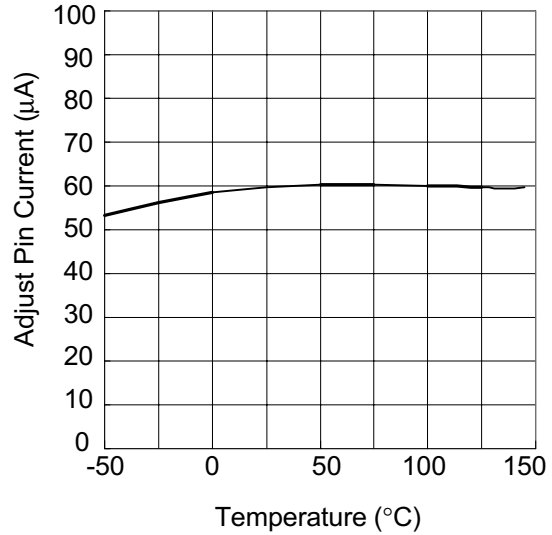

Ripple Rejection vs Frequency

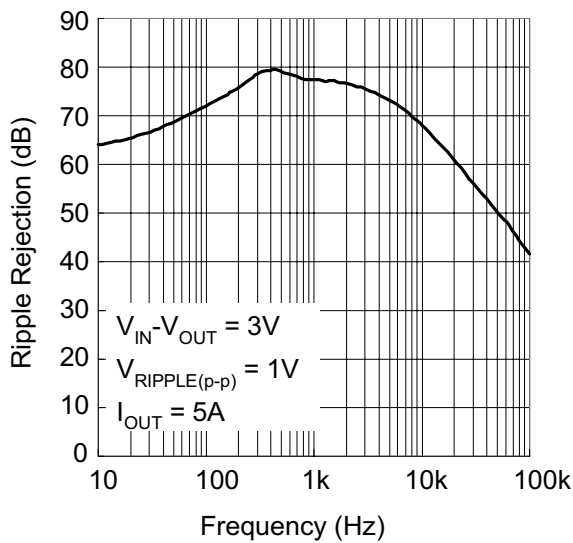

Maximum Power Dissipation\*

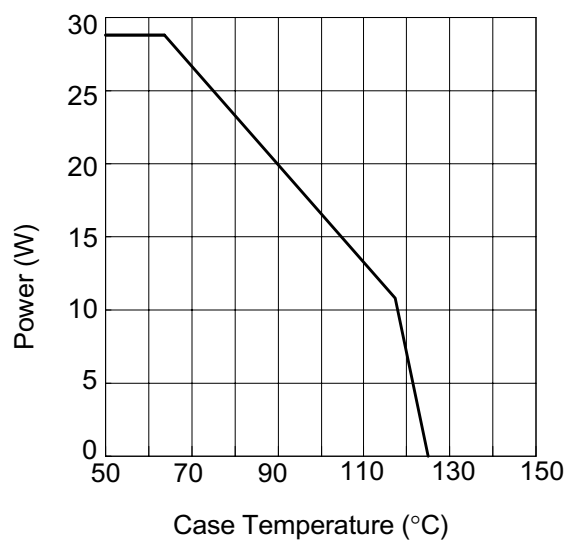

\* as Limited by Maximum Jcnction Temperature

Package Informaion

TO-252( Reference JEDEC Registration TO-252)

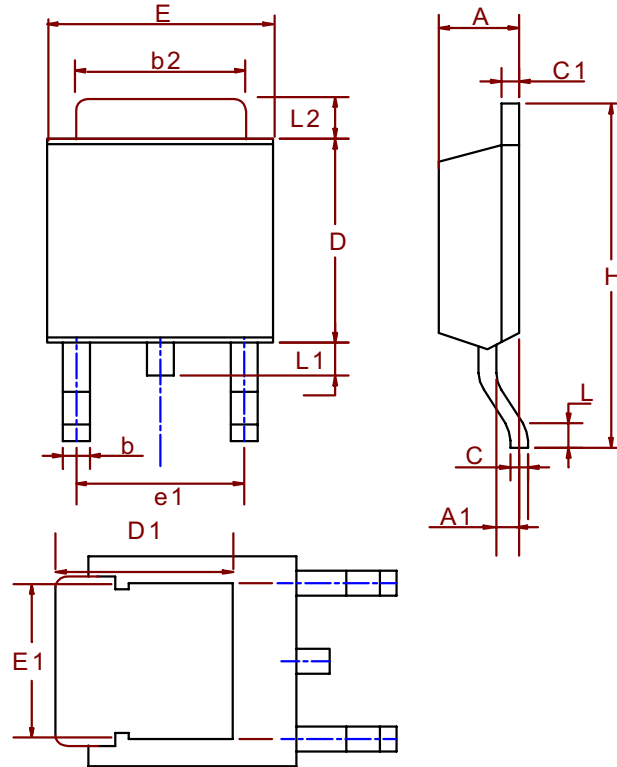

Dim	Millimeters		Inches	
	Min.	Max.	Min.	Max.
A	2.18	2.39	0.086	0.094
A1	0.89	1.27	0.035	0.050
b	0.508	0.89	0.020	0.035
b2	5.207	5.461	0.205	0.215
C	0.46	0.58	0.018	0.023
C1	0.46	0.58	0.018	0.023
D	5.334	6.22	0.210	0.245
D1	5.2 REF		0.205 REF	
E	6.35	6.73	0.250	0.265
E1	5.3 REF		0.209 REF	
e1	3.96	5.18	0.156	0.204
H	9.398	10.41	0.370	0.410
L	0.51		0.020	
L1	0.64	1.02	0.025	0.040
L2	0.89	2.032	0.035	0.080

# Package Informaion

TO-263 ( Reference JEDEC Registration TO-263)

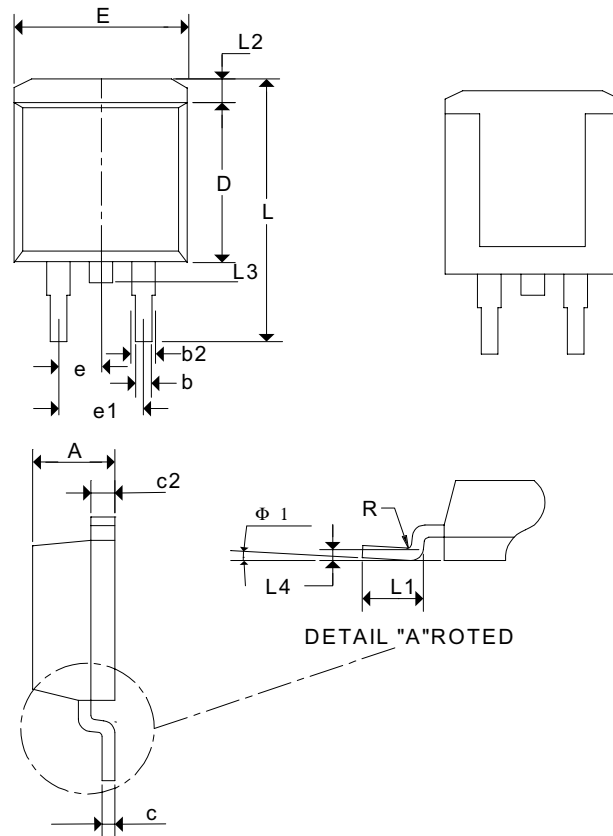

Dim	Millimeters		Inches	
	Min.	Max.	Min.	Max.
A	4.06	4.83	0.160	0.190
b	0.51	1.016	0.02	0.040
b2	1.14	1.651	0.045	0.065
c	0.38 TYP.		0.015 TYP.	
c2	1.14	1.40	0.045	0.055
D	8.64	9.65	0.340	0.380
e	2.54 TYP		0.100 TYP	
e1	4.83	5.33	0.190	0.210
L	14.60	15.88	0.575	0.625
L1	2.24	2.84	0.090	0.110
L2	1.02	2.92	0.040	0.112
L3	1.20	1.78	0.050	0.070

## Package Information

TO-220 (Reference JEDEC Registration TO-220)

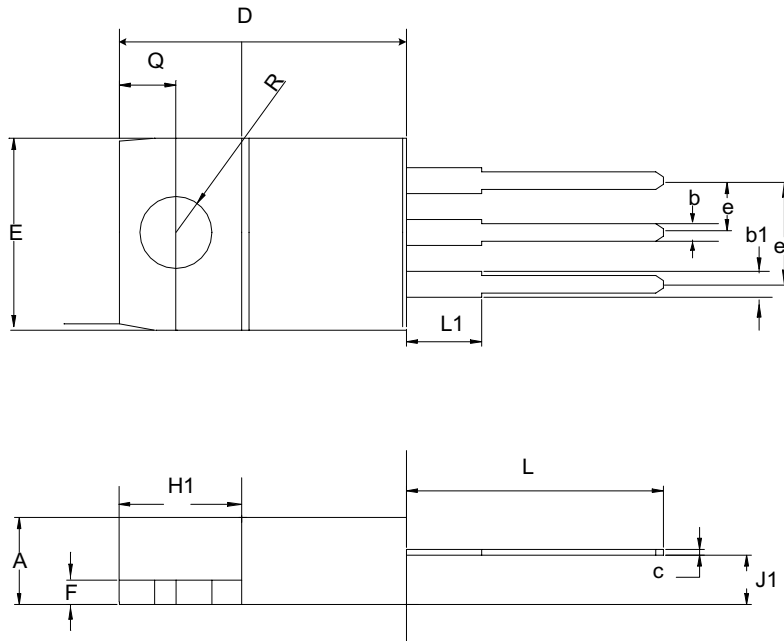

Dim	Millimeters		Inches	
	Min.	Max.	Min.	Max.
A	3.56	4.83	0.140	0.190
b1	1.14	1.78	0.045	0.070
b	0.51	1.14	0.020	0.045
c	0.31	1.14	0.012	0.045
D	14.23	16.51	0.560	0.650
e	2.29	2.79	0.090	0.110
e1	4.83	5.33	0.190	0.210
E	9.65	10.67	0.380	0.420
F	0.51	1.40	0.020	0.055
H1	5.84	6.86	0.230	0.270
J1	2.03	2.92	0.080	0.115
L	12.7	14.73	0.500	0.580
L1	3.65	6.35	0.143	0.250
R	3.53	4.09	0.139	0.161
Q	2.54	3.43	0.100	0.135



# Package Information

TO-264

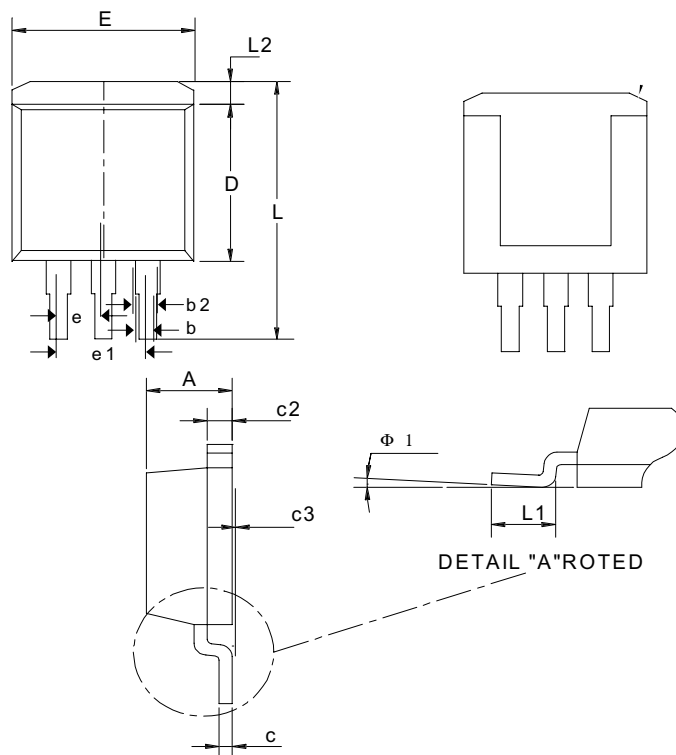

Dim	Millimeters		Inches	
	Min.	Max.	Min.	Max.
A	4.06	4.83	0.160	0.190
b	0.51	1.016	0.02	0.040
b2	1.14	1.651	0.045	0.065
c	0.38 TYP.		0.015 TYP.	
c2	1.14	1.40	0.045	0.055
c3	0	0.102	0	0.004
D	8.64	9.65	0.340	0.380
e	2.54 TYP		0.100 TYP	
e1	4.83	5.33	0.190	0.210
E	9.65	10.54	0.380	0.415
L	14.60	15.88	0.575	0.625
L1	2.24	2.84	0.090	0.110
L2	1.02	2.92	0.040	0.112
Φ1	0°	8°	0°	8°

## Physical Specifications

Terminal Material	Solder-Plated Copper (Solder Material : 90/10 or 63/37 SnPb)
Lead Solderability	Meets EIA Specification RSI86-91, ANSI/J-STD-002 Category 3.

## Reflow Condition (IR/Convection or VPR Reflow)

Reference JEDEC Standard J-STD-020A APRIL 1999

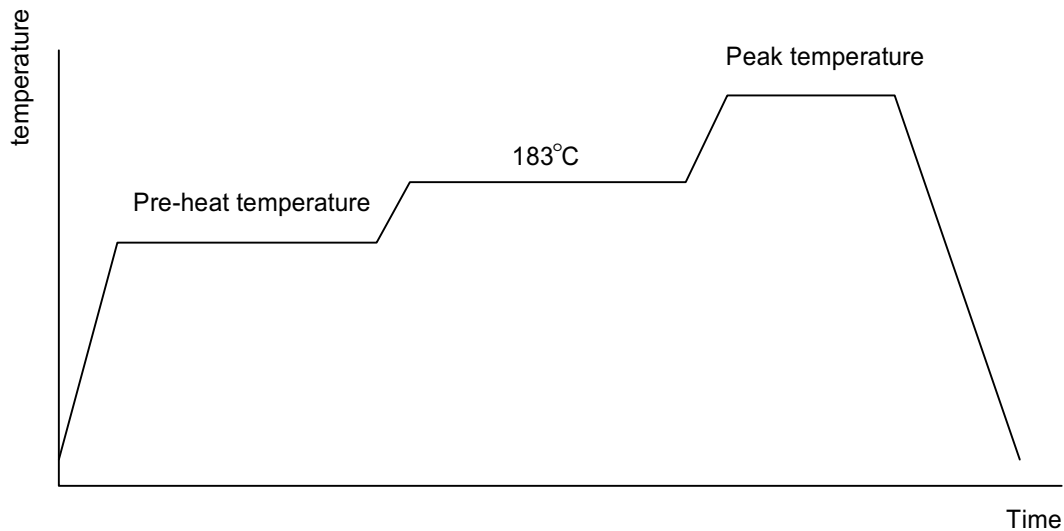

## Classification Reflow Profiles

	Convection or IR/ Convection	VI
Average ramp-up rate(183°C to Peak)	3°C/second max.	10 °C /second max.
Preheat temperature 125 ± 25°C)	120 seconds max	
Temperature maintained above 183°C	60 – 150 seconds	
Time within 5°C of actual peak temperature	10 –20 seconds	60 seconds
Peak temperature range	220 +5/-0°C or 235 +5/-0°C	215-219°C or 235 +5/-0°C
Ramp-down rate	6 °C /second max.	10 °C /second max.
Time 25°C to peak temperature	6 minutes max.	

## Package Reflow Conditions

pkg. thickness ≥ 2.5mm and all bgas	pkg. thickness < 2.5mm and pkg. volume ≥ 350 mm <sup>3</sup>	pkg. thickness < 2.5mm and pkg. volume < 350mm <sup>3</sup>
Convection 220 +5/-0 °C		Convection 235 +5/-0 °C
VPR 215-219 °C		VPR 235 +5/-0 °C
IR/Convection 220 +5/-0 °C		IR/Convection 235 +5/-0 °C

### Reliability test program

Test item	Method	Description
SOLDERABILITY	MIL-STD-883D-2003	245°C , 5 SEC
HOLT	MIL-STD-883D-1005.7	1000 Hrs Bias @ 125 °C
PCT	JESD-22-B, A102	168 Hrs, 100 % RH , 121°C
TST	MIL-STD-883D-1011.9	-65°C ~ 150°C, 200 Cycles
ESD	MIL-STD-883D-3015.7	VHBM > 2KV, VMM > 200V
Latch-Up	JESD 78	10ms , I <sub>tr</sub> > 100mA

### Carrier Tape

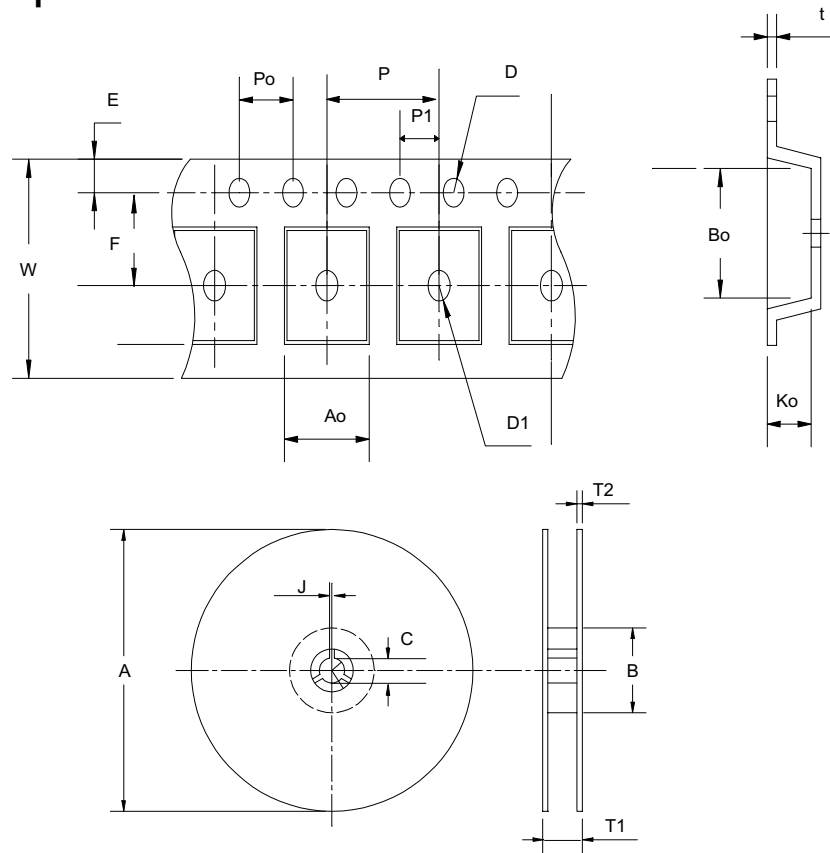

Application	A	B	C	J	T1	T2	W	P	E
TO-252	330±3	100±2	13±0.5	2±0.5	16.4 +0.3 -0.2	2.5±0.5	16 +0.3 -0.1	8±0.1	1.75±0.1
	F	D	D1	Po	P1	Ao	Bo	Ko	t
	7.5±0.1	1.5+0.1	1.5±0.25	4.0±0.1	2.0±0.1	6.8±0.1	10.4±0.1	2.5±0.1	0.3±0.05
Application	A	B	C	J	T1	T2	W	P	E
TO-263	380±3	80±2	13±0.5	2±0.5	24±4	2±0.3	24 +0.3 -0.1	16±0.1	1.75±0.1
	F	D	D1	Po	P1	Ao	Bo	Ko	t
	11.5±0.1	1.5+0.1	1.5±0.25	4.0±0.1	2.0±0.1	10.8±0.1	16.1±0.1	5.2±0.1	0.35±0.013

## Cover Tape Dimensions

Application	Carrier Width	Cover Tape Width	Devices Per Reel
TO- 252	16	13.3	2500
TO- 263	24	21.3	1000

## Customer Service

### Anpec Electronics Corp.

Head Office :

5F, No. 2 Li-Hsin Road, SBIP,  
Hsin-Chu, Taiwan, R.O.C.  
Tel : 886-3-5642000  
Fax : 886-3-5642050

Taipei Branch :

7F, No. 137, Lane 235, Pac Chiao Rd.,  
Hsin Tien City, Taipei Hsien, Taiwan, R. O. C.  
Tel : 886-2-89191368  
Fax : 886-2-89191369