



Features

- 30A Peak Source/Sink Drive Current
- High Operating Voltage Capability: 35V
- -40°C to +125°C Extended Operating Temperature Range
- Under-Voltage Lockout Protection
- Logic Input Withstands Negative Swing of up to 5V
- Fast Rise and Fall Times: < 20ns
- Low Propagation Delay Time
- Low 10 μ A Supply Current
- Low Output Impedance

Applications

- Efficient Power MOSFET and IGBT Switching
- Switch Mode Power Supplies
- Motor Controls
- DC to DC Converters
- Class-D Switching Amplifiers
- Pulse Transformer Driver



Description

The IXDD630/IXDI630/IXDN630 high-speed gate drivers are especially well suited for driving the latest IXYS power MOSFETs and IGBTs. The IXD_630 output can source and sink 30A of peak current while producing voltage rise and fall times of less than 20ns. Internal circuitry eliminates cross conduction and current "shoot-through," and the driver is virtually immune to latch up. Under-voltage lockout (UVLO) circuitry holds the output LOW until sufficient supply voltage is applied (12.5V for the IXD_630 versions, and 9V for the IXD_630M versions). Low propagation delays and fast, matched rise and fall times make the IXD_630 family ideal for very high frequency and high-power applications.

The IXDD630 is configured as a non-inverting driver with an enable. The IXDN630 is configured as a non-inverting driver, and the IXDI630 is configured as an inverting driver.

The IXD_630 family is available in a 5-pin TO-220 (CI), and a 5-pin TO-263 (YI) package.

Ordering Information

| Part Number | Logic Configuration | UVLO | Package Type | Packing Method | Quantity |
|-------------|---------------------|-------|--------------|----------------|----------|
| IXDD630CI | | 12.5V | 5-Pin TO-220 | Tube | 50 |
| IXDD630MCI | | 9V | 5-Pin TO-220 | Tube | 50 |
| IXDD630YI | | 12.5V | 5-Pin TO-263 | Tube | 50 |
| IXDD630MYI | | 9V | 5-Pin TO-263 | Tube | 50 |
| IXDI630CI | | 12.5V | 5-Pin TO-220 | Tube | 50 |
| IXDI630MCI | | 9V | 5-Pin TO-220 | Tube | 50 |
| IXDI630YI | | 12.5V | 5-Pin TO-263 | Tube | 50 |
| IXDI630MYI | | 9V | 5-Pin TO-263 | Tube | 50 |
| IXDN630CI | | 12.5V | 5-Pin TO-220 | Tube | 50 |
| IXDN630MCI | | 9V | 5-Pin TO-220 | Tube | 50 |
| IXDN630YI | | 12.5V | 5-Pin TO-263 | Tube | 50 |
| IXDN630MYI | | 9V | 5-Pin TO-263 | Tube | 50 |

| | |
|---|-----------|
| 1. Specifications | 3 |
| 1.1 Lead Configurations | 3 |
| 1.2 Lead Definitions | 3 |
| 1.3 Absolute Maximum Ratings | 3 |
| 1.4 Recommended Operating Conditions | 4 |
| 1.5 Electrical Characteristics: $T_A = 25^\circ\text{C}$ | 4 |
| 1.6 Electrical Characteristics: $T_A = -40^\circ\text{C}$ to $+125^\circ\text{C}$ | 5 |
| 1.7 Thermal Characteristics | 5 |
| 2. Functional Description | 6 |
| 2.1 IXDD630 Block Diagram & Truth Table | 6 |
| 2.2 IXDI630 Block Diagram & Truth Table | 6 |
| 2.3 IXDN630 Block Diagram & Truth Table | 6 |
| 3. Typical Performance Characteristics | 7 |
| 4. Manufacturing Information | 10 |
| 4.1 Moisture Sensitivity | 10 |
| 4.2 ESD Sensitivity | 10 |
| 4.3 Reflow Profile | 10 |
| 4.4 Board Wash | 10 |
| 4.5 Mechanical Dimensions | 11 |

1 Specifications

1.1 Lead Configurations

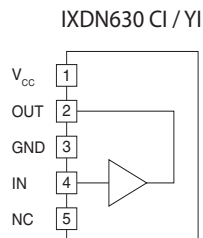
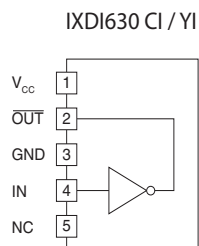
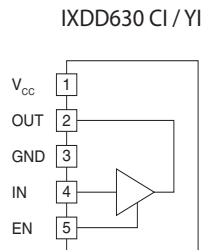

1.2 Lead Definitions

| Lead Name | Description |
|-------------------------|--|
| IN | Logic Input |
| EN | Output Enable - Drive lead low to disable output, and force output to a high impedance state |
| OUT | Output - Sources or sinks current to turn-on or turn-off a discrete MOSFET or IGBT |
| $\overline{\text{OUT}}$ | Inverted Output - Sources or sinks current to turn-on or turn-off a discrete MOSFET or IGBT |
| V_{CC} | Supply Voltage - Provides power to the device |
| GND | Ground - Common ground reference for the device |
| NC | Not connected |

1.3 Absolute Maximum Ratings

| Parameter | Symbol | Minimum | Maximum | Units |
|----------------------|------------------|---------|--------------|--------------------|
| Supply Voltage | V_{CC} | -0.3 | 40 | V |
| Input Voltage Range | V_{IN}, V_{EN} | -5 | $V_{CC}+0.3$ | V |
| Output Current | I_{OUT} | - | ± 30 | A |
| Junction Temperature | T_J | -55 | +150 | $^{\circ}\text{C}$ |
| Storage Temperature | T_{STG} | -65 | +150 | $^{\circ}\text{C}$ |

Unless stated otherwise, absolute maximum electrical ratings are at 25°C

Absolute maximum ratings are stress ratings. Stresses in excess of these ratings can cause permanent damage to the device. Functional operation of the device at conditions beyond those indicated in the operational sections of this data sheet is not implied.

1.4 Recommended Operating Conditions

| Parameter | Symbol | Minimum | Maximum | Units |
|-----------------------------|----------|---------|---------|-------|
| Supply Voltage | V_{CC} | UVLO | 35 | V |
| Operating Temperature Range | T_A | -40 | +125 | °C |

1.5 Electrical Characteristics: $T_A = 25^\circ\text{C}$

Test Conditions: $UVLO \leq V_{CC} \leq 35\text{V}$ (unless otherwise noted).

| Parameter | Conditions | Symbol | Minimum | Typical | Maximum | Units |
|----------------------------------|--|--------------------|----------------|---------|-------------|---------------|
| Input Voltage, High | $UVLO \leq V_{CC} \leq 18\text{V}$ | V_{IH} | 3.5 | - | - | V |
| Input Voltage, Low | $UVLO \leq V_{CC} \leq 18\text{V}$ | V_{IL} | - | - | 0.8 | |
| Input Current | $0\text{V} \leq V_{IN} \leq V_{CC}$ | I_{IN} | - | - | ± 10 | μA |
| EN Input Voltage, High | IXDD630 only | V_{ENH} | $2/3V_{CC}$ | - | - | V |
| EN Input Voltage, Low | IXDD630 only | V_{ENL} | - | - | $1/3V_{CC}$ | |
| Output Voltage, High | - | V_{OH} | $V_{CC}-0.025$ | - | - | V |
| Output Voltage, Low | - | V_{OL} | - | - | 0.025 | |
| Output Resistance, High State | $V_{CC}=18\text{V}, I_{OUT}=-100\text{mA}$ | R_{OH} | - | 0.17 | 0.4 | Ω |
| Output Resistance, Low State | $V_{CC}=18\text{V}, I_{OUT}=100\text{mA}$ | R_{OL} | - | 0.16 | 0.3 | |
| Output Current, Continuous | Limited by package power dissipation | I_{DC} | - | - | ± 8 | A |
| Rise Time | $C_{LOAD}=5.6\text{nF}, V_{CC}=18\text{V}$ | t_r | - | 11 | 20 | ns |
| Fall Time | $C_{LOAD}=5.6\text{nF}, V_{CC}=18\text{V}$ | t_f | - | 11 | 18 | |
| On-Time Propagation Delay | $C_{LOAD}=5.6\text{nF}, V_{CC}=18\text{V}$ | t_{ondly} | - | 46 | 65 | |
| Off-Time Propagation Delay | $C_{LOAD}=5.6\text{nF}, V_{CC}=18\text{V}$ | t_{offdly} | - | 46 | 65 | |
| Output Enable Time | IXDD630 only | t_{PZL}, t_{PZH} | - | 34 | 65 | |
| Output Disable Time | IXDD630 only | t_{PLZ}, t_{PHZ} | - | 65 | 125 | |
| Enable Pull-Up Resistor | IXDD630 only | R_{EN} | - | 400 | - | $k\Omega$ |
| Power Supply Current | $V_{CC}=18\text{V}, V_{IN}=3.5\text{V}$ | I_{CC} | - | 2.5 | 4 | mA |
| | $V_{CC}=18\text{V}, V_{IN}=0\text{V}$ | | - | - | 0.75 | |
| | $V_{CC}=18\text{V}, V_{IN}=V_{CC}$ | | - | - | 0.75 | |
| Under-Voltage Lockout Threshold | V_{CC} Rising, IXD_630M | UVLO | 7 | 9 | 9.9 | V |
| | V_{CC} Rising, IXD_630 | | 10 | 12.5 | 13.5 | |
| Under-Voltage Lockout Hysteresis | IXD_630M | - | - | 1 | - | V |
| | IXD_630 | | - | 1.5 | - | |

1.6 Electrical Characteristics: $T_A = -40^{\circ}\text{C}$ to $+125^{\circ}\text{C}$

Test Conditions: $UVLO \leq V_{CC} \leq 35\text{V}$, $T_J < 150^{\circ}\text{C}$.

| Parameter | Conditions | Symbol | Minimum | Maximum | Units |
|-------------------------------|---|--------------|---------|---------|----------|
| Input Voltage, High | $UVLO \leq V_{CC} \leq 18\text{V}$ | V_{IH} | 4 | - | V |
| Input Voltage, Low | $UVLO \leq V_{CC} \leq 18\text{V}$ | V_{IL} | - | 0.8 | |
| Output Resistance, High State | $V_{CC}=18\text{V}$, $I_{OUT} = -100\text{mA}$ | R_{OH} | - | 0.6 | Ω |
| Output Resistance, Low State | $V_{CC}=18\text{V}$, $I_{OUT}=100\text{mA}$ | R_{OL} | - | 0.45 | |
| Rise Time | $C_{LOAD}=5.6\text{nF}$, $V_{CC}=18\text{V}$ | t_r | - | 35 | ns |
| Fall Time | $C_{LOAD}=5.6\text{nF}$, $V_{CC}=18\text{V}$ | t_f | - | 35 | |
| On-Time Propagation Delay | $C_{LOAD}=5.6\text{nF}$, $V_{CC}=18\text{V}$ | t_{ondly} | - | 100 | |
| Off-Time Propagation Delay | $C_{LOAD}=5.6\text{nF}$, $V_{CC}=18\text{V}$ | t_{offdly} | - | 100 | |

1.7 Thermal Characteristics

| Package | Parameter | Symbol | Rating | Units |
|---------------------------|---|---------------|--------|-----------------------------|
| IXD_630CI (5-Lead TO-220) | Thermal Resistance, Junction-to-Ambient | θ_{JA} | 36 | $^{\circ}\text{C}/\text{W}$ |
| IXD_630YI (5-Lead TO-263) | | | 46 | |
| IXD_630CI (5-Lead TO-220) | Thermal Resistance, Junction-to-Case | θ_{JC} | 3 | $^{\circ}\text{C}/\text{W}$ |
| IXD_630YI (5-Lead TO-263) | | | 2 | |

2 Functional Description

2.1 IXDD630 Block Diagram & Truth Table

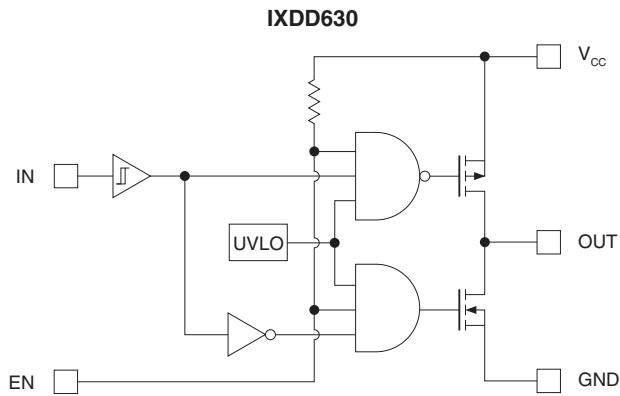

| IN | EN | OUT |
|----|-----------|-----|
| 0 | 1 or open | 0 |
| 1 | 1 or open | 1 |
| 0 | 0 | Z |
| 1 | 0 | Z |

2.3 IXDN630 Block Diagram & Truth Table

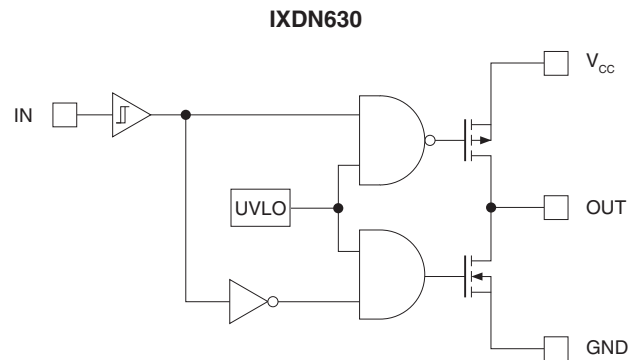

| IN | OUT |
|----|-----|
| 0 | 0 |
| 1 | 1 |

2.2 IXDI630 Block Diagram & Truth Table

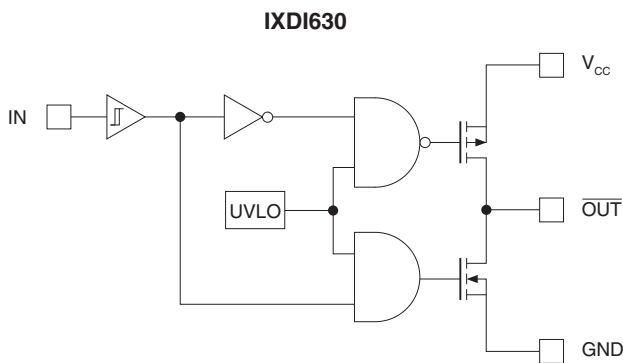

| IN | OUT |
|----|-----|
| 0 | 1 |
| 1 | 0 |

3 Typical Performance Characteristics

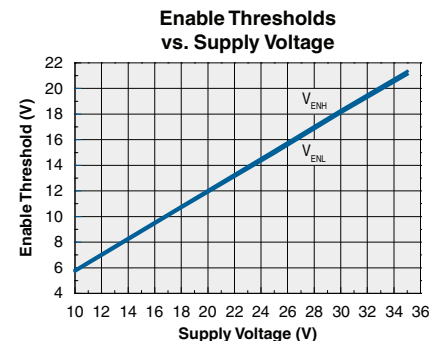
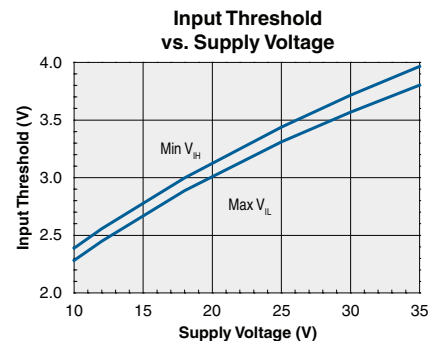
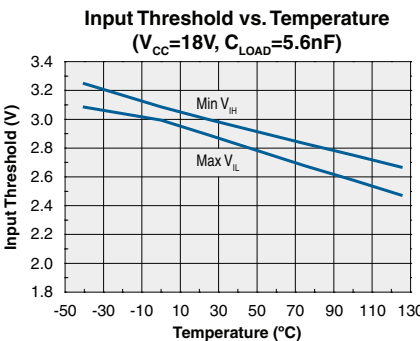
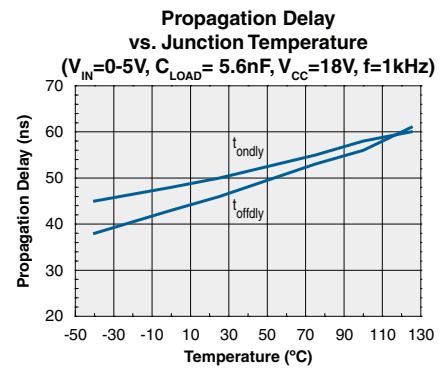
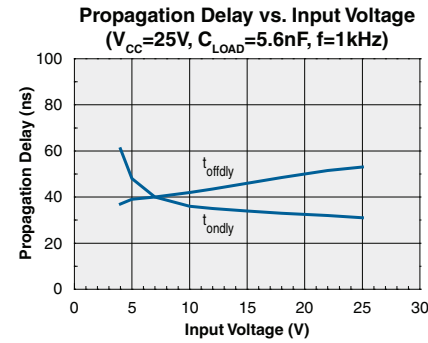
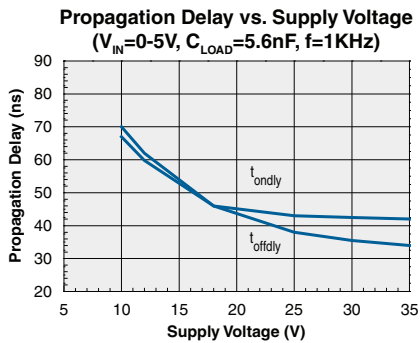
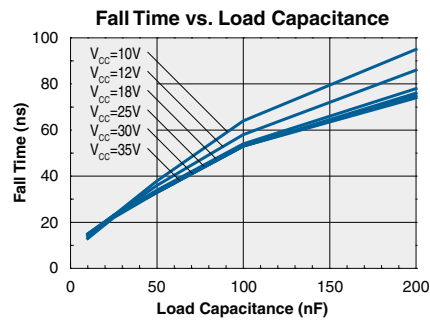
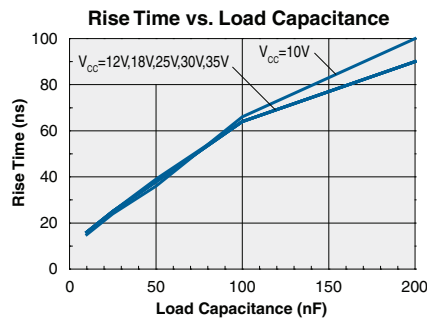
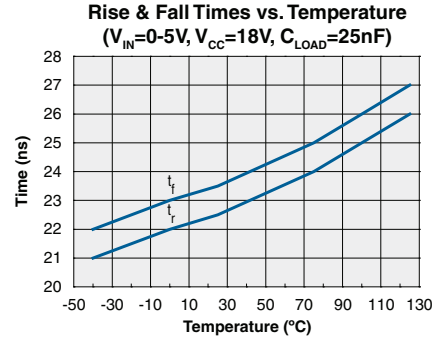
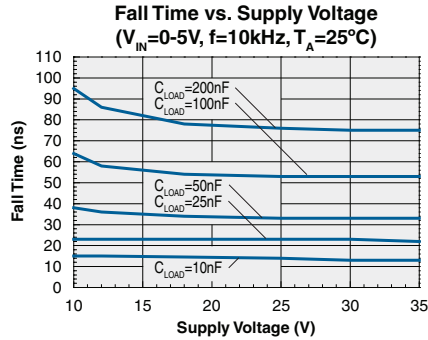
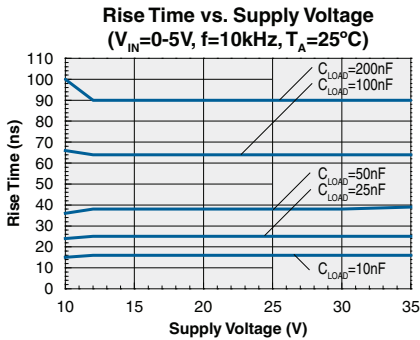

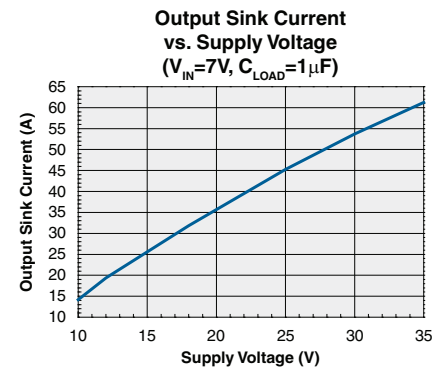
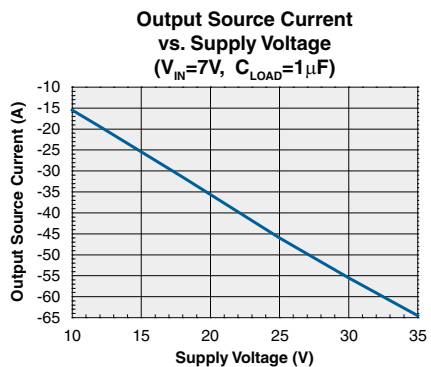
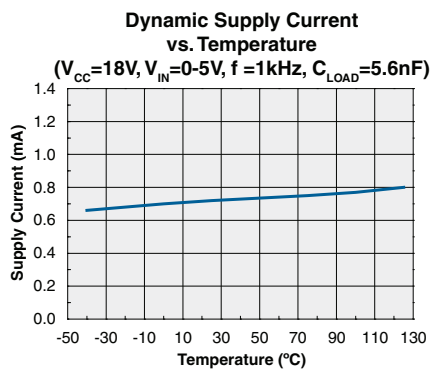
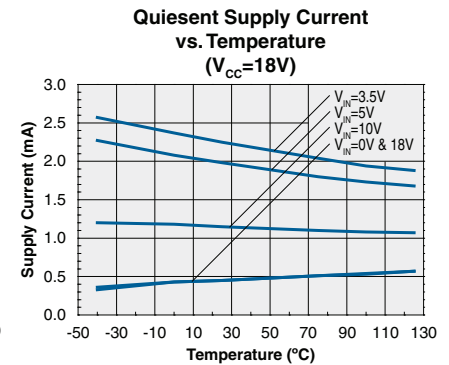
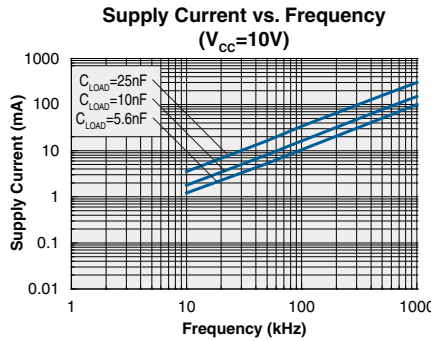
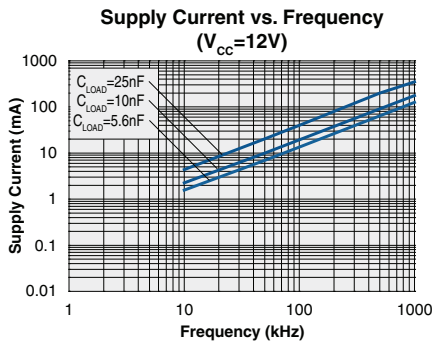
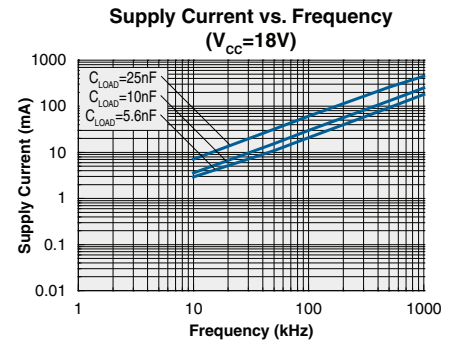
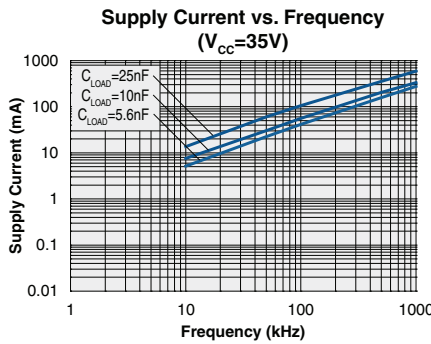
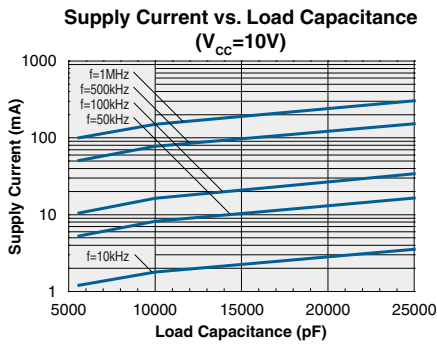
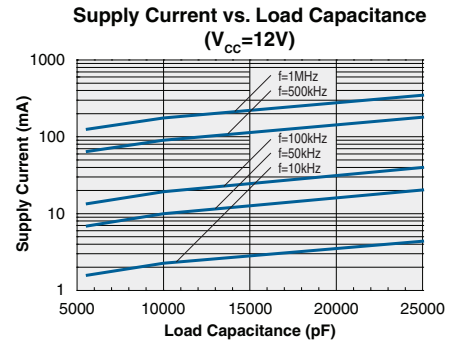
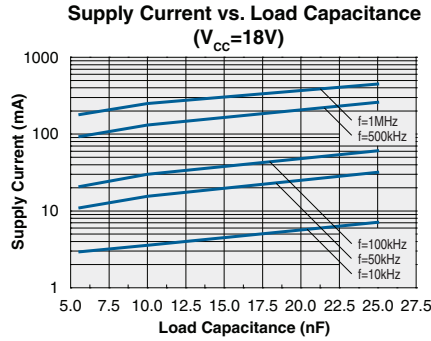
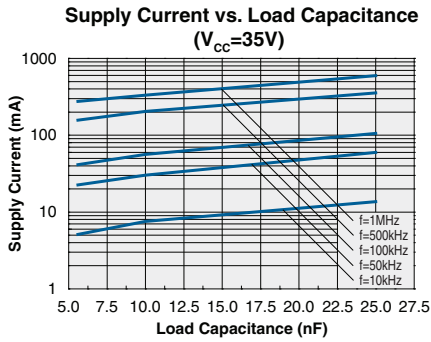

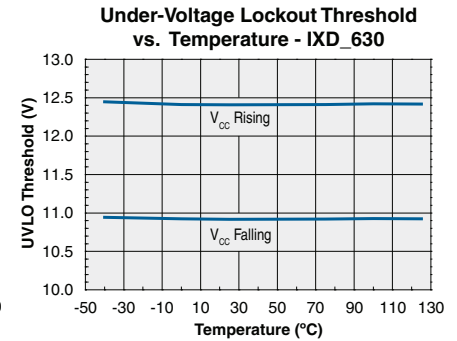
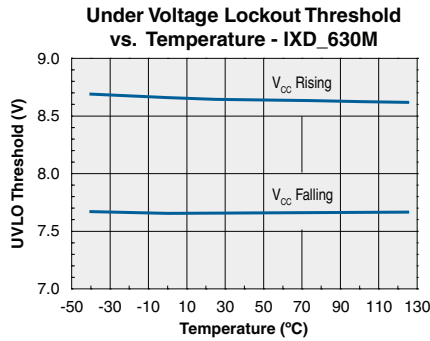
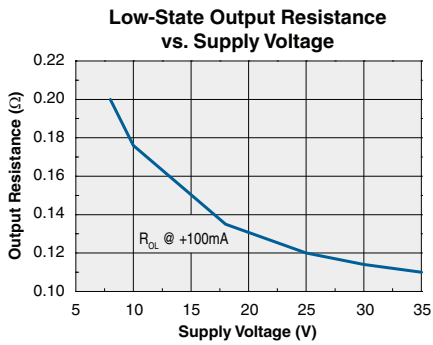
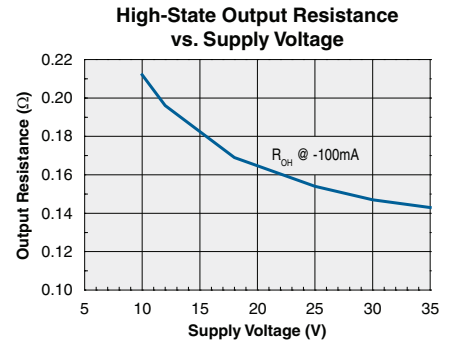
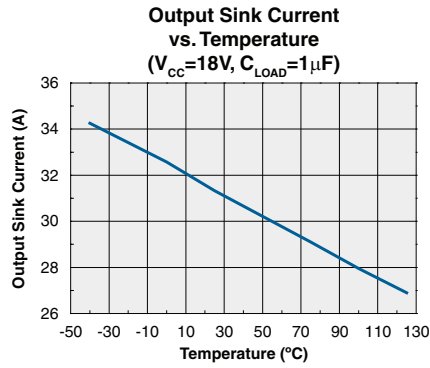
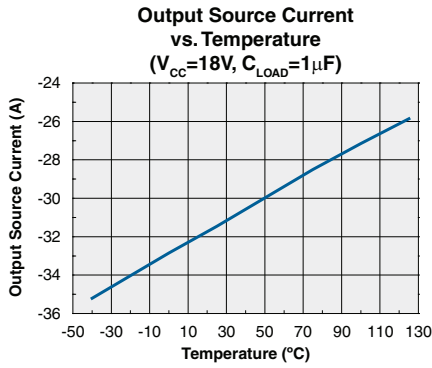

4 Manufacturing Information

4.1 Moisture Sensitivity



All plastic encapsulated semiconductor packages are susceptible to moisture ingress. Clare classified all of its plastic encapsulated devices for moisture sensitivity according to the latest version of the joint industry standard, **IPC/JEDEC J-STD-020**, in force at the time of product evaluation. We test all of our products to the maximum conditions set forth in the standard, and guarantee proper operation of our devices when handled according to the limitations and information in that standard as well as to any limitations set forth in the information or standards referenced below.

Failure to adhere to the warnings or limitations as established by the listed specifications could result in reduced product performance, reduction of operable life, and/or reduction of overall reliability.

This product carries a **Moisture Sensitivity Level (MSL) rating** as shown below, and should be handled according to the requirements of the latest version of the joint industry standard **IPC/JEDEC J-STD-033**.

| Device | Moisture Sensitivity Level (MSL) Rating |
|---|---|
| IXD_630Y1 / IXD_630MY1 / IXD_630C1 / IXD_630MCI | MSL1 |

4.2 ESD Sensitivity



This product is **ESD Sensitive**, and should be handled according to the industry standard **JESD-625**.

4.3 Reflow Profile

This product has a maximum body temperature and time rating as shown below. All other guidelines of **J-STD-020** must be observed.

| Device | Maximum Temperature x Time |
|---|----------------------------|
| IXD_630Y1 / IXD_630MY1 / IXD_630C1 / IXD_630MCI | 245°C for 30 seconds |

4.4 Board Wash

Clare recommends the use of no-clean flux formulations. However, board washing to remove flux residue is acceptable, and the use of a short drying bake may be necessary. Chlorine-based or Fluorine-based solvents or fluxes should not be used. Cleaning methods that employ ultrasonic energy should not be used.



4.5 Mechanical Dimensions

4.5.1 IXD_630YI (5-Lead TO-263)

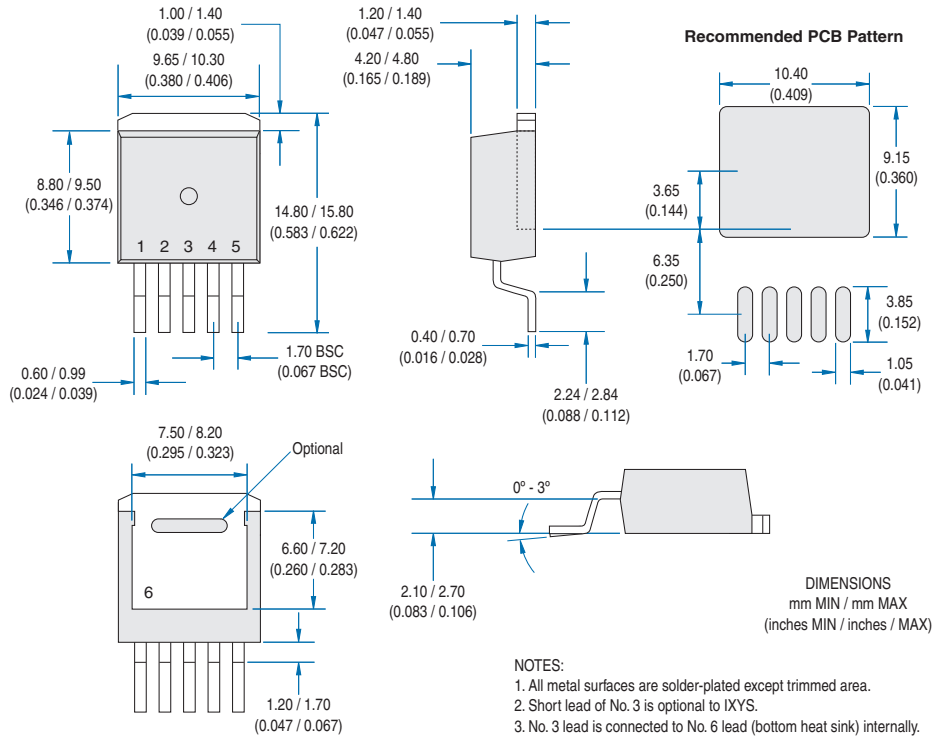

4.5.2 IXD_630CI (5-Lead TO-220)

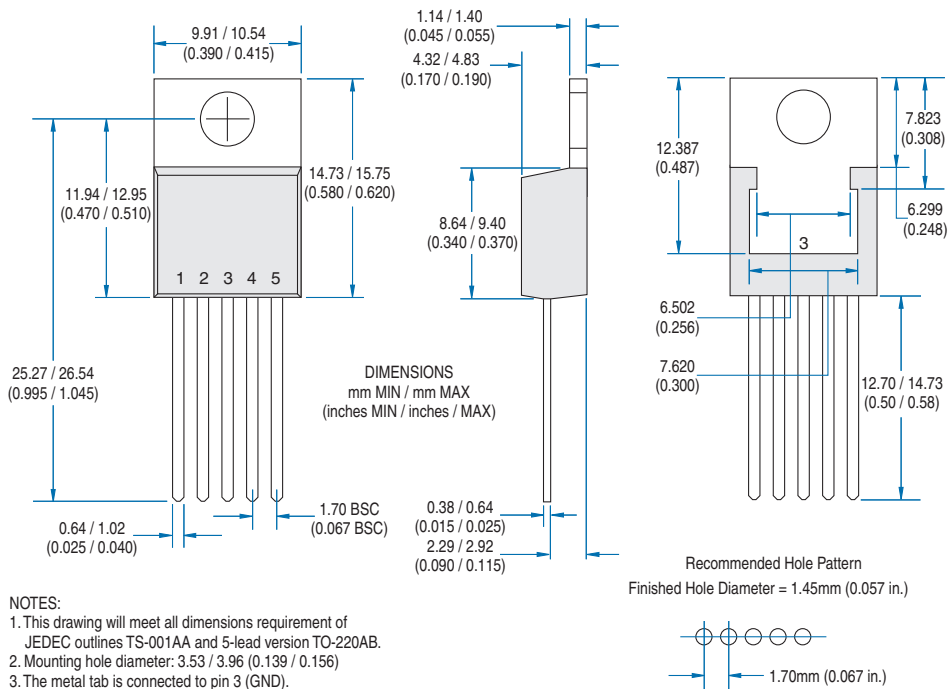

For additional information please visit our website at: www.clare.com

Clare, Inc. makes no representations or warranties with respect to the accuracy or completeness of the contents of this publication and reserves the right to make changes to specifications and product descriptions at any time without notice. Neither circuit patent licenses nor indemnity are expressed or implied. Except as set forth in Clare's Standard Terms and Conditions of Sale, Clare, Inc. assumes no liability whatsoever, and disclaims any express or implied warranty, relating to its products including, but not limited to, the implied warranty of merchantability, fitness for a particular purpose, or infringement of any intellectual property right.

The products described in this document are not designed, intended, authorized or warranted for use as components in systems intended for surgical implant into the body, or in other applications intended to support or sustain life, or where malfunction of Clare's product may result in direct physical harm, injury, or death to a person or severe property or environmental damage. Clare, Inc. reserves the right to discontinue or make changes to its products at any time without notice.

Specification: DS-IXD_630-R01
©Copyright 2011, Clare, Inc.
All rights reserved. Printed in USA.
9/29/2011