



## Features

- 9A Peak Source/Sink Drive Current
- Wide Operating Voltage Range: 4.5V to 35V
- -40°C to +125°C Extended Operating Temperature Range
- Logic Input Withstands Negative Swing of up to 5V
- Matched Rise and Fall Times
- Low Propagation Delay Time
- Low, 10µA Supply Current
- Low Output Impedance

## Applications

- Efficient Power MOSFET and IGBT Switching
- Switch Mode Power Supplies
- Motor Controls
- DC to DC Converters
- Class-D Switching Amplifiers
- Pulse Transformer Driver



## Description

The IXDD609/IXDI609/IXDN609 high-speed gate drivers are especially well suited for driving the latest IXYS MOSFETs and IGBTs. The IXD\_609 high-current output can source and sink 9A of peak current while producing voltage rise and fall times of less than 25ns. The input is CMOS compatible, and is virtually immune to latch up. Proprietary circuitry eliminates cross-conduction and current “shoot-through.” Low propagation delay and fast, matched rise and fall times make the IXD\_609 family ideal for high-frequency and high-power applications.

The IXDD609 is configured as a non-inverting driver with an enable, the IXDN609 is configured as a non-inverting driver, and the IXDI609 is configured as an inverting driver.

The IXD\_609 family is available in a standard 8-pin DIP (PI); an 8-pin SOIC (SIA); an 8-pin Power SOIC with an exposed metal back (SI); an 8-pin DFN (D2); a 5-pin TO-263 (YI); and a 5-pin TO-220 (CI).

## Ordering Information

Part Number	Logic Configuration	Package Type	Packing Method	Quantity
IXDD609D2TR		8-Pin DFN	Tape & Reel	2000
IXDD609SI		8-Pin Power SOIC with Exposed Metal Back	Tube	100
IXDD609SITR		8-Pin Power SOIC with Exposed Metal Back	Tape & Reel	2000
IXDD609SIA		8-Pin SOIC	Tube	100
IXDD609SIATR		8-Pin SOIC	Tape & Reel	2000
IXDD609PI		8-Pin DIP	Tube	50
IXDD609CI		5-Pin TO-220	Tube	50
IXDD609YI		5-Pin TO-263	Tube	50
IXDI609SI		8-Pin Power SOIC with Exposed Metal Back	Tube	100
IXDI609SITR		8-Pin Power SOIC with Exposed Metal Back	Tape & Reel	2000
IXDI609SIA		8-Pin SOIC	Tube	100
IXDI609SIATR		8-Pin SOIC	Tape & Reel	2000
IXDI609PI		8-Pin DIP	Tube	50
IXDI609CI		5-Pin TO-220	Tube	50
IXDI609YI		5-Pin TO-263	Tube	50
IXDN609SI		8-Pin Power SOIC with Exposed Metal Back	Tube	100
IXDN609SITR		8-Pin Power SOIC with Exposed Metal Back	Tape & Reel	2000
IXDN609SIA		8-Pin SOIC	Tube	100
IXDN609SIATR		8-Pin SOIC	Tape & Reel	2000
IXDN609PI		8-Pin DIP	Tube	50
IXDN609CI		5-Pin TO-220	Tube	50
IXDN609YI		5-Pin TO-263	Tube	50

<b>1. Specifications</b> .....	<b>3</b>
1.1 Pin Configurations .....	3
1.2 Pin Definitions .....	3
1.3 Absolute Maximum Ratings .....	3
1.4 Recommended Operating Conditions .....	3
1.5 Electrical Characteristics: $T_A = 25^\circ\text{C}$ .....	4
1.6 Electrical Characteristics: $T_A = -40^\circ\text{C}$ to $+125^\circ\text{C}$ .....	4
1.7 Thermal Characteristics .....	5
<b>2. IXD_609 Performance</b> .....	<b>5</b>
2.1 Timing Diagrams .....	5
2.2 Characteristics Test Diagram .....	5
<b>3. Block Diagrams &amp; Truth Tables</b> .....	<b>6</b>
3.1 IXDD609 .....	6
3.2 IXDI609 .....	6
3.3 IXDN609 .....	6
<b>4. Typical Performance Characteristics</b> .....	<b>7</b>
<b>5. Manufacturing Information</b> .....	<b>10</b>
5.1 Moisture Sensitivity .....	10
5.2 ESD Sensitivity .....	10
5.3 Reflow Profile .....	10
5.4 Mechanical Dimensions .....	11

## 1 Specifications

### 1.1 Pin Configurations

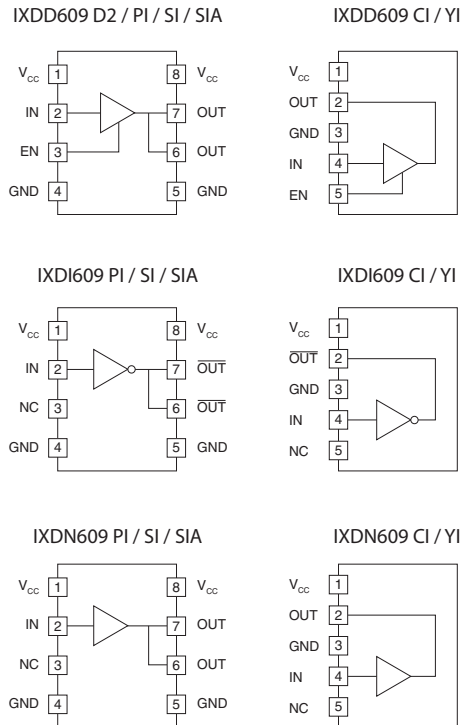

### 1.2 Pin Definitions

Pin Name	Description
IN	Logic Input
EN	Output Enable - Drive pin low to disable output, and force output to a high impedance state
OUT	Output - Sources or sinks current to turn-on or turn-off a discrete MOSFET or IGBT
$\overline{\text{OUT}}$	Inverted Output - Sources or sinks current to turn-on or turn-off a discrete MOSFET or IGBT
V <sub>CC</sub>	Supply Voltage - Provides power to the device
GND	Ground - Common ground reference for the device
NC	Not connected

### 1.3 Absolute Maximum Ratings

Parameter	Symbol	Minimum	Maximum	Units
Supply Voltage	V <sub>CC</sub>	-0.3	40	V
Input Voltage	V <sub>IN</sub> , V <sub>EN</sub>	-5	V <sub>CC</sub> +0.3	V
Output Current	I <sub>OUT</sub>	-	±9	A
Junction Temperature	T <sub>J</sub>	-55	+150	°C
Storage Temperature	T <sub>STG</sub>	-65	+150	°C

Unless stated otherwise, absolute maximum electrical ratings are at 25°C

*Absolute maximum ratings are stress ratings. Stresses in excess of these ratings can cause permanent damage to the device. Functional operation of the device at conditions beyond those indicated in the operational sections of this data sheet is not implied.*

### 1.4 Recommended Operating Conditions

Parameter	Symbol	Minimum	Maximum	Units
Supply Voltage	V <sub>CC</sub>	4.5	35	V
Operating Temperature Range	T <sub>A</sub>	-40	+125	°C

**1.5 Electrical Characteristics:  $T_A = 25^\circ\text{C}$** 

 Test Conditions:  $4.5\text{V} \leq V_{CC} \leq 35\text{V}$  (unless otherwise noted).

Parameter	Conditions	Symbol	Minimum	Typical	Maximum	Units
Input Voltage, High	$4.5\text{V} \leq V_{CC} \leq 18\text{V}$	$V_{IH}$	3.0	-	-	V
Input Voltage, Low	$4.5\text{V} \leq V_{CC} \leq 18\text{V}$	$V_{IL}$	-	-	0.8	
Input Current	$0\text{V} \leq V_{IN} \leq V_{CC}$	$I_{IN}$	-	-	$\pm 10$	$\mu\text{A}$
EN Input Voltage, High	IXDD609 only	$V_{ENH}$	$2/3V_{CC}$	-	-	V
EN Input Voltage, Low	IXDD609 only	$V_{ENL}$	-	-	$1/3V_{CC}$	
Output Voltage, High	-	$V_{OH}$	$V_{CC}-0.025$	-	-	V
Output Voltage, Low	-	$V_{OL}$	-	-	0.025	
Output Resistance, High State	$V_{CC}=18\text{V}, I_{OUT}=-100\text{mA}$	$R_{OH}$	-	0.6	1	$\Omega$
Output Resistance, Low State	$V_{CC}=18\text{V}, I_{OUT}=100\text{mA}$	$R_{OL}$	-	0.4	0.8	
Output Current, Continuous	Limited by package power dissipation	$I_{DC}$	-	-	$\pm 2$	A
Rise Time	$V_{CC}=18\text{V}, C_{LOAD}=10\text{nF}$	$t_r$	-	22	35	ns
Fall Time	$V_{CC}=18\text{V}, C_{LOAD}=10\text{nF}$	$t_f$	-	15	25	
On-Time Propagation Delay	$V_{CC}=18\text{V}, C_{LOAD}=10\text{nF}$	$t_{ondly}$	-	40	60	
Off-Time Propagation Delay	$V_{CC}=18\text{V}, C_{LOAD}=10\text{nF}$	$t_{offdly}$	-	42	60	
Enable to Output-High Delay Time (IXDD609 Only)	$V_{CC}=18\text{V}$	$t_{ENOH}$	-	25	60	
Disable to High Impedance State Delay Time (IXDD609 Only)	$V_{CC}=18\text{V}$	$t_{DOLD}$	-	35	60	
Enable Pull-Up Resistor	-	$R_{EN}$	-	200	-	$\text{k}\Omega$
Power Supply Current	$V_{CC}=18\text{V}, V_{IN}=3.5\text{V}$	$I_{CC}$	-	1	2	mA
	$V_{CC}=18\text{V}, V_{IN}=0\text{V}$		-	<1	10	
	$V_{CC}=18\text{V}, V_{IN}=V_{CC}$		-	<1	10	$\mu\text{A}$

**1.6 Electrical Characteristics:  $T_A = -40^\circ\text{C}$  to  $+125^\circ\text{C}$** 

 Test Conditions:  $4.5\text{V} \leq V_{CC} \leq 35\text{V}$  unless otherwise noted.

Parameter	Conditions	Symbol	Minimum	Maximum	Units
Input Voltage, High	$4.5\text{V} \leq V_{CC} \leq 18\text{V}$	$V_{IH}$	3.3	-	V
Input Voltage, Low	$4.5\text{V} \leq V_{CC} \leq 18\text{V}$	$V_{IL}$	-	0.65	
Input Current	$0\text{V} \leq V_{IN} \leq V_{CC}$	$I_{IN}$	-	$\pm 10$	$\mu\text{A}$
Output Voltage, High	-	$V_{OH}$	$V_{CC}-0.025$	-	V
Output Voltage, Low	-	$V_{OL}$	-	0.025	
Output Resistance, High State	$V_{CC}=18\text{V}, I_{OUT}=-100\text{mA}$	$R_{OH}$	-	2	$\Omega$
Output Resistance, Low State	$V_{CC}=18\text{V}, I_{OUT}=100\text{mA}$	$R_{OL}$	-	1.5	
Output Current, Continuous	Limited by package power dissipation	$I_{DC}$	-	$\pm 1$	A
Rise Time	$V_{CC}=18\text{V}, C_{LOAD}=10\text{nF}$	$t_r$	-	40	ns
Fall Time	$V_{CC}=18\text{V}, C_{LOAD}=10\text{nF}$	$t_f$	-	30	
On-Time Propagation Delay	$V_{CC}=18\text{V}, C_{LOAD}=10\text{nF}$	$t_{ondly}$	-	75	
Off-Time Propagation Delay	$V_{CC}=18\text{V}, C_{LOAD}=10\text{nF}$	$t_{offdly}$	-	75	
Enable to Output-High Delay Time	IXDD609 only, $V_{CC}=18\text{V}$	$t_{ENOH}$	-	75	
Disable to High Impedance State Delay Time	IXDD609 only, $V_{CC}=18\text{V}$	$t_{DOLD}$	-	75	
Power Supply Current	$V_{CC}=18\text{V}, V_{IN}=3.5\text{V}$	$I_{CC}$	-	2.5	mA
	$V_{CC}=18\text{V}, V_{IN}=0\text{V}$		-	150	
	$V_{CC}=18\text{V}, V_{IN}=V_{CC}$		-	150	$\mu\text{A}$

### 1.7 Thermal Characteristics

Package	Parameter	Symbol	Rating	Units
D2 (8-Pin DFN)	Thermal Resistance, Junction-to-Ambient	$\theta_{JA}$	35	°C/W
CI (5-Pin TO-220)			36	
PI (8-Pin DIP)			125	
SI (8-Pin Power SOIC)			85	
SIA (8-Pin SOIC)			120	
YI (5-Pin TO-263)			46	
CI (5-Pin TO-220)	Thermal Resistance, Junction-to-Case	$\theta_{JC}$	3	°C/W
SI (8-Pin Power SOIC)			10	
YI (5-Pin TO-263)			2	

## 2 IXD\_609 Performance

### 2.1 Timing Diagrams

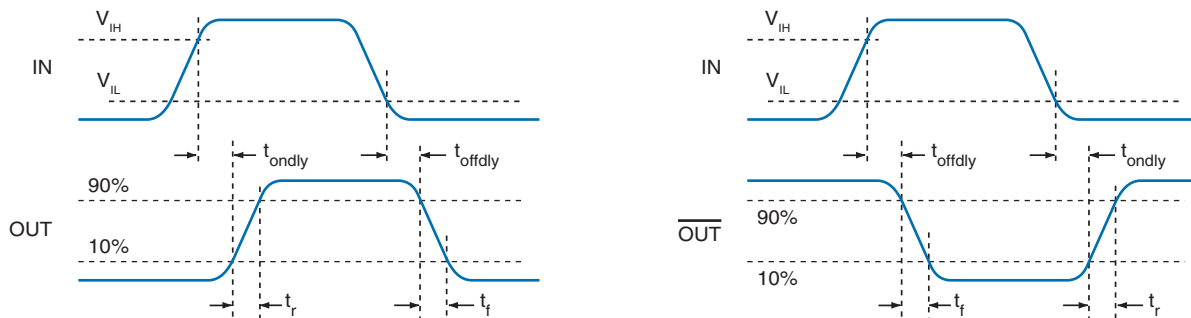

### 2.2 Characteristics Test Diagram

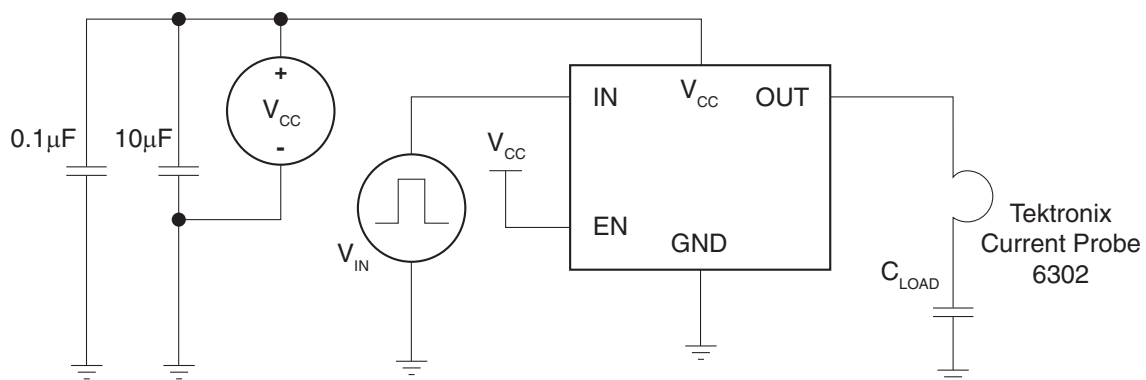

### 3 Block Diagrams & Truth Tables

#### 3.1 IXDD609

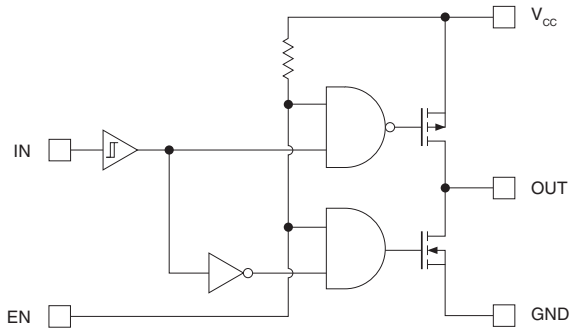

IN	EN	OUT
0	1 or open	0
1	1 or open	1
x	0	Z

#### 3.3 IXDN609

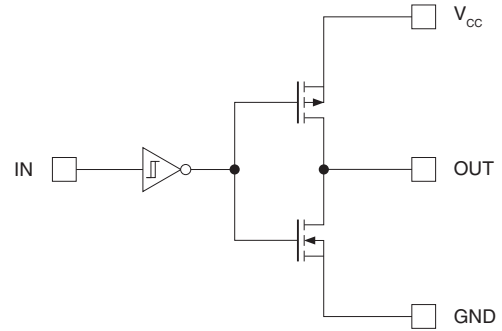

IN	OUT
0	0
1	1

#### 3.2 IXDI609

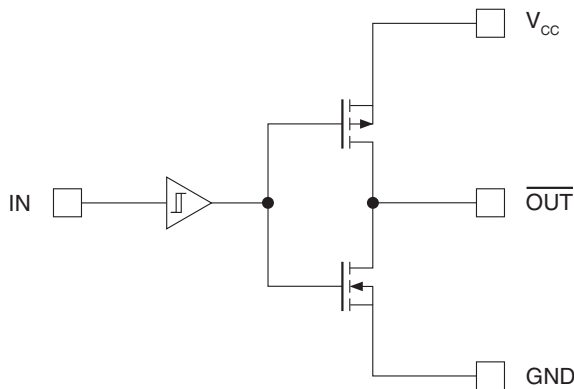

IN	$\overline{\text{OUT}}$
0	1
1	0

## 4 Typical Performance Characteristics

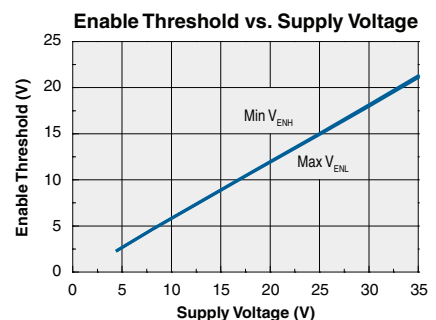
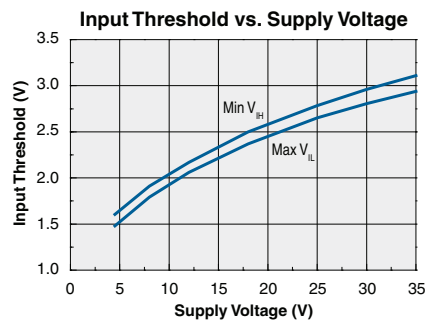
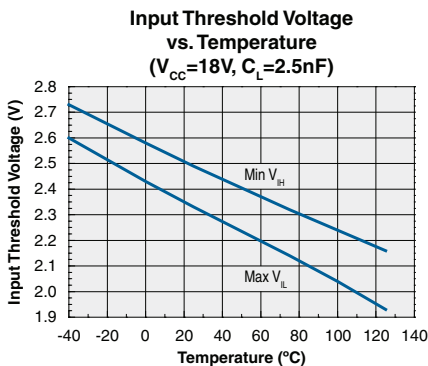
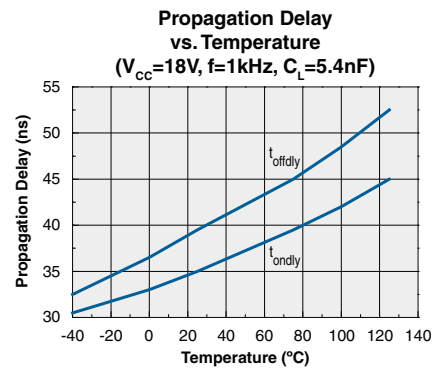
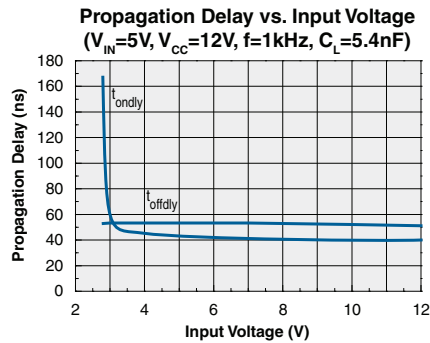
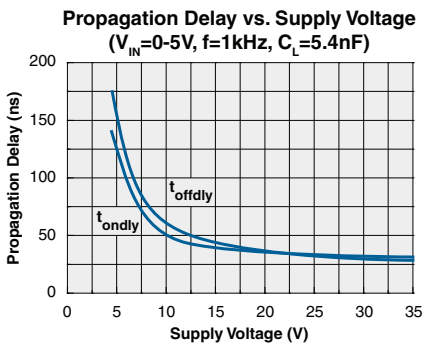
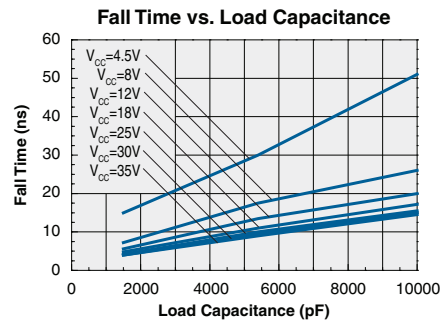
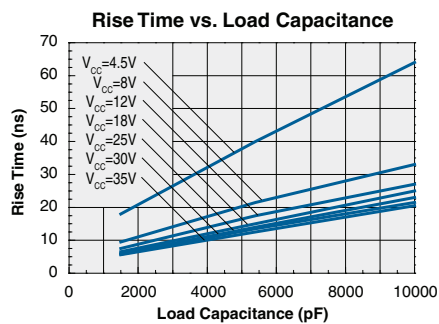
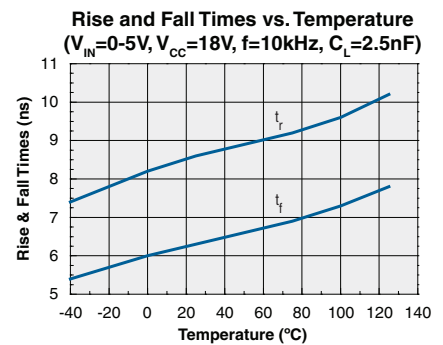
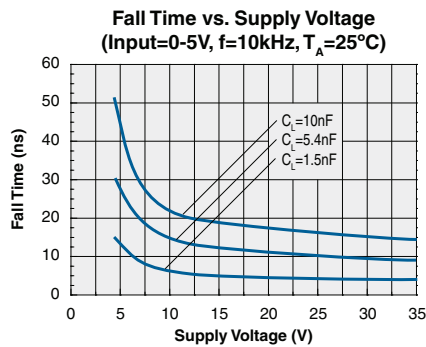
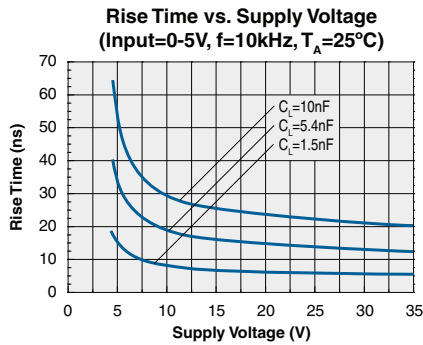

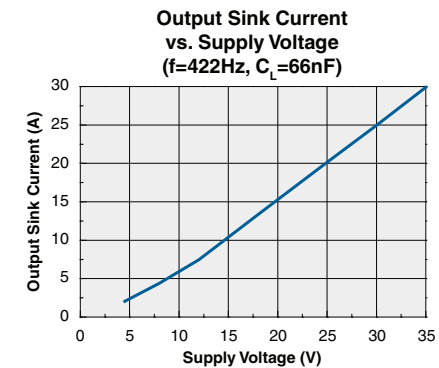
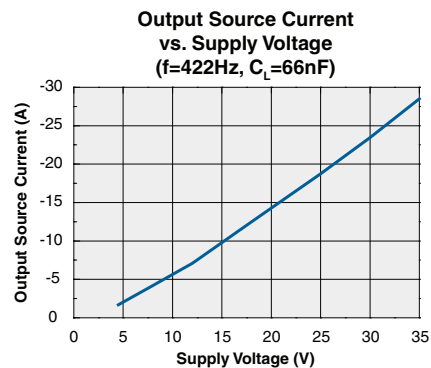
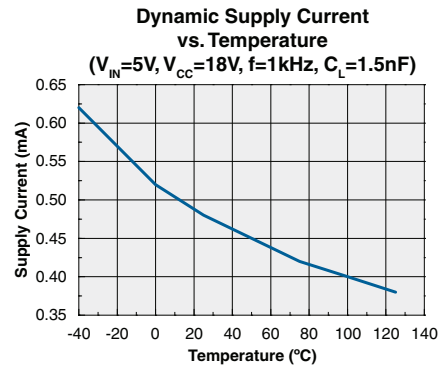
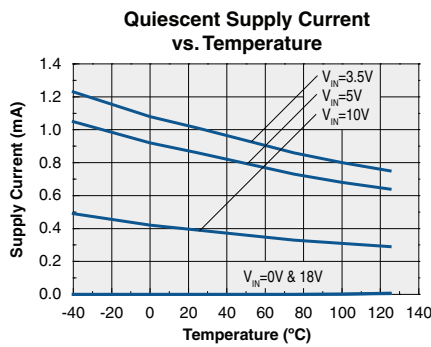
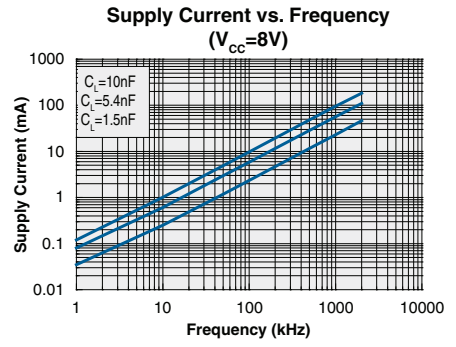
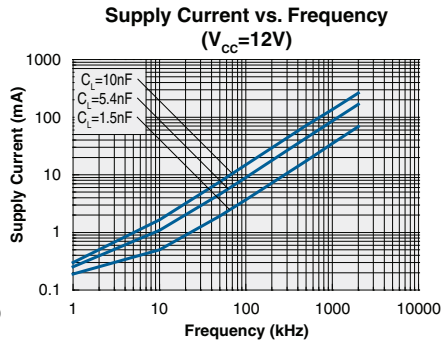
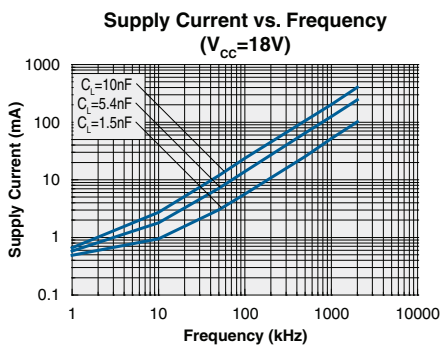
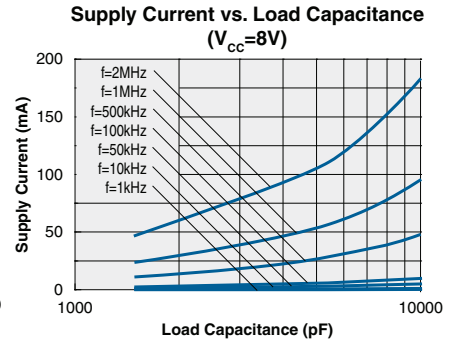
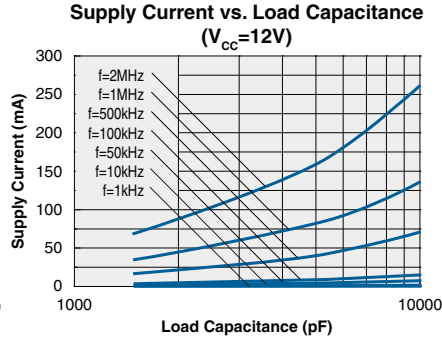
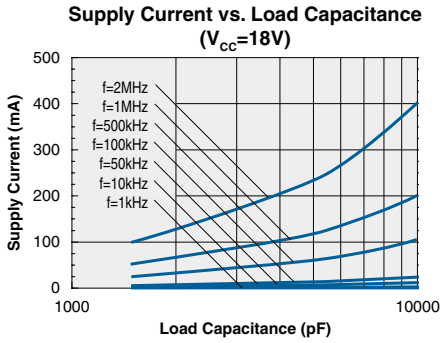



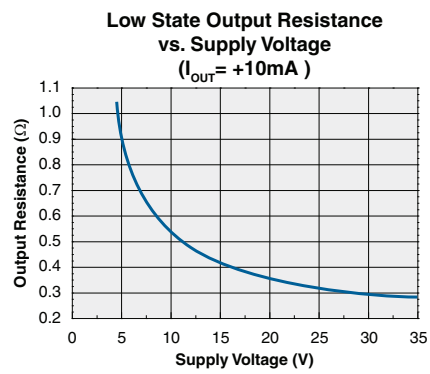
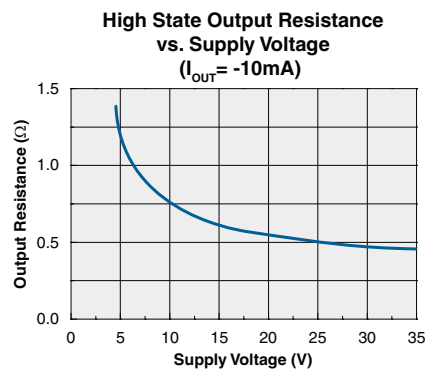
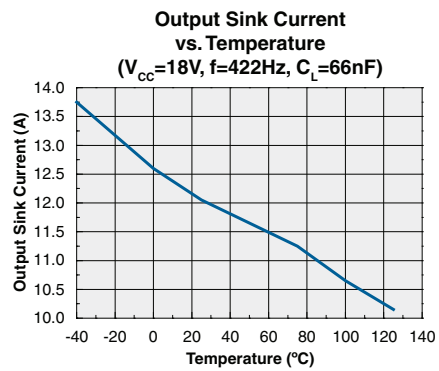
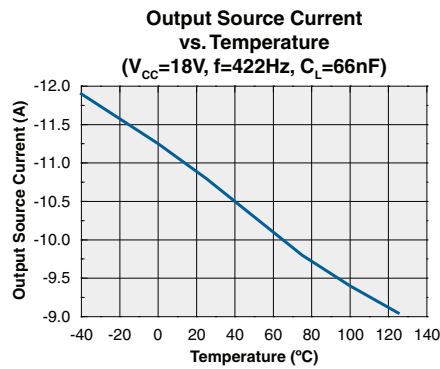

## 5 Manufacturing Information

### 5.1 Moisture Sensitivity



All plastic encapsulated semiconductor packages are susceptible to moisture ingress. Clare classified all of its plastic encapsulated devices for moisture sensitivity according to the latest version of the joint industry standard, **IPC/JEDEC J-STD-020**, in force at the time of product evaluation. We test all of our products to the maximum conditions set forth in the standard, and guarantee proper operation of our devices when handled according to the limitations and information in that standard as well as to any limitations set forth in the information or standards referenced below.

Failure to adhere to the warnings or limitations as established by the listed specifications could result in reduced product performance, reduction of operable life, and/or reduction of overall reliability.

This product carries a **Moisture Sensitivity Level (MSL) rating** as shown below, and should be handled according to the requirements of the latest version of the joint industry standard **IPC/JEDEC J-STD-033**.

Device	Moisture Sensitivity Level (MSL) Rating
IXD_609SI / IXD_609SIA / IXD_609PI / IXD_609CI / IXD_609YI	MSL 1
IXD_609D2	MSL 3

### 5.2 ESD Sensitivity



This product is **ESD Sensitive**, and should be handled according to the industry standard **JESD-625**.

### 5.3 Reflow Profile

This product has a maximum body temperature and time rating as shown below. All other guidelines of **J-STD-020** must be observed.

Device	Maximum Temperature x Time
IXD_609CI / IXD_609YI	245°C for 30 seconds
IXD_609PI	250°C for 30 seconds
IXD_609SI / IXD_609SIA / IXD_609D2	260°C for 30 seconds



## 5.4 Mechanical Dimensions

### 5.4.1 SIA (8-Pin SOIC)

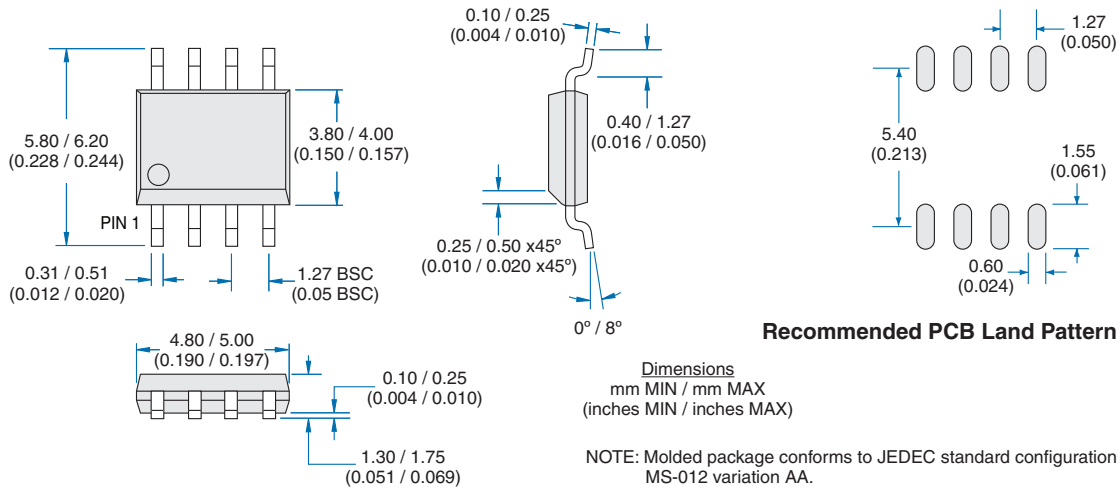

### 5.4.2 SI (8-Pin Power SOIC with Exposed Metal Back)

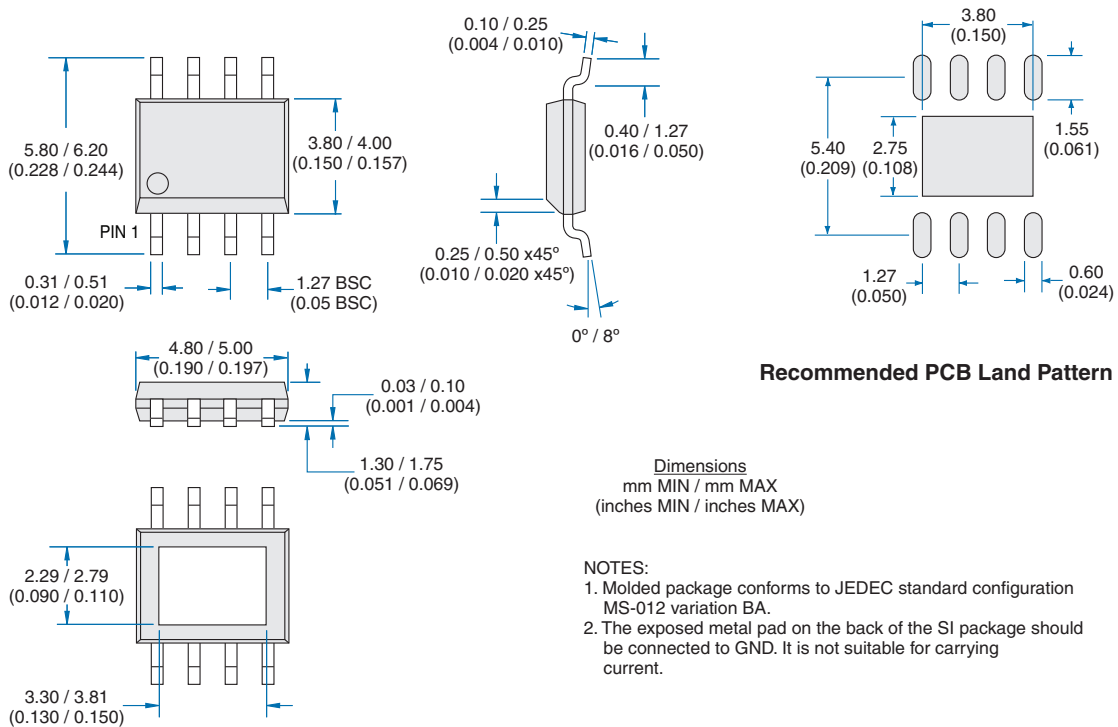

### 5.4.3 Tape & Reel Information for SI and SIA Packages

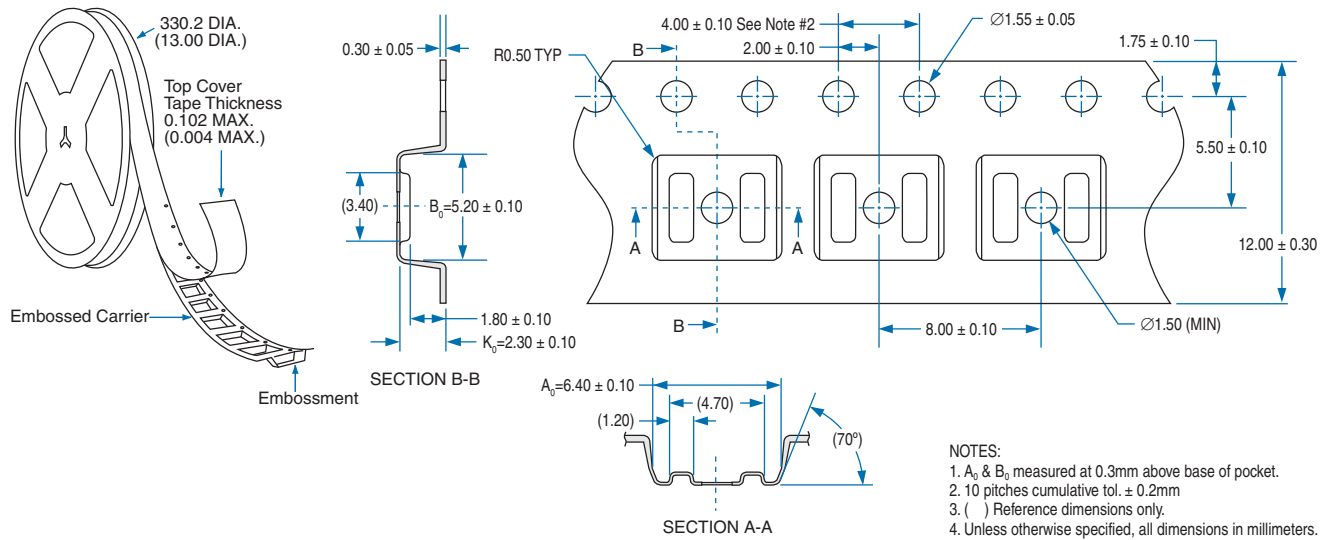

### 5.4.4 YI (5-Pin TO-263)

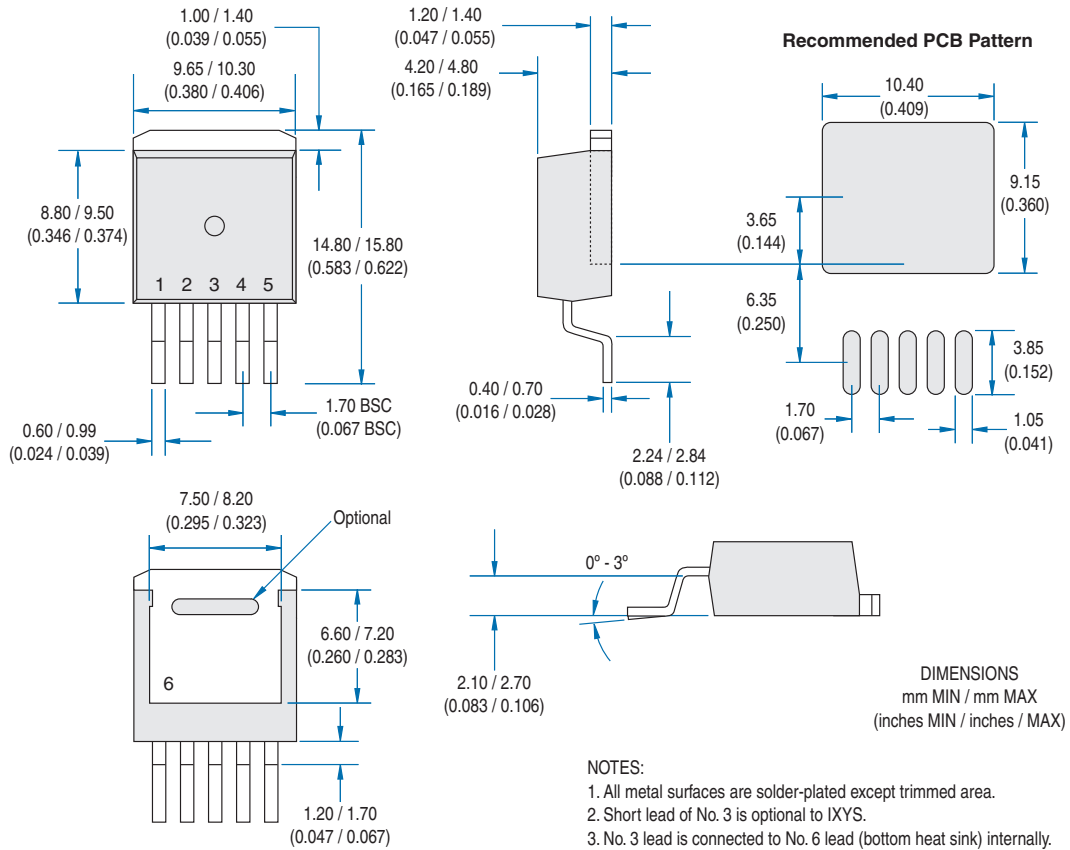

## 5.4.5 PI (8-Pin DIP)

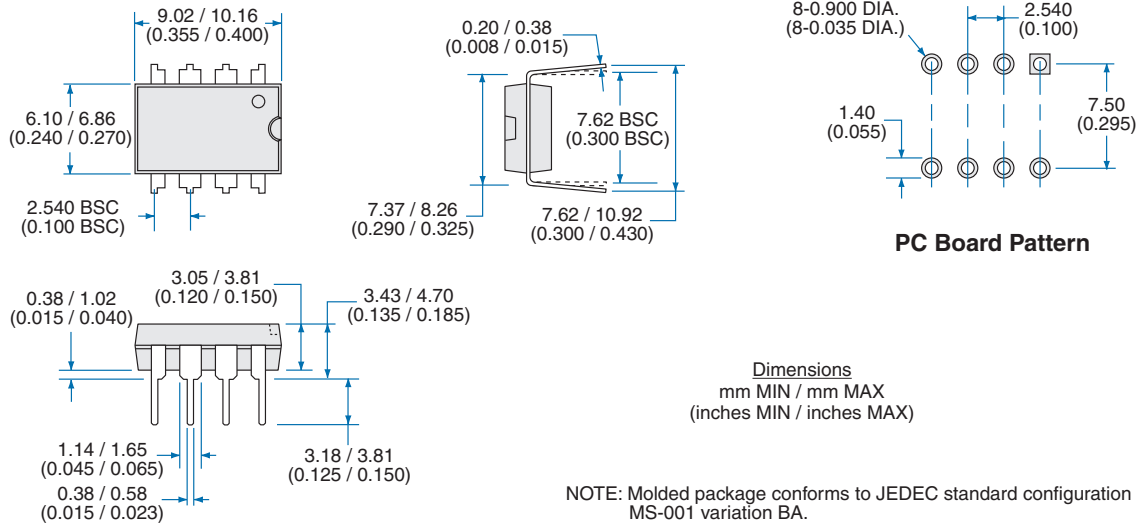

## 5.4.6 CI (5-Pin TO-220)

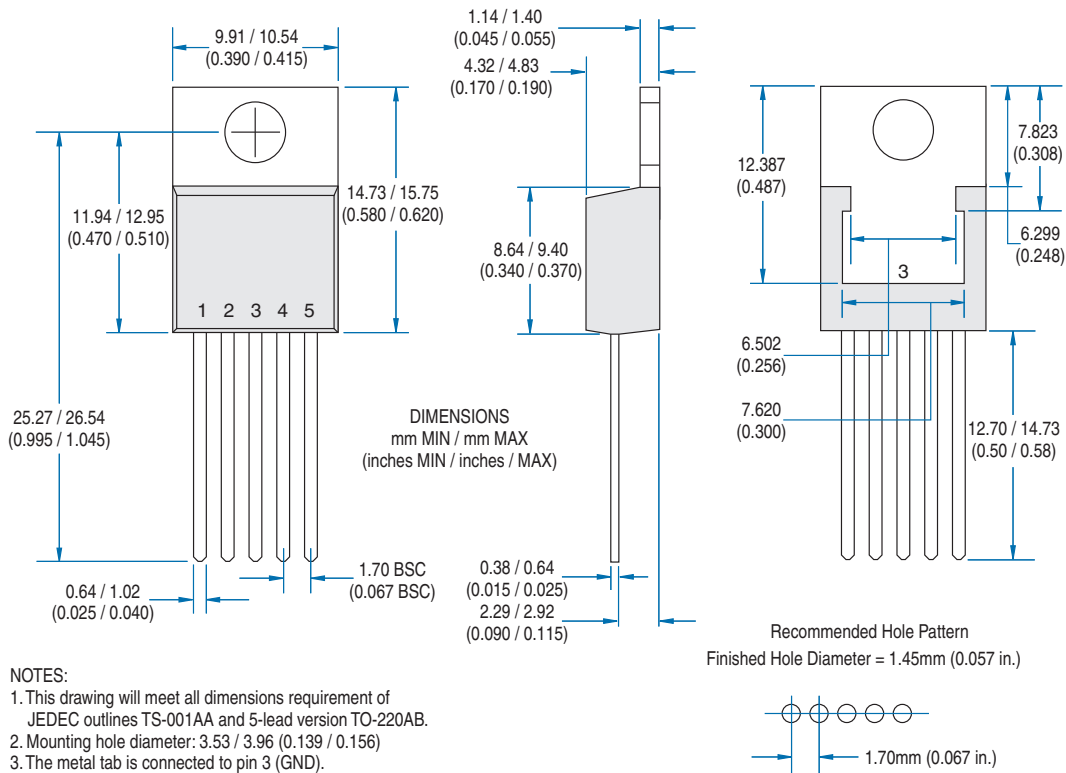

## 5.4.7 D2 (8-Pin DFN)

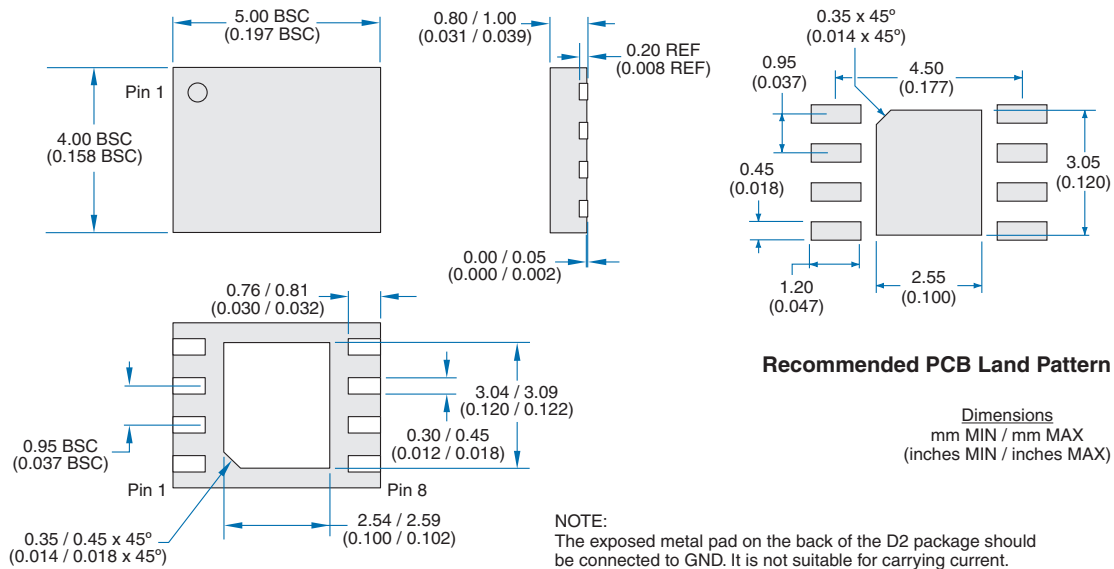

## 5.4.8 Tape & Reel Information for D2 Package

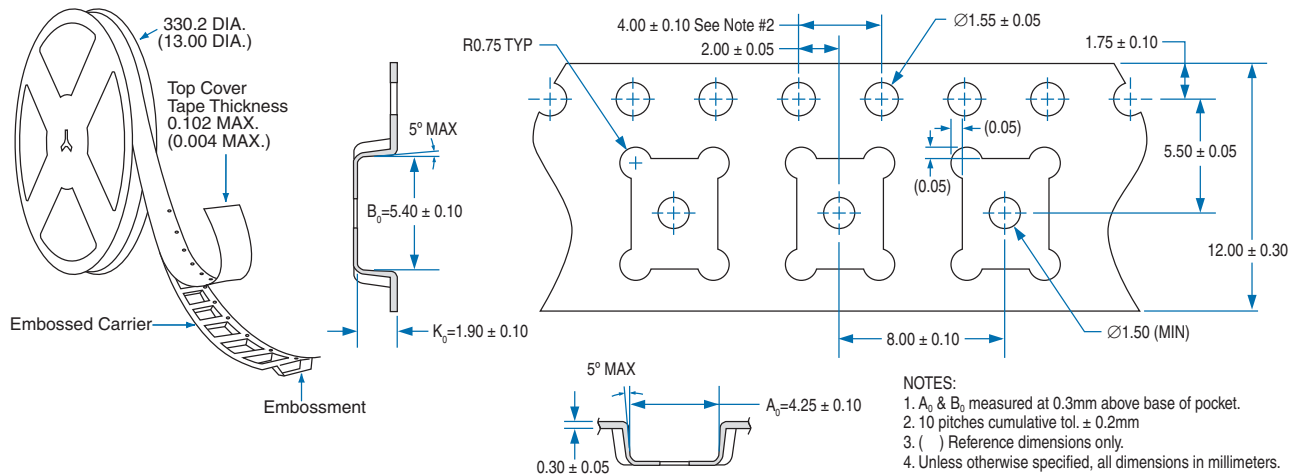

For additional information please visit our website at: [www.clare.com](http://www.clare.com)

Clare, Inc. makes no representations or warranties with respect to the accuracy or completeness of the contents of this publication and reserves the right to make changes to specifications and product descriptions at any time without notice. Neither circuit patent licenses nor indemnity are expressed or implied. Except as set forth in Clare's Standard Terms and Conditions of Sale, Clare, Inc. assumes no liability whatsoever, and disclaims any express or implied warranty, relating to its products including, but not limited to, the implied warranty of merchantability, fitness for a particular purpose, or infringement of any intellectual property right.

The products described in this document are not designed, intended, authorized or warranted for use as components in systems intended for surgical implant into the body, or in other applications intended to support or sustain life, or where malfunction of Clare's product may result in direct physical harm, injury, or death to a person or severe property or environmental damage. Clare, Inc. reserves the right to discontinue or make changes to its products at any time without notice.

Specification: DS-IXD\_609-R02  
©Copyright 2011, Clare, Inc.  
All rights reserved. Printed in USA.  
8/16/2011