



*Best USB Audio I/O Controller for
External High End 8CH Audio Devices*

CM106-F+/L+ High Integrated USB Audio I/O Controller

(Dolby Digital Live and DTS Connect Software Technology Bundle)

DataSheet 1.0

C-MEDIA ELECTRONICS INC.

TEL: 886-2-8773-1100 FAX: 886-2-8773-2211

6F, 100, Sec. 4, Civil Boulevard, Taipei, Taiwan 106, R.O.C.

For detailed product information, please contact sales@cmedia.com.tw

NOTICES

THIS DOCUMENT IS PROVIDED "AS IS" WITH NO WARRANTIES WHATSOEVER, INCLUDING ANY WARRANTY OF MERCHANTABILITY, NONINFRINGEMENT, FITNESS FOR ANY PARTICULAR PURPOSE, OR ANY WARRANTY OTHERWISE ARISING OUT OF ANY PROPOSAL, DOCUMENT OR SAMPLE.

ALL RIGHTS RESERVED. NO PART OF THIS DOCUMENT MAY BE REPRODUCED OR TRANSMITTED IN ANY FORM OR BY ANY MEANS, ELECTRONIC OR MECHANICAL, INCLUDING INFORMATION STORAGE AND RETRIEVAL SYSTEMS, WITHOUT PERMISSION IN WRITING FROM C-MEDIA ELECTRONICS, INC.

COPYRIGHT

Copyright (c) 2005-2007 C-Media Electronics Inc.

All rights reserved. All content included on this document, such as text, graphics, logos, button icons, images, audio clips, digital downloads, data compilations, and software, is either the exclusive property of C-Media Electronics Inc., its affiliates (collectively, "C-Media"), its content suppliers, or its licensors and protected by Republic of China and international copyright laws.

TRADEMARKS

C-Media, the C-Media Logo, Xear 3D, Xear 3D Logo and Speaker Shifter are trademarks of C-Media Electronics Inc. in Republic of China and/or other countries. Dolby Digital and dts are trademarks of Dolby Laboratories, Inc. and DTS Corporate. and All other brand, logos and product names listed are trademarks or registered trademarks of their respective holders and are hereby recognized as such.

C-Media reserves the right to modify the specifications without further notice

Table of Contents

1. DESCRIPTIONS AND OVERVIEW	5
2. FEATURES	6
3. PIN DESCRIPTIONS	8
3.1 CM106-F+ QFP 100 PIN TABLE	8
3.2 CM106-L+ LQFP 48 PIN TABLE	8
3.3 CM106-F+ QFP 100 PIN DESCRIPTION	10
3.4 CM106-L+ LQFP 48 PIN DESCRIPTION	13
4. ORDERING INFORMATION	16
4.1 CM106-L+ (LQFP 48 PIN) PACKAGE	16
4.2 CM106-F+ (QFP 100 PIN) PACKAGE	17
5. FUNCTION BLOCK DIAGRAM OF CM106-F+/L	18
6. FUNCTION DESCRIPTIONS	19
6.1 INTERNAL REGISTER	19
6.2 MCU INTERFACE	22
6.3 SERIAL EEPROM CONTENT	24
6.4 DAC	25
6.5 ADC	25
6.6 POWER MANAGEMENT	25

7. SOFTWARE TECHNOLOGY	26
7.1 Xear 3D™ SOUND	26
7.2 DOLBY® DIGITAL LIVE	27
7.3 DTS® CONNECT	28
8. VOLUME CONTROL	30
8.1 DAC VOLUME CONTROL	30
8.2 ADC VOLUME CONTROL	30
8.3 MIC / LINE-IN MONITOR VOLUME CONTROL	31
9. ELECTRICAL CHARACTERISTICS	32
9.1 ABSOLUTE MAXIMUM RATING	32
9.2 RECOMMENDED OPERATION CONDITIONS	32
9.3 AUDIO PERFORMANCE	33
10. AUDIO PERFORMANCE CURVES	35
10.1 AA PATH (LINE IN TO LINE OUT) FREQUENCY RESPONSE	35
10.2 AA PATH (LINE IN TO LINE OUT) CROSS TALK	35
10.3 DAC (FRONT) FREQUENCY RESPONSE @ 48KS/SEC	36
10.4 DAC (FRONT) FREQUENCY RESPONSE @ 44.1KS/SEC	36
10.5 DAC (FRONT) PASS BAND RIPPLE @ 48KS/SEC	37
10.6 DAC (FRONT) PASS BAND RIPPLE @ 44.1KS/SEC	37
10.7 ADC (LINE IN) FREQUENCY RESPONSE @ 48KS/SEC	38
10.8 ADC (MIC IN) FREQUENCY RESPONSE @ 48KS/SEC	38
11. APPLICATION CIRCUIT	39
11.1 CM106-L+ (LQFP 48) / CM106-F+ (QFP 100)	39

1. DESCRIPTIONS AND OVERVIEW

CM106-F+/ L+ is a highly integrated single chip USB audio solution. All essential analog modules are embedded in CM106F+/L+, including 8CH DAC and earphone buffer, 2CH ADC, microphone booster, PLL, regulator, and USB transceiver. This chip design can provided more efficiency features and high quality sound for high end USB audio products application. It is very suitable for USB external audio box, USB multi-channel headphone, USB Ducking System, USB Portable Home Theater Adoptor and USB audio interface multi-channel speaker set application.

CM106F+/L+ is design for all kind of PC base USB multi-media audio device products. It is USB 2.0 full speed compatible and utilizes USB bus power for plug-and-play feature. Via C-Media Xear 3D Sound USB audio driver, users can avail themselves of a much better virtual 7.1 CH environment capable. Moreover, Xear 3D sound also supported unique enviromentFX, 10 band equalizer sound effects and Karaoke function. For high-end consumer application, this multi-media audio device can easy to processing any sound source to Dolby Digital AC-3 and DTS interactive raw data by real-time encoding function. The world first innovation software function to grade up every PC system and output high quality digital sound effects for link up with high-end home theater equipments like amplifier, DVD player or decoder etc.

These special features are Dolby Digital Live and DTS Connect function modules. As we know, Dolby Digital and DTS (Digital Theater System) are the world well-known sound technology brands and generality using on consumer electronics. Therefore, if PC products need to be home theater equipment or media center this would be key feature and selling point for product development. These functions not only provide easy bridge to connect PCs and consumer electronics but also adding value and upgrade sound quality to PC products. In the future, PCs can put on Dolby Digital and DTS logo on it and provide advanced sound quality to end-user. All of modules were implemented by C-Media in software technology and anyone can request these features by license from Dolby Lab. and DTS Corporate. through C-Media.

Furthermore, Many features are programmable with external EEPROM and MCU interface. In addition, Venders can using MCU/EEPROM/GPIO control interface easily via HID software to develop remote control or keypad button functions. Better yet, CM106-F+/L support stereo MIC, phone jack sense, S/PDIF I/O and 48/44.1 Khz sampling rate.

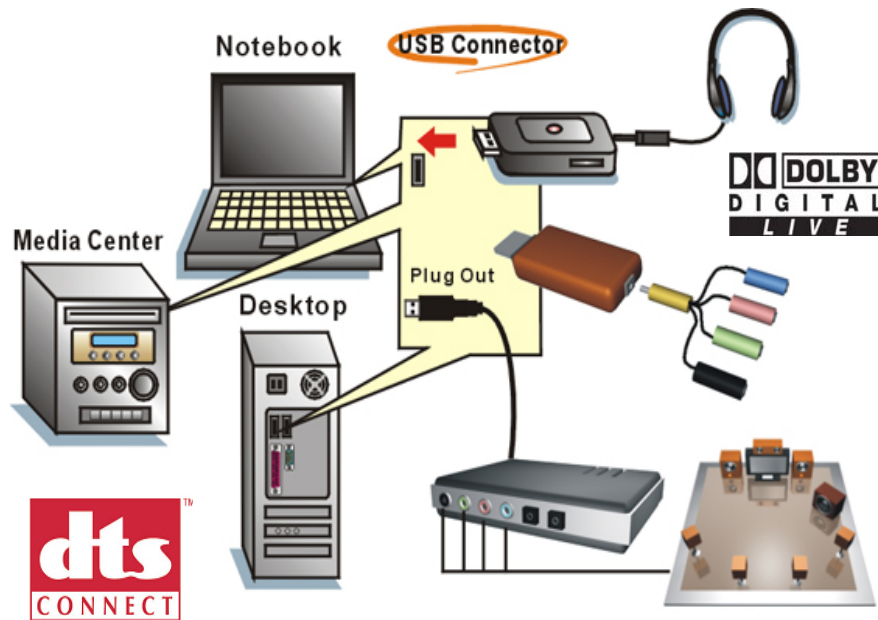

2. FEATURES

- USB spec. 2.0 full speed compliant and USB IF certification
- USB audio device class spec. 1.0 and USB HID class spec. 1.1 compliant
- IEC60958 spec. Compliant (consumer format S/PDIF input and output with loop-back support)
- SCMS (Serial Copy Management System) compliant
- Dolby® Digital and DTS audio streaming via S/PDIF out
- USB remote wake-up support
- 8 channel DAC output with
 - 16 bit resolution
 - 3.1 Vpp (1.1 Vrms) biased at 2.25V output swing
 - Volume control and mute function
 - Earphone buffer
 - 2X interpolator for digital playback data to improve quality
- 2 channel ADC input with
 - 16 bit resolution
 - 3.2 Vpp (or 4.0 Vpp programmed by vendor driver) biased at 2.25V input swing
 - Volume control and mute function

- Additional headphone output with selectable source and phone jack sense
- Stereo MIC support with boost capability
- Recording source select from S/PDIF, MIC, Line-in and summation of MIC, Line-in and front channel
- MIC, Line-in monitor from front channel (all channels optional) with volume control and mute function
- Master volume control by default; per-channel volume control by C-Media driver
- Playback with soft-mute function
- Support 48 / 44.1 KHz sampling rate for both playback and recording
- MCU support with two-wire serial interface
- Serial EEPROM support for customized VID/PID
- MCU / EEPROM / GPIO control via HID software interface
- Volume up / volume down / playback mute HID button
- LED indicator pins: operation / recording mute / SCMS protection
- Embedded USB transceiver and power on reset circuit
- Single 12MHz crystal input with embedded PLL
- Single 5V power supply with embedded 5V to 3.3V regulator
- Industry standard LQFP-48 (CM106-L+) or QFP-100 (CM106-F+) package
- C-Media value added patent software driver
 - Xear 3D sound
 - Earphone Plus
 - SPEAKER SHIFTER
 - Environment sound effects
 - Room Size Mode
 - Graphic Equalizer
 - Karaoke Function
- Software Driver support Dolby Digital Live for multi-media content real-time encoder with Dolby Digital AC-3 Raw data bit stream
- Software Driver support DTS Connect with DST Interactive and DTS NEO:PC sound technology
 - DST Interactive > multi-media content real-time encoder with DTS Raw data bit stream
 - NEO:PC > audio up-mix matrix technology that turns any 2 channel audio into 7.1 surrounds sound.

3. PIN DESCRIPTIONS

3.1 CM106-F+ QFP 100PIN TABLE

PIN #	Signal Name	PIN #	Signal Name	PIN #	Signal Name	PIN #	Signal Name
1~7	NC	31~34	NC	61	LOCF	85	XO
8	DVSS5	35	LIL	62	LOLFE	86	DVSS1
9	PHONES	36	LIR	63	AVSS2	87	PWRSEL
10	CS	37	AVDD1	64	DVSS6	88	PWRSEL1
11	SK	38	VREF	65	VOLUP	89	DVSS3
12	DR	39	VBIAS	66	VOLDN	90	SDAT
13	DW	40	AVSS1	67	SPDIFI	91	SCLK
14	MSEL1	41	HPOUTL	68	MUTER	92	TEST
15	MSEL2	42	HPOUTR	69	MUTEP	93	MCLK
16	DVSS2	43	LOSL	70	SPDIFO	94	DVSS4
17	USBDP	44	LOSR	71	GPIO2	95	MINT
18	USBDM	45	LOFL	72	GPIO3	96	GPIO1
19	REGV	46	LOFR	73	GPIO4	97	LEDO
20	DVDD1	47~50	NC	74	DVSS7	98	LEDR
21	AVSS3	51~57	NC	75~80	NC	99	LEDS
22	MICINL	58	AVDD2	81~82	NC	100	NC
23	MICINR	59	LOLS	83	PDSW		
24~30	NC	60	LORS	84	XI		

3.2 CM106-L+ LQFP 48PIN TABLE

PIN #	Signal Name	PIN #	Signal Name	PIN #	Signal Name
1	PDSW	17	DW	33	LOSL
2	XI	18	USBDP	34	LOSR
3	XO	19	USBDM	35	LOFL
4	DVSS1	20	REGV	36	LOFR
5	SDAT	21	DVDD1	37	AVDD2
6	SCLK	22	AVSS3	38	LOLS
7	TEST	23	MICINL	39	LORS
8	MCLK	24	MICINR	40	LOCF
9	MINT	25	LIL	41	LOLFE
10	GPIO1	26	LIR	42	AVSS2
11	LEDO	27	AVDD1	43	VOLUP
12	LEDR	28	VREF	44	VOLDN
13	PHONES	29	VBIAS	45	SPDIFI
14	CS	30	AVSS1	46	MUTER
15	SK	31	HPOUTL	47	MUTEP
16	DR	32	HPOUTR	48	SPDIFO

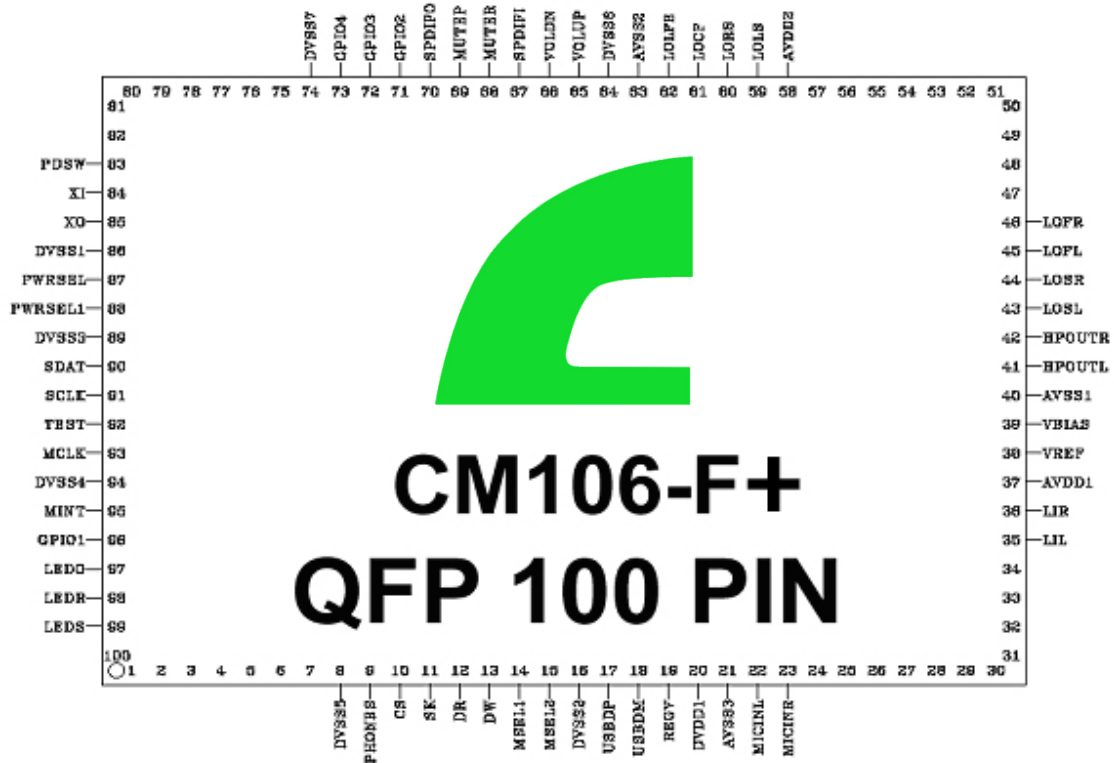

Figure 1. CM106-F+ QFP 100 Pin Assignments (Top View)

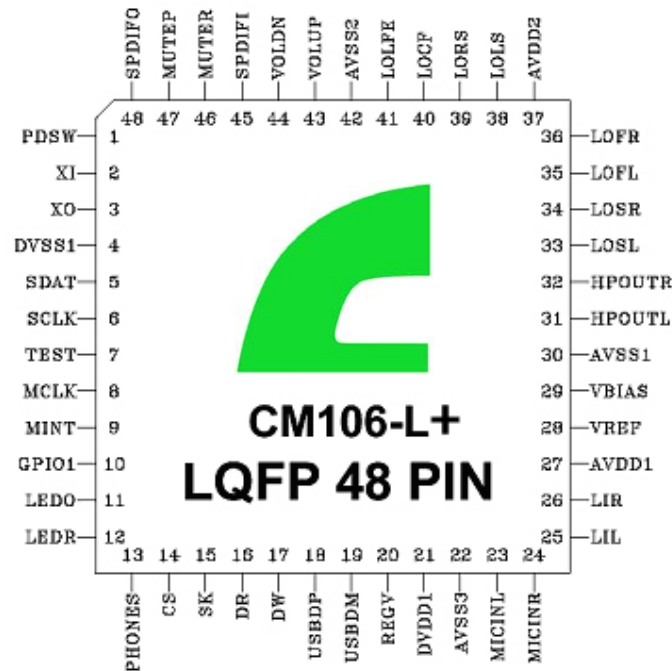

Figure 2. CM106-L+ LQFP 48 Pin Assignments (Top View)

3.3 CM106-F+ QFP 100 PIN DESCRIPTION

Pin #	Symbol	Type	Description
1~7	NC	--	--
8	DVSS5	P	Digital ground
9	PHONES	DI	Phone jack sense pin for line out Tri-state; an internal register bit will be set when activated (active H)
10	CS	DO	EEPROM interface chip select
11	SK	DO	EEPROM interface clock
12	DR	DO	EEPROM interface data read
13	DW	DI	EEPROM interface data write
14	MSEL1	DI	0: MICINL/R and LIL/R mix to 8 channels 1: MICINL/R and LIL/R mix to LOFL and LOFR
15	MSEL2	DI	0: playback only 1: playback and recording
16	DVSS2	P	Digital ground
17	USBDP	AIO	USB data D+
18	USBDM	AIO	USB data D-
19	REGV	AO	3.3V reference output for internal 5 → 3.3V regulator
20	DVDD1	P	5V power supply to internal regulator
21	AVSS3	P	Analog ground
22	MICINL	AI	Microphone input left channel
23	MICINR	AI	Microphone input right channel
24~30	NC	--	--
31~34	NC	--	--
35	LIL	AI	Line-In input left channel
36	LIR	AI	Line-In input right channel
37	AVDD1	P	5V analog power for analog circuit
38	VREF	AO	Connecting to external decoupling capacitor for embedded band-gap circuit; 2.25V output

Pin #	Symbol	Type	Description
39	VBIAS	AO	Microphone bias voltage supply (4.5V/2.25V)
40	AVSS1	P	Analog ground
41	HPOUTL	AO	Headphone out left channel
42	HPOUTR	AO	Headphone out right channel
43	LOSL	AO	Line out side (back) left channel
44	LOSR	AO	Line out side (back) right channel
45	LOFL	AO	Line out front left channel
46	LOFR	AO	Line out front right channel
47~50	NC	--	--
51~57	NC	--	--
58	AVDD2	P	5V analog power for analog circuit
59	LOLS	AO	Line out surround (rear) left channel
60	LORS	AO	Line out surround (rear) right channel
61	LOCF	AO	Line out center channel
62	LOLFE	AO	Line out LFE (subwoofer) channel
63	AVSS2	P	Analog ground
64	DVSS6	P	Digital ground
65	VOLUP	DI	Volume up (edge trigger with de-bouncing)
66	VOLDN	DI	Volume down (edge trigger with de-bouncing)
67	SPDIFI	DI	S/PDIF input
68	MUTER	DI	Mute recording (edge trigger with de-bouncing)
69	MUTEP	DI	Mute playback (edge trigger with de-bouncing)
70	SPDIFO	DO	S/PDIF output
71	GPIO2	DIO	GPIO pin #2
72	GPIO3	DIO	GPIO pin #3
73	GPIO4	DIO	GPIO pin #4
74	DVSS7	P	Digital ground

Pin #	Symbol	Type	Description
75~80	NC	--	--
81~82	NC	--	--
83	PDSW	DO	Power down switch control (for PMOS polarity) 0: normal mode 1: power down mode
84	XI	DI	12MHz crystal, or oscillator input
85	XO	DO	12MHz crystal output
86	DVSS1	P	Digital ground
87	PWRSEL	DI	0: self power 1: bus power
88	PWRSEL1	DI	0: 100mA operation current 1: 500mA operation current
89	DVSS3	P	Digital ground
90	SDAT	DIO	External MCU serial bus data pin
91	SCLK	DI	External MCU serial bus clock pin
92	TEST	DI	Test mode select pin; pull low in normal operation
93	MCLK	DO	External MCU clock pin; clock frequency is programmable (12MHz, 6MHz, 3MHz, 1.5MHz) Default is 1.5 MHz
94	DVSS4	DO	Digital ground
95	MINT	DO	External MCU interrupt pin (active L) When internal register address 0 ~ 3 or external serial EEPROM is accessed, MINT is set low; after MCU read, MINT is reset to H
96	GPIO1	DIO	GPIO pin #1
97	LEDO	DO	LED for operation; output H for power on; toggling for data transmit
98	LEDR	DO	LED for mute recording indication; output H when recording is muted
99	LEDS	DO	LED for SCMS indication; output H when S/PDIF input is not authorized to record
100	NC	--	--

3.4 CM106-L+ LQFP 48 PIN DESCRIPTION

Pin #	Symbol	Type	Description
1	PDSW	DO	Power down switch control (for PMOS polarity) 0: normal mode 1: power down mode
2	XI	DI	12MHz crystal, or oscillator input
3	XO	DO	12MHz crystal output
4	DVSS1	P	Digital ground
5	SDAT	DIO	External MCU serial bus data pin
6	SCLK	DI	External MCU serial bus clock pin
7	TEST	DI	Test mode select pin; pull low in normal operation
8	MCLK	DO	External MCU clock pin; clock frequency is programmable (12MHz, 6MHz, 3MHz, 1.5MHz) Default is 1.5 MHz
9	MINT	DO	External MCU interrupt pin (active L) When internal register address 0 ~ 3 or external serial EEPROM is accessed, MINT is set low; after MCU read, MINT is reset to H
10	GPIO1	DIO	GPIO pin #1
11	LEDO	DO	LED for operation; output H for power on; toggling for data transmit
12	LEDR	DO	LED for mute recording indication; output H when recording is muted
13	PHONES	DI	Phone jack sense pin for line out Tri-state; an internal register bit will be set when activated (active H)
14	CS	DO	EEPROM interface chip select
15	SK	DO	EEPROM interface clock
16	DR	DO	EEPROM interface data read
17	DW	DI	EEPROM interface data write
18	USBDP	AIO	USB data D+
19	USBDM	AIO	USB data D-
20	REGV	AO	3.3V reference output for internal 5 → 3.3V regulator
21	DVDD1	P	5V power supply to internal regulator
22	AVSS3	P	Analog ground
23	MICINL	AI	Microphone input left channel

Pin #	Symbol	Type	Description
24	MICINR	AI	Microphone input right channel
25	LIL	AI	Line-In input left channel
26	LIR	AI	Line-In input right channel
27	AVDD1	P	5V analog power for analog circuit
28	VREF	AO	Connecting to external decoupling capacitor for embedded band-gap circuit; 2.25V output
29	VBIAS	AO	Microphone bias voltage supply (4.5V/2.25V)
30	AVSS1	P	Analog ground
31	HPOUTL	AO	Headphone out left channel
32	HPOUTR	AO	Headphone out right channel
33	LOSL	AO	Line out side (back) left channel
34	LOSR	AO	Line out side (back) right channel
35	LOFL	AO	Line out front left channel
36	LOFR	AO	Line out front right channel
37	AVDD2	P	5V analog power for analog circuit
38	LOLS	AO	Line out surround (rear) left channel
39	LORS	AO	Line out surround (rear) right channel
40	LOCF	AO	Line out center channel
41	LOLFE	AO	Line out LFE (subwoofer) channel
42	AVSS2	P	Analog ground
43	VOLUP	DI	Volume up (edge trigger with de-bouncing)
44	VOLDN	DI	Volume down (edge trigger with de-bouncing)
45	SPDIFI	DI	S/PDIF input
46	MUTER	DI	Mute recording (edge trigger with de-bouncing)
47	MUTEP	DI	Mute playback (edge trigger with de-bouncing)
48	SPDIFO	DO	S/PDIF output

*Note 1: DI – digital input pad

DO – digital output pad

DIO – digital bi-directional pad

AI/AO/AIO – analog pad

P – power pad

*Note 2: For LQFP 48 package, PWRSEL, PWRSEL1, MSEL1 and MSEL2 are internal bonding options; They are not bonded by default.

4. ORDERING INFORMATION

4.1 CM106-L+ (LQFP48) PACKAGE

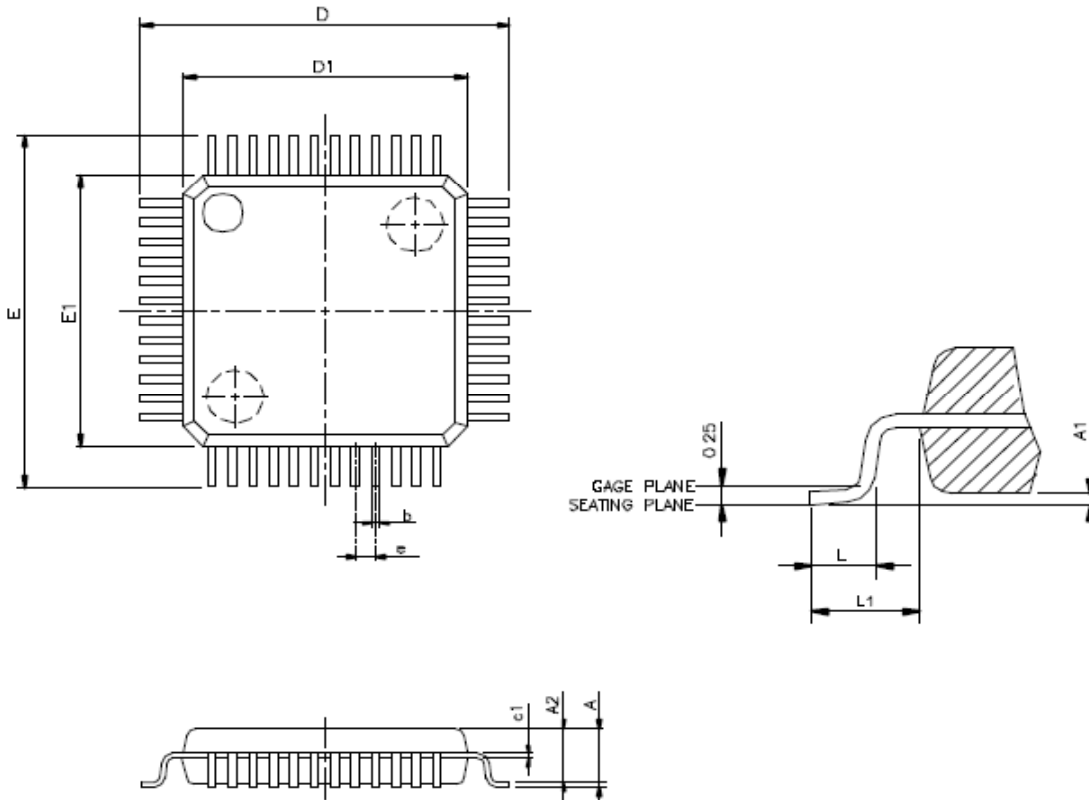

VARIATIONS (ALL DIMENSIONS SHOWN IN MM)

SYMBOLS	MIN.	MAX.
A	--	1.6
A1	0.05	0.15
A2	1.35	1.45
c1	0.09	0.16
D	9.00 BSC	
D1	7.00 BSC	
E	9.00 BSC	
E1	7.00 BSC	
e	0.5 BSC	
b	0.17	0.27
L	0.45	0.75
L1	1 REF	

NOTES:

1. JEDEC OUTLINE: MS-026 BBC
2. DIMENSIONS D1 AND E1 DO NOT INCLUDE MOLD PROTRUSION. ALLOWABLE PROTRUSION IS 0.25mm PER SIDE. D1 AND E1 ARE MAXIMUM PLASTIC BODY SIZE DIMENSIONS INCLUDING MOLD MISMATCH.
3. DIMENSION b DOES NOT INCLUDE DAMBAR PROTRUSION. ALLOWABLE DAMBAR PROTRUSION SHALL NOT CAUSE THE LEAD WIDTH TO EXCEED THE MAXIMUM b DIMENSION BY MORE THAN 0.08mm.

4.2 CM106-F+ (QFP100) PACKAGE

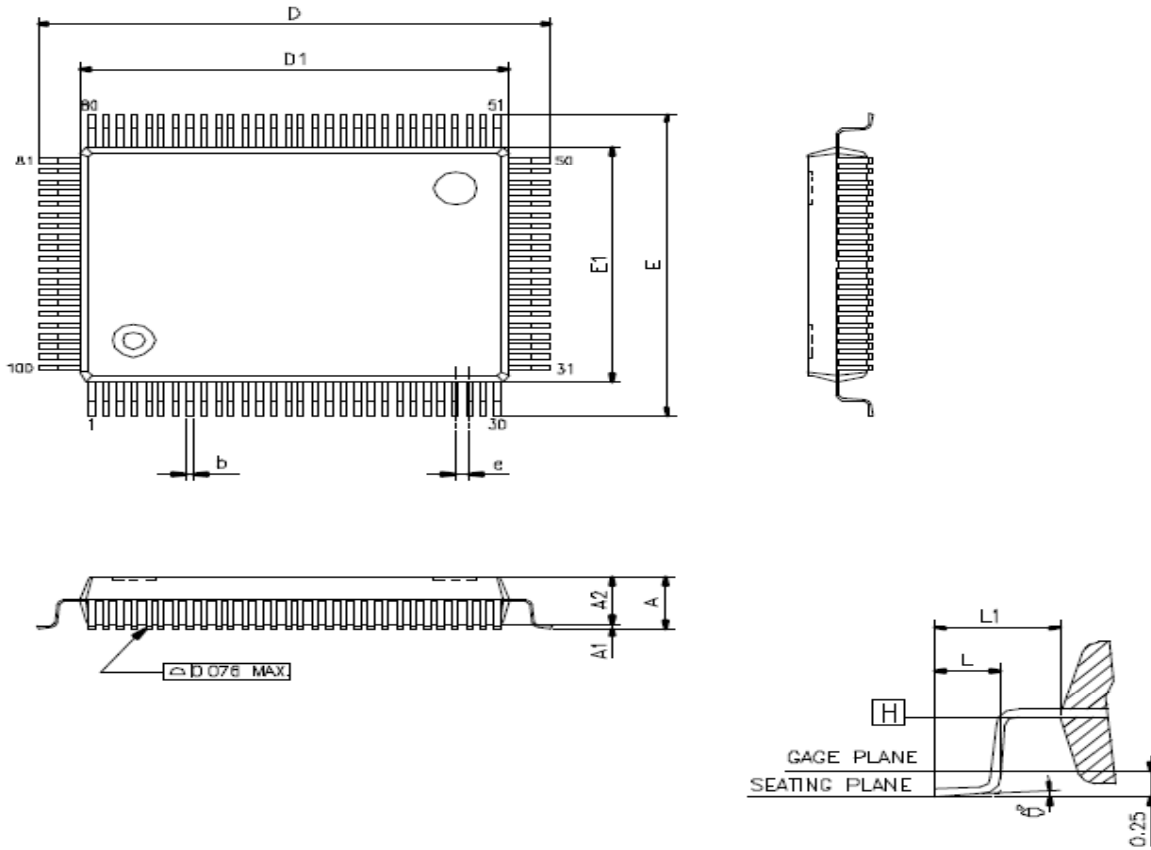

SYMBOLS	MIN.	NOM	MAX.
A	-	-	3.30
A1	0.25	-	-
A2	2.68	2.80	2.92
b	0.20	0.30	0.40
D	24.49	24.80	25.10
D1	19.90	20.00	20.10
e	0.50	0.65	0.8
E	18.48	18.80	19.10
E1	13.90	14.00	14.10
L	1.00	1.20	1.40
L1	2.21	2.40	2.59
θ°	0	-	12

UNIT : mm

NOTES.

1. JEDEC OUTLINE: MO-112 CC-1
2. DATUM PLANE [H] IS LOCATED AT THE BOTTOM OF THE MOLD PARTING LINE COINCIDENT WITH WHERE THE LEAD EXITS THE BODY.
3. DIMENSIONS D1 AND E1 DO NOT INCLUDE MOLD PROTRUSION. ALLOWABLE PROTRUSION IS 0.25 mm PER SIDE. DIMENSIONS D1 AND E1 DO INCLUDE MOLD MISMATCH AND ARE DETERMINED AT DATUM PLANE [H].
4. DIMENSION b DOES NOT INCLUDE DAMBAR PROTRUSION.

5. FUNCTION BLOCK DIAGRAM OF CM106-F+/L+

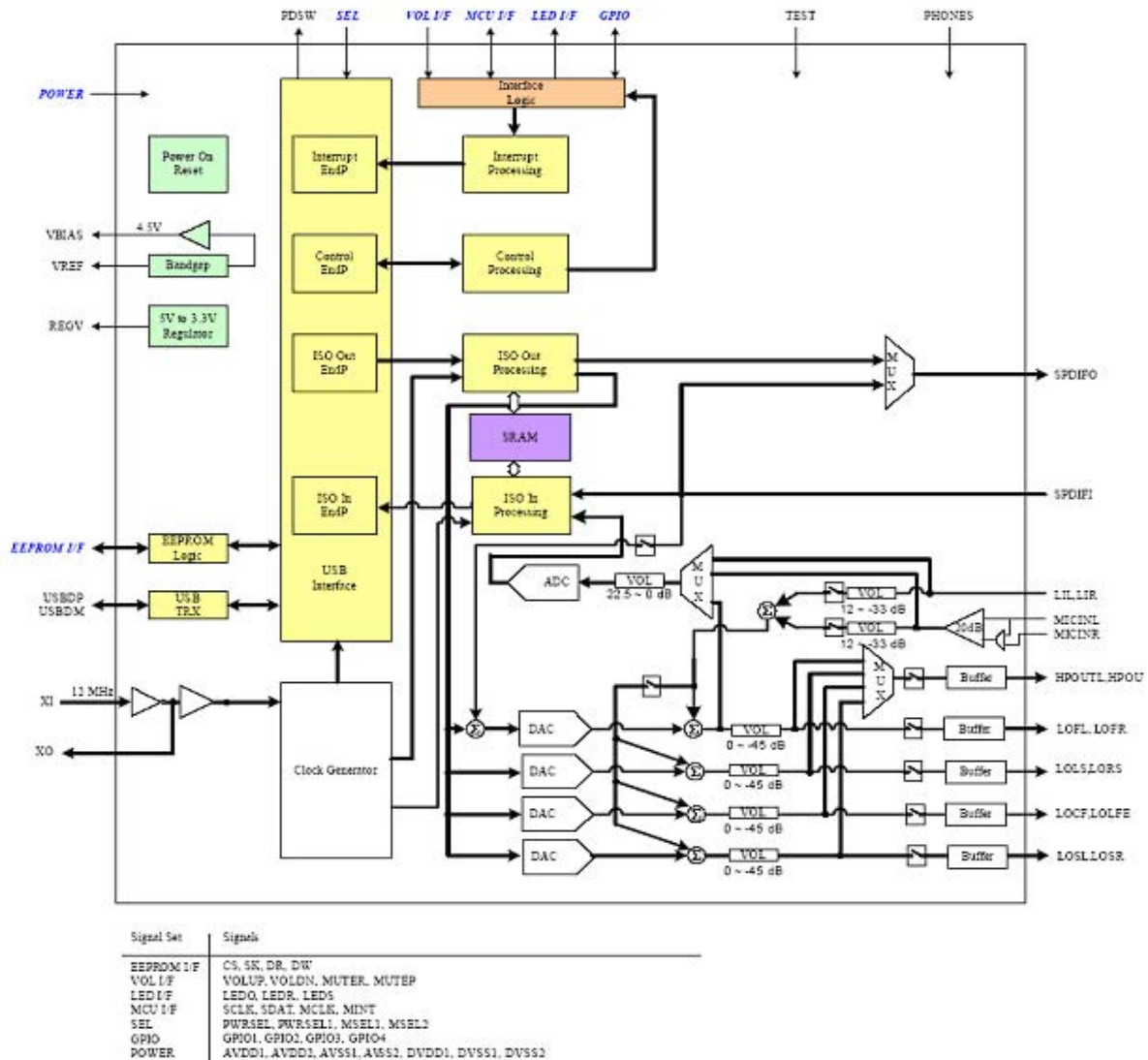

Figure 3 : Function Block Diagram Of CM106-F+/L+

Signal Set	Signals
EEPROM	CS, SK, DR, DW
VOL I/F	VOLUP, VOLDN, MUTER, MUTEP
LED I/F	LEDO, LEDR, LEDS
MCU I/F	SCLK, SDAT, MCLK, MINT
SEL	PWRSEL, PWRSEL1, MSEL1, MSEL2
GPIO	GPIO1, GPIO2, GPIO3, GPIO4
Power	AVDD1, AVDD2, AVSS1, AVSS2, DVDD1, DVSS1, DVSS2

6. FUNCTION DESCRIPTION

6.1 INTERNAL REGISTER

The internal registers of CM106F+/L+ can be divided to two parts. Some of them (REG0, REG1, REG2 and REG3) are 16-bit width and can be accessed via HID interface. The others are 8-bit width and can be accessed by vendor requests. To access registers via HID interface, users should issue a “Set Output Report” HID request. The four bytes of output report data is organized as below:

Byte [0]	Read: 8'd48 Write: 8'd32
Byte [1]	DATAL
Byte [2]	DATAH
Byte [3]	Register address (0, 1, 2, 3)

In addition to internal registers, users can also access external serial EEPROM by the same way:

Byte [0]	Read: 8'd80 Write: 8'd64
Byte [1]	DATAL
Byte [2]	DATAH
Byte [3]	EEPROM address (0 ~ 8'd63)

When users intend to read register / EEPROM by “Set Output Report”, the returned data will be transferred to USB host via HID input report through interrupt pipe. The three bytes of input report data is organized as below:

Byte [0]	MCUIN	EEIN	REGIN	HEADPON		MUTE	VDN	VUP
Byte [1]	DATAL from MCU when MCUIN = 1 DATAL from EEPROM when EEIN = 1 DATAL from Register when REGIN = 1							
Byte [2]	DATAH from MCU when MCUIN = 1 DATAH from EEPROM when EEIN = 1 DATAH from Register when REGIN = 1							

Users can distinguish the source of input report by Byte[0], Byte[1] and Byte[2] consist a word which may be the content of addressed register or serial EEPROM. It may also be an arbitrary word programmed by external MCU. In addition, Byte[0] carries the information of HID button status (MUTE, VDN and VUP), and phone jack sense (HEADPON). VDN/VUP would be 1 when VOLDN/VOLUP button is pressed, and keeps pressed (VOLDN/VOLUP keeps 0). MUTE would be 1 when MUTE button is pressed, and would be cleared to 0 after USB host reads the input report. HEADPON would be 1 when headphone is plugged in (PHONES is 1).

Refer to the following tables for the definition of internal registers can be accessed via HID interface:

REG0	Address: 0x00
	Reset State: 0x0000

15	14	13	12	11	10	9	8	7	6	5	4	3	2	1	0
CSR															

Bit Number	Bit Mnemonic	Read/Write	Function
12-0	CSR	R/W	SPDIF out control

REG1	Address: 0x01
	Reset State: 0xb000

15	14	13	12	11	10	9	8
DACX2en	FS	PLLBINen	SOFTMUTEen	GPIO4_o	GPIO4_OEN	GPIO3_o	GPIO3_OEN

7	6	5	4	3	2	1	0
GPIO2_o	GPIO2_OEN	GPIO1_o	GPIO1_OEN	LOWFIRSET	SPDIFLOOP	DIS_SPDIFO	SPDIFMIX

Bit Number	Bit Mnemonic	Read/Write	Function
15	DACX2en	R/W	DAC X 2 enable
14	FS	R/W	ADC full scale setting
13	PLLBINen	R/W	PLL binary search enable
12	SOFTMUTEen	R/W	Soft mute enable
11	GPIO4_o	R/W	Gpio4 signal
10	GPIO4_OEN	R/W	Gpio4 output enable
9	GPIO3_o	R/W	Gpio3 signal
8	GPIO3_OEN	R/W	Gpio3 output enable
7	GPIO2_o	R/W	Gpio2 signal

Bit Number	Bit Mnemonic	Read/Write	Function
6	GPIO2_OEN	R/W	Gpio2 output enable
5	GPIO1_o	R/W	Gpio1 signal
4	GPIO1_OEN	R/W	Gpio1 output enable
3	LOWFIRSET	R/W	Low pass filter setting
2	SPDIFLOOP	R/W	SPDIF loop-back enable
1	DIS_SPDIFO	R/W	SPDIF out disable
0	SPDIFMIX	R/W	SPDIF in mix enable

REG2	Address:	0x02
	Reset State:	0x0004

15	14	13	12	11	10	9	8
DRIVERON	HEADPSEL		PLAYMUTE				

7	6	5	4	3	2	1	0
PLAYMUTE					MICRSEL	MCUCLKSEL	

Bit Number	Bit Mnemonic	Read/Write	Function
15	DRIVERON	R/W	If (HEADPON = 1 and DRIVERON = 0) 1. All channels muted except Headphone channels 2. Select Headphone source from Front channels Else 1. Channel mute controlled by PLAYMUTE registers 2. Headphone source selected by HEADPSEL registers
14~13	HEADPSEL	R/W	Headphone source select 00: Front channels 01: Center and Subwoofer 02: Surround channels 03: Side channels
12~3	PLAYMUTE	R/W	Channel mute control (high active) PLAYMUTE[0]: mute Left Front PLAYMUTE[1]: mute Right Front PLAYMUTE[2]: mute Center PLAYMUTE[3]: mute Subwoofer PLAYMUTE[4]: mute Left Surround PLAYMUTE[5]: mute Right Surround PLAYMUTE[6]: mute Side Left PLAYMUTE[7]: mute Side Right PLAYMUTE[8]: mute Headphone Left PLAYMUTE[9]: mute Headphone Right
2	MICRSEL	R/W	MIC right channel source select 0: left channel (mono) 1: right channel (stereo)
1~0	MCUCLKSEL	R/W	MCU clock frequency 00: 1.5Mhz 01: 3Mhz 10: 6Mhz 11: 12Mhz

REG3	Address:	0x03
	Reset State:	0x003f / 0x007f

15	14	13	12	11	10	9	8
					VRAP 25EN	MSEL1	SPDFI_ FREQ[1]

7	6	5	4	3	2	1	0
SPDFI_ FREQ[0]	PINSEL	FOE	ROE	CBOE	LOSE	HPOE	CANREC

Bit Number	Bit Mnemonic	Read/Write	Function
10	VRAP25EN	R/W	Microphone bias voltage supply select 0: 4.5V 1: 2.25V
9	MSEL1	R/W	0: MICINL/R and LIL/R mix to LOFL and LOFR 1: MICINL/R and LIL/R mix to 8 channels
8~7	SPDFI_FREQ	R	SPDIF in sample rate 00: 44.1K 01: reserved 10: 48K 11: 32K
6	PINSEL	R	0: 100 pin package 1: 48 pin package
5	FOE	R/W	1: LOFL/LOFR enable 0: LOFL/LOFR disable (Hi Z)
4	ROE	R/W	1: LOLS/LORS enable 0: LOLS/LORS disable (Hi Z)
3	CBOE	R/W	1: LOCF/LOLFE enable 0: LOCF/LOLFE disable (Hi Z)
2	LOSE	R/W	1: LOSL/LOSR enable 0: LOSL/LOSR disable (Hi Z)
1	HPOE	R/W	1: HPOUTL/HPOUTR enable 0: HPOUTL/HPOUTR disable (Hi Z)
0	CANREC	R	SPDIF in recording status 0: SPDIF in can not be recorded 1: SPDIF in can be recorded

6.2 MCU INTERFACE

CM106F+/L+ can communicate with external MCU via two-wire serial interface and act as a slave device. By this way, MCU can read four bytes from and write two bytes to USB host through CM106. When MCU writes two bytes to CM106F+/L+, the data will be transferred to USB host via HID 'Input Report'. USB host will keep polling HID report every 32ms.

CM106F+/L+ can also transfer four bytes from USB host to MCU. This is accomplished by a 'Set Output Report' HID request issued by USB host. CM106F+/L+ will then assert MINT to inform

MCU to read them.

CM106F+/L+ has one input pin 'SCLK' to get serial clock from MCU, and one open-drain output pin 'SDAT' to send or receive serial signal to/from MCU. As shown below, 'SDAT' should be stable when 'SCLK' is high, and can have transition only when 'SCLK' is low.

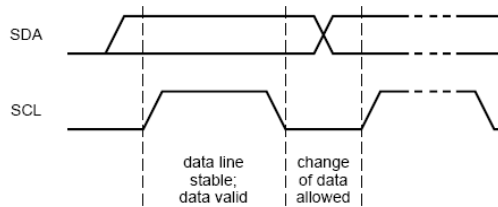

START and STOP conditions shown below are the exception. Every transaction begins from a START, and ends with a STOP, or another START (repeated START).

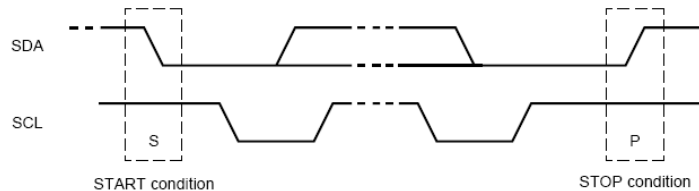

The figure below demonstrates a transaction example. After every 8 bits sent by the transmitter, the receiver should send one bit low for positive acknowledgement or one bit high for negative acknowledgement. After the negative acknowledgement, a STOP or repeated START should follow.

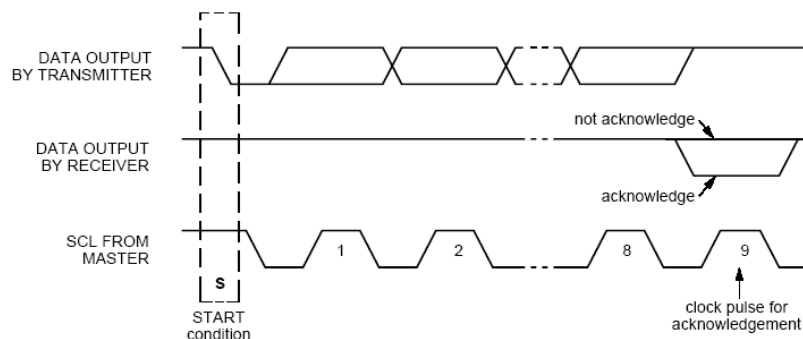

The figure below shows typical transactions between MCU and CM106. After a START, MCU should send 7-bit slave address (7'b0111000) first, and then the 8th bit denotes a read transfer when it's high; or a write transfer when it's low.

MCU write:

S	8'h70	0	8'h01	0	Byte[1]	0	Byte[2]	1	P
---	-------	---	-------	---	---------	---	---------	---	---

MCU read:

S	8'h70	0	8'h00	1							
S	8'h71	0	Byte[0]	0	Byte[1]	0	Byte[2]	0	Byte[3]	1	P

- : From CM106 to MCU
- : From MCU to CM106
- S : START condition
- P : STOP condition
- 0 : Positive acknowledge
- 1 : Negative acknowledge
- Byte : One byte data

In a write transfer, MCU keeps acting as the transmitter. CM106F+/L+ regards the first DATA byte as start register address. The second and third DATA bytes are the content that MCU writes to the register addresses.

In a read transfer, two transactions are necessary. MCU resets start register address by the first transaction. Then MCU changes to be the receiver during the second transaction to get four bytes of data.

6.3 SERIAL EEPROM CONTENT

CM106F+/L+ supports four-wire serial EEPROM interface. When an external serial EEPROM is detected, Vendor ID and Product ID reported within Device Descriptor will be derived from the content of serial EEPROM. The organization of serial EEPROM is shown below:

Address = 0	16'h630X
Address = 1	Vendor ID
Address = 2	Product ID
Address = 63	16'hXXXX

Users can program serial EEPROM via HID interface, as described in the former section. Although 64 words can be accessed by CM106F+/L+, only the first three words are significant to CM106F+/L+. The first word is a magic code. Only when it matches, CM106F+/L+ will regard the serial EEPROM valid.

6.4 DAC

CM106F+/L+ contains eight 16-bit DACs. The DACs are implemented in two-stage resistor ladder architecture. With 2X interpolator in logic block, these DACs are indeed operated at two time of sample rate. The playback stream from USB host is in signed 16-bit binary. CM106F+/L+'s logic block converts the data to unsigned format, and adds 64 as a fixed offset. The converted data to DAC input is then in unsigned 17-bit binary. The 2X interpolator, and fixed offset value added upon playback stream could improve SNR.

6.5 ADC

CM106F+/L+ contain two 16-bit ADCs. The ADCs are implemented in Sigma-Delta architecture. In addition to the default digital low pass filter, CM106F+/L+ provides an alternate one that could improve SNR further. A larger ADC input swing (4.0Vp-p) is also available. Refer to the internal register section for more information.

6.6 POWER MANAGEMENT

To meet suspend current specification of USB, CM106 F+/L+ turns off most blocks when entering suspend. The only two exception are power-on-reset and regulator.

To meet unconfigured current specification of USB, CM106 F+/L+ provides a control signal PDSW to turn off external components. PDSW would be active when USB host does not configure CM106 F+/L+. PDSW would also be active when CM106 F+/L+ is suspended. If serial EEPROM is exist, notice that it should not be powered off anyway because it contains Vendor ID and Product ID which should be returned to USB host before CM106 F+/L+ is configured.

The value of two input pin PWRSEL and PWRSEL1 (for CM106-F+ only) would affect configuration descriptor. If users declare the device as bus-power and high-power, and it is attached to a bus-power hub, USB host would not configure the device because the power budget is over.

7. SOFTWARE TECHNOLOGY

7.1 Xear 3D™ SOUND

C-Media provides new generation USB Digital Audio with exclusive Xear 3D™ sound technology. This is a value-added PC audio total solution, that integrated advance Dolby Digital and DTS sound technology. All kinds of applications can get maximum support. This patented 3D sound technology not only supports real-time 3D gaming and industry-standard 5.1CH or 7.1CH DVD, but also offers an immersive virtual 5.1Ch and 7.1CH sound field to the users regardless of what type of output device is actually utilized.

Thanks to Xear 3D™ Sound Technology, even if users are using a pair of earphones or 2CH speakers, still they can avail themselves of a much better virtual 5.1CH or 7.1CH environment capable only by Xear 3D™ Sound Technology. Better yet, all audio formats can be converted to thrilling 3-dimensional audio by this technology. Personalized and optimum 5.1CH/7.1CH listening environment and experience is thus achieved.



7.2 DOLBY® DIGITAL LIVE

C-Media Xear 3D™ Sound Solution provides another state-of-the-art high quality audio function--Dolby digital AC-3 encoder module. With this real-time software encoder, the existing and future customers who are using C-Media USB audio solution and devices can obtain this digital quality audio output by S/PDIF format much easier than before. This function can output various 3D and environmental sound effects by high quality AC-3 encoding; in the meantime, it exhibits supreme efficiency—it takes only 7% of CPU consumption from a Pentium 4 Processor.

	A technology that can encode all the digital audio content on PC into Dolby Digital stream in real-time. It can then be sent to external decoder for playback. All path are digital and wiring is simple.
---	---

Dolby® Digital Live was a real-time encoding technology it converts any audio signal into a Dolby Digital bit stream for transport and playback through a home theater system. With it, your PC or game console can be hooked up to your Dolby Digital-equipped audio/video receiver or digital speaker system via a single digital connection, eliminating the confusion of multiple cables and ensuring the integrity of the audio signal.

The real-time interactive capabilities of Dolby Digital Live technology are ideally suited to PCs and video game consoles because it reproduces audio cues and effects that follow the on-screen action, transforming game play into an exciting and realistic entertainment experience.

Systems using Dolby Digital Live technology can provide Dolby Digital (5.1-channel surround sound) during game play, immersing players in high-quality surround sound that puts them at the center of the action. Gamers hear every window shatter, feel every explosion, and experience every wipeout.

These high-performance device provide an S/PDIF connector and use a digital cable for one-step connection to a home theater system. Dolby Digital Live can also enable other future entertainment capabilities on the PC because of its ability to deliver any audio source via a single digital interface to an existing home theater system.

7.3 DTS® CONNECT

Besides Dolby, C-Media was also the world first PC audio provider whom can integrate whole DTS Digital DSP technology in software module. Everyone knows that, DTS is the famous of the world sound technology which guarantee high quality and performance. DTS Connect comprised two technology : one is DTS Interactive the other is NEO : PC.

	A real-time DTS encoder which takes any LPMC (2 channel or more) and encodes it into DTS bit stream. The data transfer format is 48 KHz at 1.5 mb/sec. Just using a single cable connection to your DTS enabled surround sound system such as, powered PC speakers, an A/V receiver or any other DTS compatible surround sound system.
---	--

DTS Interactive

A real-time DTS encoder which takes any LPMC (2 channel or more) and encodes it into DTS bit stream. The data transfer format is 48 KHz at 1.5 mb/sec. Just using a single cable connection to your DTS enabled surround sound system such as, powered PC speakers, an A/V receiver or any other DTS compatible surround sound system. It can take any content (WMA, MP3, CD, and more!) to transfer 5.1 multi-channels with real-time whenever play on line game, listen music, and watch VCD.

- Uses a single digital connection
- Transforms all PC audio signals into a DTS signal
- Optimized for low-latency interactive applications
- Provides realistic 5.1-channel surround sound effects during interactive video game play

NEO : PC

An audio up-mix matrix technology that turns any 2 channel audio into 7.1 surrounds sound. It can turn your stereo audio (WMA, MP3, CD, and more!) into a convincing multi-channel audio experience.

- Music mode allows you to control music's vocal to be concentrated or separated with center gain adjustment bar.
- Cinema mode can set to let you enjoy dramatic impact.
- Wide mode is a special effect signal to the surround channels for wide space feeling.

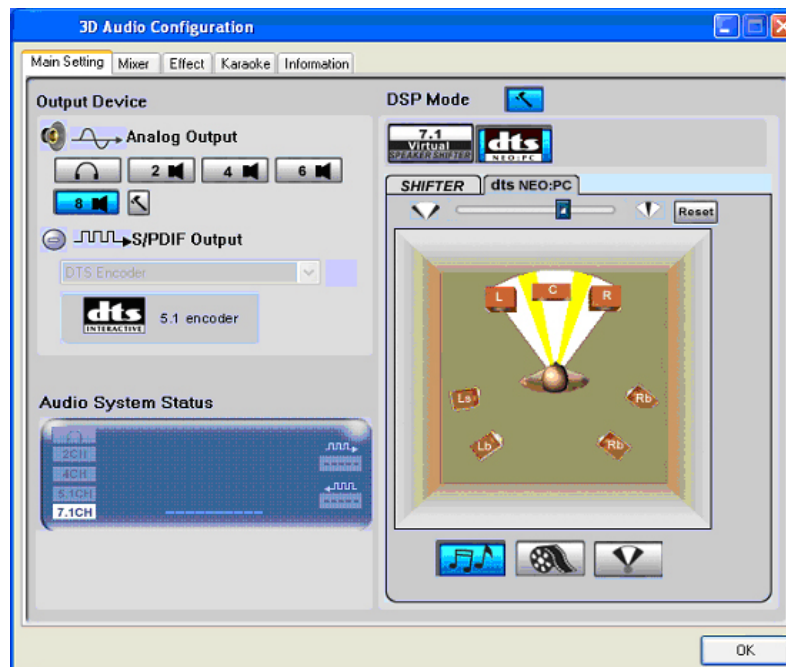
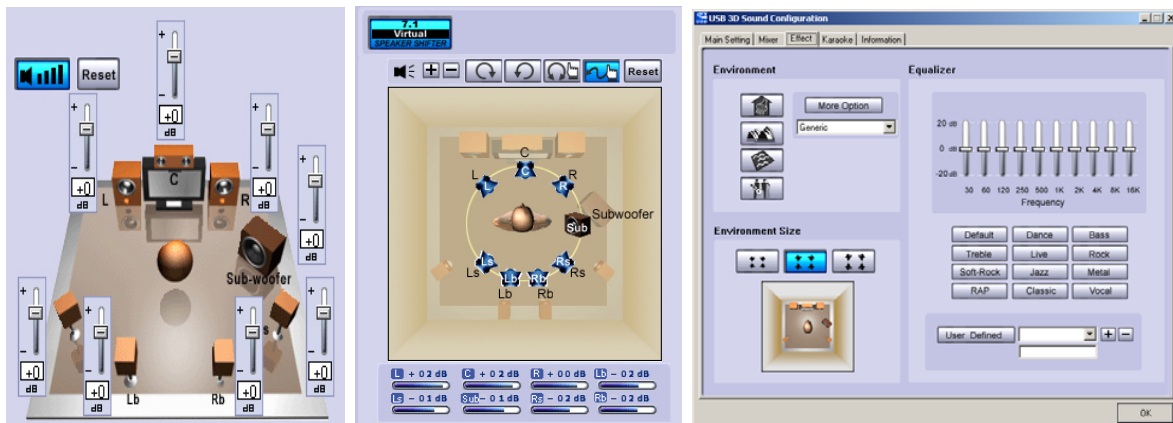

8. VOLUME CONTROL

8.1 DAC VOLUME CONTROL

VOL_*_<5:0>	Scale (linear)	VOL_*_<5:0>	Scale (linear)	VOL_*_<5:0>	Scale (linear)	VOL_*_<5:0>	Scale (linear)
00	1.000	10	0.724	20	0.448	30	0.171
01	0.973	11	0.696	21	0.420	31	0.144
02	0.944	12	0.669	22	0.392	32	0.116
03	0.917	13	0.641	23	0.365	33	0.088
04	0.890	14	0.613	24	0.337	34	0.061
05	0.862	15	0.586	25	0.309	35	0.033
06	0.834	16	0.558	26	0.282	36	0.006
07	0.807	17	0.530	27	0.254	37	mute
08	0.779	18	0.503	28	0.227		
09	0.751	19	0.475	29	0.199		

Note: VOL_*_ stands for VOL_FL_, VOL_FR_, VOL_CF_, VOL_LFE_, VOL_LS_, VOL_RS_, VOL_SL_, OL_SR_.
The volume control is in linear scale.

8.2 ADC VOLUME CONTROL

VOL_*_<3:0>	Scale (log)	VOL_*_<3:0>	Scale (log)	VOL_*_<3:0>	Scale (log)	VOL_*_<3:0>	Scale (log)
00	+22.5dB	04	+16.5dB	08	+10.5dB	12	+4.5dB
01	+21.0dB	05	+15.0dB	09	+9.0dB	13	+3.0dB
02	+19.5dB	06	+13.5dB	10	+7.5dB	14	+1.5dB
03	+18.0dB	07	+12.0dB	11	+6.0dB	15	0.0dB

Note: VOL_*_ stands for VOL_REC_L_ and VOL_REC_R_. The volume control is in log scale.

8.3 MIC / LINE-IN MONITOR VOLUME CONTROL

VOL_*_<4:0>	Scale (log)	VOL_*_<4:0>	Scale (log)	VOL_*_<4:0>	Scale (log)	VOL_*_<4:0>	Scale (log)
00	+12.0dB	08	0.0dB	16	-12.0dB	24	-24.0dB
01	+10.5dB	09	-1.5dB	17	-13.5dB	25	-25.5dB
02	+9.0dB	10	-3.0dB	18	-15.0dB	26	-27.0dB
03	+7.5dB	11	-4.5dB	19	-16.5dB	27	-28.5dB
04	+6.0dB	12	-6.0dB	20	-18.0dB	28	-30.0dB
05	+4.5dB	13	-7.5dB	21	-19.5dB	29	-31.5dB
06	+3.0dB	14	-9.0dB	22	-21.0dB	30	-33.0dB
07	+1.5dB	15	-10.5dB	23	-22.5dB	31	mute

Note: VOL_*_ stands for VOL_MICM_L_, VOL_MICM_R_, VOL_LINEM_L_, VOL_LINEM_R_. The volume control is in log scale.

9. ELECTRICAL CHARACTERISTICS

9.1 ABSOLUTE MAXIMUM RATING

Symbol	Parameter	Value	Unit
Dvmin	Min Digital Supply Voltage	- 0.3	V
Dvmax	Max Digital Supply Voltage	+ 6	V
Avmin	Min Analog Supply Voltage	- 0.3	V
Avmax	Max Analog Supply Voltage	+ 6	V
Dvinout	Voltage on any Digital Input or Output Pin	-0.3 to +5.5	V
Avinout	Voltage on any Analog Input or Output Pin	-0.3 to +5.5	V
TB _{stgB}	Storage Temperature Range	-40 to +125	°C
ESD (HBM)	ESD Human Body Mode	3500	V
ESD (MM)	ESD Machine Mode	200	V
I _{Latch_Up}	Latch Up Trigger Current	400	mA

9.2 RECOMMENDED OPERATION CONDITIONS

Operation conditions				
	Min	Typ	Max	Unit
Analog Supply Voltage	4.5	5.0	5.5	V
Digital Supply Voltage	4.5	5.0	5.5	V
Operating Current:	-	-	350	mA
Un-configure Current			80	mA
Suspend Current	-	-	250	uA
Operating ambient temperature	0	-	70	°C _{POP}

9.3 AUDIO PERFORMANCE

	Min	Typ	Max	Unit
AA Path (Line In to Line Out)				
THD + N (-3dBr)		-89		dB
Dynamic range		99		dB
Cross talk		101		dB
Frequency response 48KHz	20		20K	Hz
DAC (Front)				
THD + N (-3dBr)	-	-69	-	dB
SNR	-	92	-	dB
Dynamic range		90		dB
Frequency response @ 48KHz	20		20K	Hz
Frequency Response @ 44.1KHz	20		17.6K	Hz
Full Scale Output Voltage Range	-	1.17	-	Vrms
Center Voltage		2.25		V
Pass Band Ripple @ 48KHz			+0.05	dB
Pass Band Ripple @ 44.1KHz			+0.05	dB
DAC (Rear)				
THD + N (-3dBr)	-	-70	-	dB
SNR	-	91	-	dB
Dynamic range		90		dB
DAC (Center/Bass)				
THD + N (-3dBr)	-	-68	-	dB
SNR	-	91	-	dB
Dynamic range		90		dB
DAC (Back Surround)				
THD + N (-3dBr)	-	-68	-	dB
SNR	-	91	-	dB
Dynamic range		90		dB

	Min	Typ	Max	Unit
ADC (Line In)				
THD + N (-3dBr)		-70		dB
SNR		84		dB
Dynamic Range		85		dB
Frequency Response @ 48KHz	20		20K	Hz
Input Range	0	-	3.2 (4.0)	Vpp
ADC (Mic)				
THD + N (-3dBr)		-68		dB
SNR		83		dB
Dynamic Range		84		dB
Frequency Response @ 48KHz	70		12.5	Hz
Input Range	0	-	3.2 (4.0)	Vpp

*Note: All specifications at +25°C, AVdd=DVdd=5V, 10k Ohm loading

10. AUDIO PERFORMANCE CURVES

10.1 AA PATH (LINE IN TO LINE OUT) FREQUENCY RESPONSE

C-Media Analog Pass-Through (A-A) for Line Input to Line Output 08/12/04 10:44:41
Frequency Response

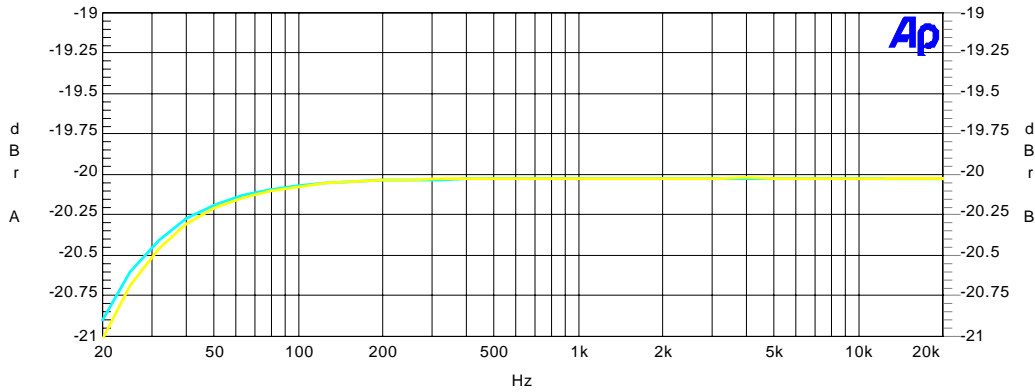

Sweep	Trace	Color	Line Style	Thick	Data	Axis	Comment
1	1	Cyan	Solid	2	Anlr.Level A	Left	
1	2	Yellow	Solid	2	Anlr.Level B	Right	

LL-FreqResp.at2

10.2 AA PATH (LINE IN TO LINE OUT) CROSS TALK

C-Media Analog to Analog Crosstalk 08/12/04 15:20:08

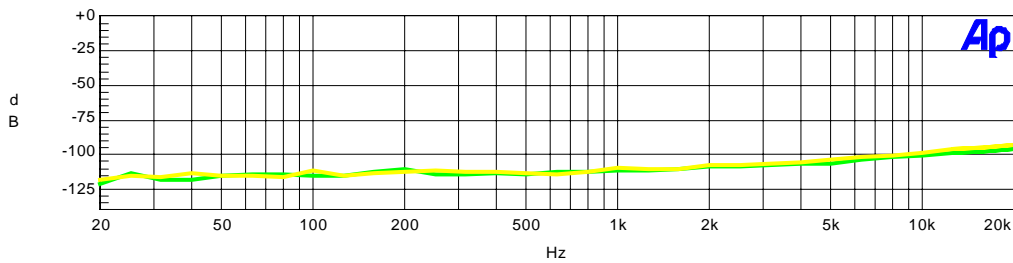

Sweep	Trace	Color	Line Style	Thick	Data	Axis	Comment
1	1	Green	Solid	3	Anlr.Crosstalk	Left	
1	2	Yellow	Solid	3	Anlr.Crosstalk	Left	

Line In to Line Out(10k ohms Load)
0dB_r = 0dBFS = 1.9 dBV

aa-axtalk.at2

10.3 DAC (FRONT) FREQUENCY RESPONSE @ 48KS/SEC

C-Media Digital Playback (PC-D-A) for Line Output Frequency Response 08/12/04 14:53:18

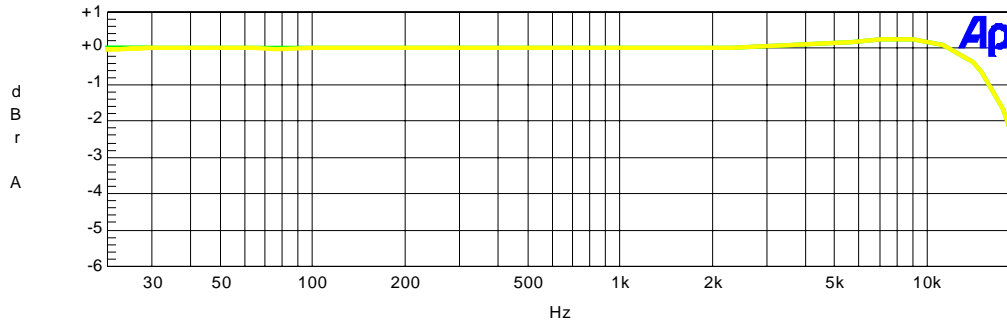

Sweep	Trace	Color	Line Style	Thick	Data	Axis	Comment
1	1	Green	Solid	3	Fasttest.Ch.1 Amp!!Normalize	Left	
1	2	Yellow	Solid	3	Fasttest.Ch.2 Amp!!Normalize	Left	

WL-Multitone-48k.at2

10.4 DAC (FRONT) FREQUENCY RESPONSE @ 44.1KS/SEC

C-Media Digital Playback (PC-D-A) for Line Output Frequency Response 08/12/04 14:54:41

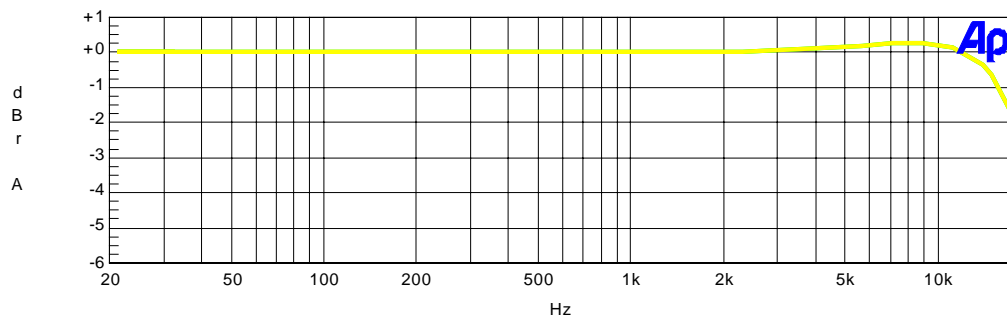

Sweep	Trace	Color	Line Style	Thick	Data	Axis	Comment
1	1	Green	Solid	3	Fasttest.Ch.1 Amp!!Normalize	Left	
1	2	Yellow	Solid	3	Fasttest.Ch.2 Amp!!Normalize	Left	

WL-Multitone-44k.at2

10.5 DAC (FRONT) PASS BAND RIPPLE @ 48KS/SEC

C-Media Digital Playback (PC-D-A) for Line Output Passband 08/12/04 14:54:00
Ripple @ 48ks/sec

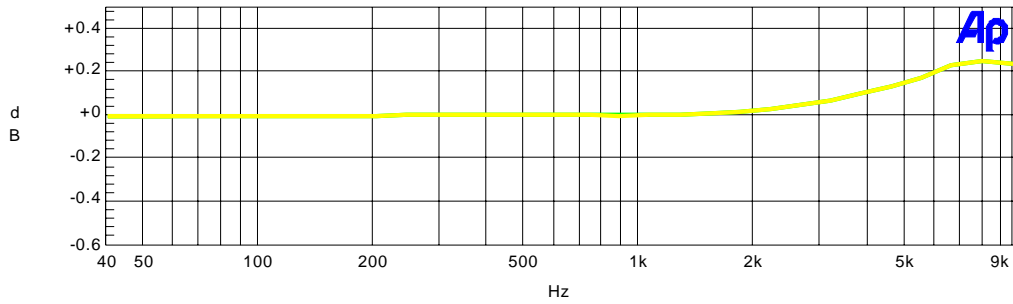

Sweep	Trace	Color	Line Style	Thick	Data	Axis	Comment
1	1	Green	Solid	3	Fasttest.Ch.1 Ampl!Normalize	Left	
1	2	Yellow	Solid	3	Fasttest.Ch.2 Ampl!Normalize	Left	

WL-PassbandRipple-M48k.at2

10.6 DAC (FRONT) PASS BAND RIPPLE @ 44.1KS/SEC

C-Media Digital Playback (PC-D-A) for Line Output Passband 08/12/04 14:55:21
Ripple @ 44.1ks/sec

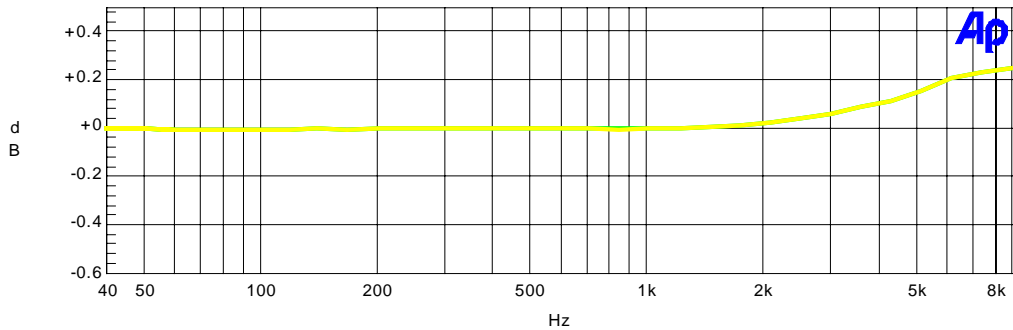

Sweep	Trace	Color	Line Style	Thick	Data	Axis	Comment
1	1	Green	Solid	3	Fasttest.Ch.1 Ampl!Normalize	Left	
1	2	Yellow	Solid	3	Fasttest.Ch.2 Ampl!Normalize	Left	

WL-PassbandRipple-M44k.at2

10.7 ADC (LINE IN) FREQUENCY RESPONSE @ 48KS/SEC

C-Media Digital Recording (A-D-PC) for Line Input Frequency Response

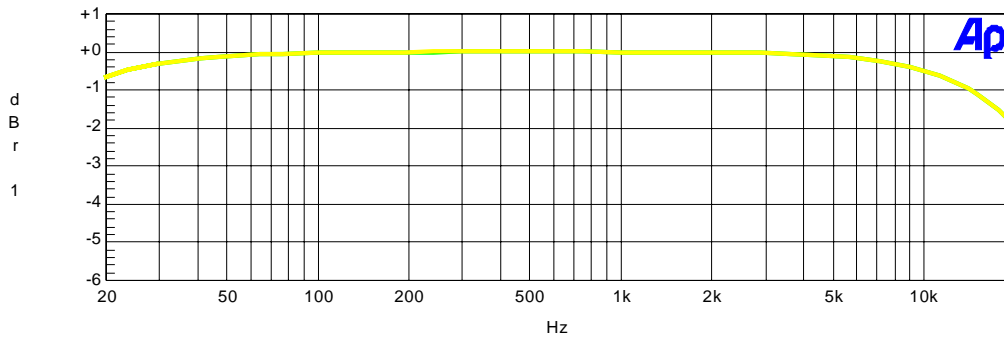

Sweep	Trace	Color	Line Style	Thick	Data	Axis	Comment
1	1	Green	Solid	3	Fasttest.Ch.1 Ampl!Normalize	Left	
1	2	Yellow	Solid	3	Fasttest.Ch.2 Ampl!Normalize	Left	

LW-MFreqResp-48K.at2

10.8 ADC (MIC IN) FREQUENCY RESPONSE @ 48KS/SEC

C-Media Digital Recording (A-D-PC) for Line Input Frequency Response

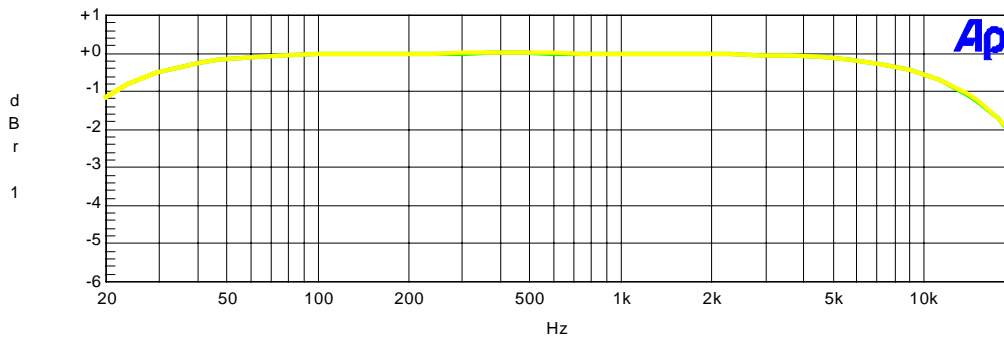

Sweep	Trace	Color	Line Style	Thick	Data	Axis	Comment
1	1	Green	Solid	3	Fasttest.Ch.1 Ampl!Normalize	Left	
1	2	Yellow	Solid	3	Fasttest.Ch.2 Ampl!Normalize	Left	

LW-MFreqResp-48K.at2

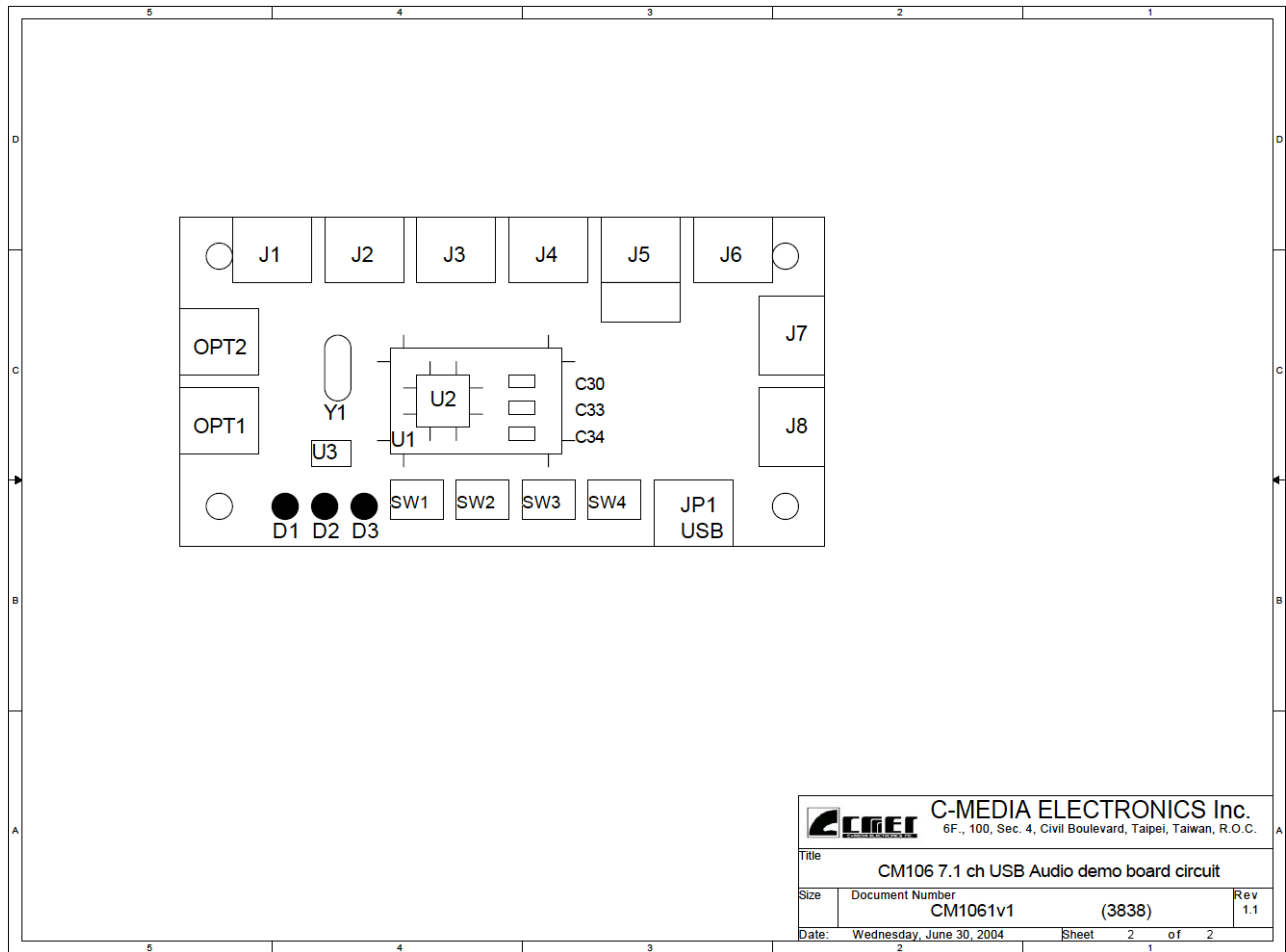

 C-MEDIA ELECTRONICS Inc. 6F., 100, Sec. 4, Civil Boulevard, Taipei, Taiwan, R.O.C.			
Title			
CM106 7.1 ch USB Audio demo board circuit			
Size	Document Number		Rev
	CM1061v1	(3838)	1.1
Date: Wednesday, June 30, 2004		Sheet	2 of 2
		2	1

REFERENCE

USB-IF, USB Specification, Revision 1.1 and 2.0, and USB Audio Device Class Specification, Revision 1.0,.

— **End of Specifications** —

C-MEDIA ELECTRONICS INC.

6F., 100, Sec. 4, Civil Boulevard, Taipei, Taiwan 106 R.O.C.

TEL:886-2-8773-1100

FAX:886-2-8773-2211

E-mail : sales@cmedia.com.tw URL : <http://www.cmedia.com.tw>