

2 Amp Source/ Sink Bus Termination Regulator

Features

- Ideal for DDR-I and DDR-II V_{TT} applications
- Sinks and sources 2.0A for DDR-I
- Over current protection
- Over temperature protection
- Integrated power MOSFETs
- Excellent accuracy (0.5% load regulation)
- Pin and functionally compatible with LP2995
- 8-lead SOIC and PSOP packages
- Lead-free versions available

Applications

- Single and Dual Channel DDR Memory Bus Termination
- Active Termination Buses
- Graphics Card Memory Termination

Product Description

The CM3106 is a sinking and sourcing regulator specifically designed for providing power to DDR memory terminating resistors and companion chip set V_{TT} power. The output voltage accurately tracks $V_{DDQ}/2$. The CM3106 can source and sink current up to 2A, ideal for DDR-I memory systems, and 1.2A for DDR-II systems, while maintaining a load regulation of 0.5% in either application.

The CM3106 provides over current and over temperature protection which protects the device from excessive heating due to high current and high temperature. A shutdown capability using an external transistor reduces power consumption and provides a high impedance output.

The CM3106 is housed in both 8-lead SOIC and PSOP packages and is available with optional lead-free finishing.

Simplified Electrical Schematic

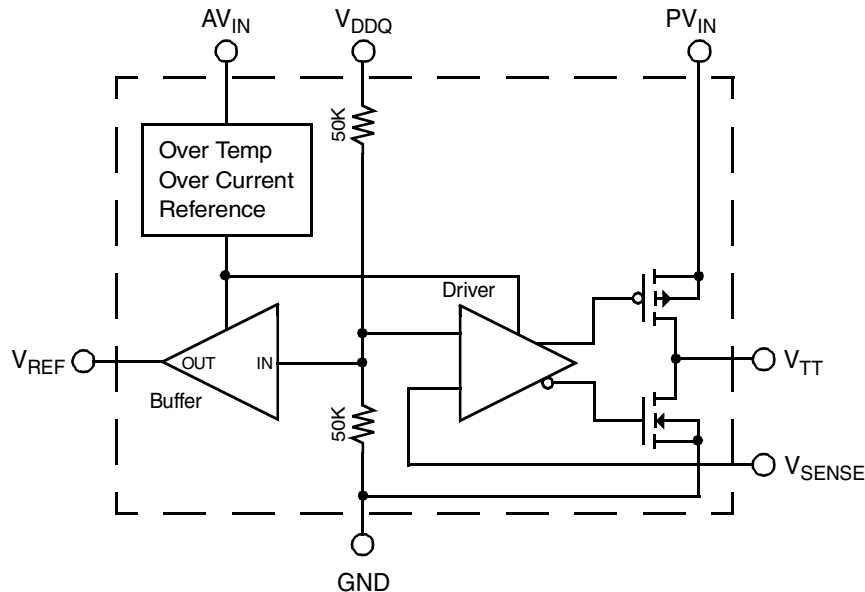

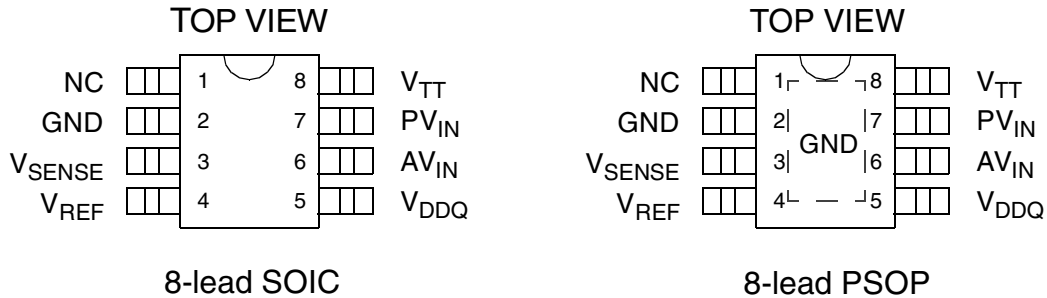
PACKAGE / PINOUT DIAGRAM

Note: This drawing is not to scale.

PIN DESCRIPTIONS

| LEAD(S) | NAME | DESCRIPTION |
|---------|--------------------|---------------------------------------|
| 1 | NC | No Connect |
| 2 | GND | Ground |
| 3 | V _{SENSE} | Feedback |
| 4 | V _{REF} | Reference Output, V _{DDQ} /2 |
| 5 | V _{DDQ} | V _{DDQ} Input |
| 6 | AV _{IN} | Analog Input |
| 7 | PV _{IN} | Power Input |
| 8 | V _{TT} | Output |

Ordering Information
PART NUMBERING INFORMATION

| Pins | Package | Standard Finish | | Lead-free Finish | |
|------|---------|-----------------------------------|--------------|-----------------------------------|--------------|
| | | Ordering Part Number ¹ | Part Marking | Ordering Part Number ¹ | Part Marking |
| 8 | SOIC-8 | CM3106-12SN | CM310601S | CM3106-12SM | CM3106-12SM |
| 8 | PSOP-8 | CM3106-12SB | CM3106-12SB | CM3106-12SH | CM3106-12SH |

Note 1: Parts are shipped in Tape & Reel form unless otherwise specified.

Specifications

| ABSOLUTE MAXIMUM RATINGS | | |
|-----------------------------------|------------------------|-------|
| PARAMETER | RATING | UNITS |
| V_{IN} Operating Supply Voltage | 7 | V |
| V_{DDQ} Input Voltage | 7 | V |
| Pin Voltages | | |
| V_{TT} Output | 7 | V |
| Any other pins | 7 | V |
| ESD (HBM) | ±2000 | V |
| Storage Temperature Range | -40 to +150 | °C |
| Operating Temperature Range | | |
| Ambient | -40 to +85 (see note1) | °C |
| Junction | -40 to +150 | °C |
| Power Dissipation (see note 1) | Internally Limited | W |

Note 1: These devices must be derated based on thermal resistance at elevated temperatures. The device packaged in a 8-lead SOIC leadframe must be derated at $\theta_{JA} = 151^{\circ}\text{C}/\text{W}$. θ_{JA} of the 8-lead PSOP is $40^{\circ}\text{C}/\text{W}$.

| STANDARD OPERATING CONDITIONS | | |
|-------------------------------|----------|-------|
| PARAMETER | VALUE | UNITS |
| V_{DDQ} | 2.5 | V |
| V_{IN} | 2.5 | V |
| PV_{IN} | 2.5 | V |
| Ambient Operating Temperature | 0 to +70 | °C |
| C_{TT} | 220 ±20% | µF |

| ELECTRICAL OPERATING CHARACTERISTICS (SEE NOTE 1) | | | | | | |
|---|------------------------------|---|-------|------|----------|-------|
| SYMBOL | PARAMETER | CONDITIONS | MIN | TYP | MAX | UNITS |
| V_{IN} | Input Voltage Range | | 2.2 | 2.5 | V_{IN} | V |
| | | | 2.2 | 2.5 | 5.5 | V |
| I_{CC} | V_{IN} Quiescent Current | $I_{VTT} = 0\text{A}$ | | 450 | | µA |
| V_{RLOAD} | Load Regulation | $0\text{A} \leq I_{VTT} \leq 2.0\text{A}$ or $-2.0\text{A} \leq I_{VTT} \leq 0\text{A}$ | | 6.25 | | mV |
| V_{REF} | Output Reference Voltage | $V_{DDQ}=2.5\text{V}$, $I_{REF}=0\text{A}$ | 1.225 | 1.25 | 1.275 | V |
| V_{OSVTT} | Output Offset from V_{REF} | | -20 | | 20 | mV |
| Z_{REF} | V_{REF} Output Impedance | $-5\mu\text{A} \leq I_{REF} \leq 5\mu\text{A}$ | | 5 | | kΩ |
| Z_{VDDQ} | V_{DDQ} Input Impedance | | | 100 | | kΩ |
| I_{LIM} | V_{TT} Current Limit | | | 2.5 | | A |
| $T_{DISABLE}$ | Shutdown Temperature | | | 150 | | °C |
| T_{HYST} | Thermal Hysteresis | | | 50 | | °C |

Note 1: Operating Characteristics are over Standard Operating Conditions unless otherwise specified.

Performance Information

Typical DC Characteristics (nominal conditions unless otherwise specified)

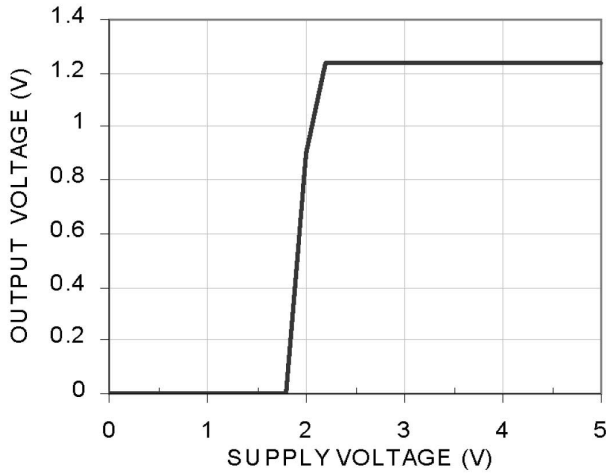

Figure 1. Output Voltage with AV_{IN} Supply ($V_{DDQ}=2.5V$)

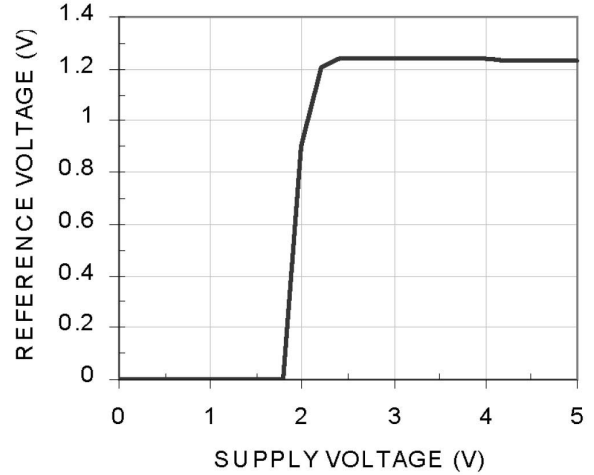

Figure 3. Reference Voltage with AV_{IN} Supply ($V_{DDQ}=2.5V$)

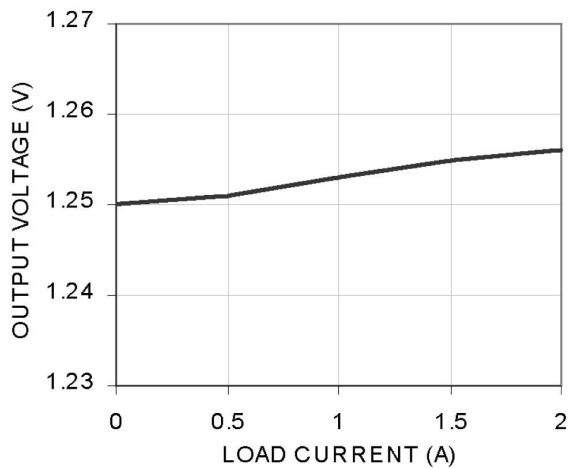

Figure 2. Load Regulation (Sink)

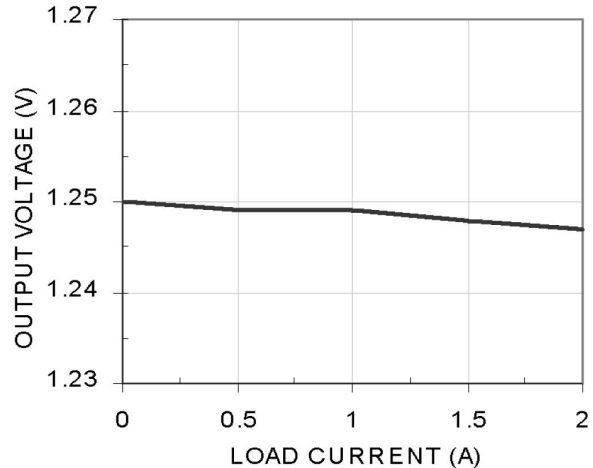

Figure 4. Load Regulation (Source)

Performance Information (cont'd)

Typical DC Characteristics (nominal conditions unless otherwise specified)

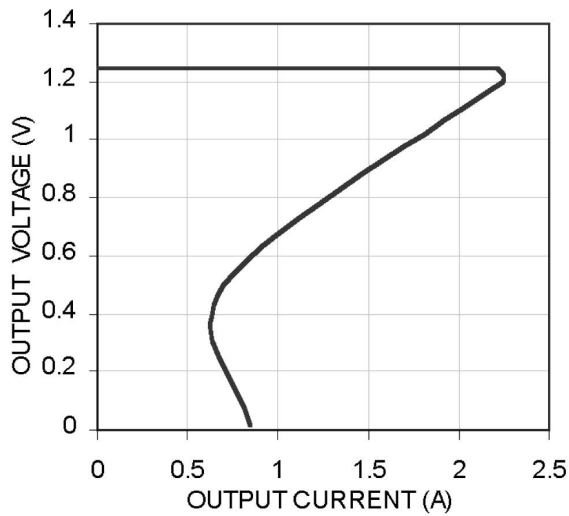

Figure 5. Over Current Limit (Sink)

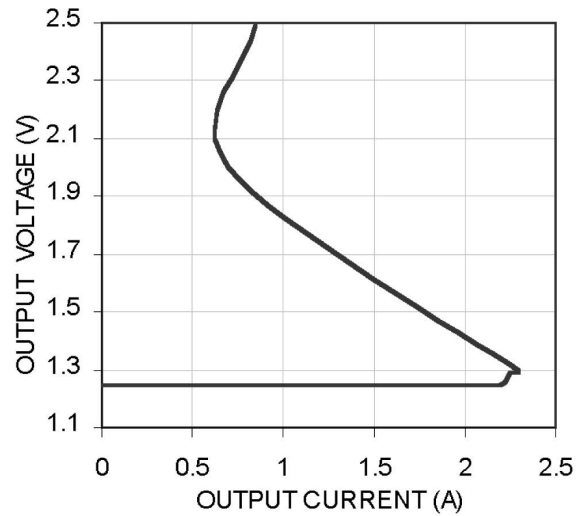

Figure 7. Over Current Limit (Source)

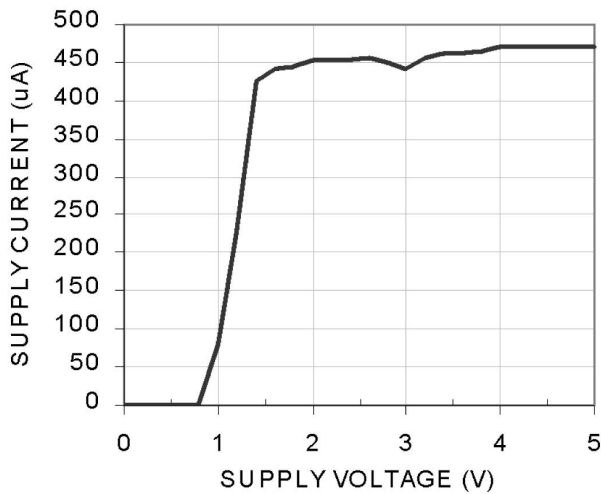
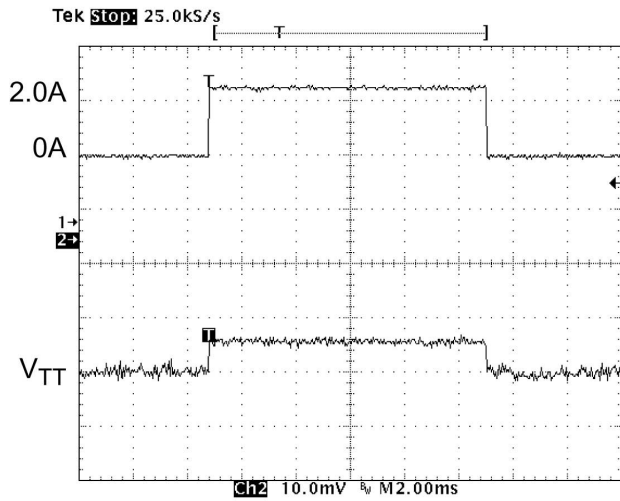

Figure 6. AV_{IN} Supply Current with Supply Voltage

Performance Information (cont'd)

Typical Transient Characteristics (nominal conditions unless otherwise specified)



**Figure 8. Load Transient
(0A to 2.0A Sink)**

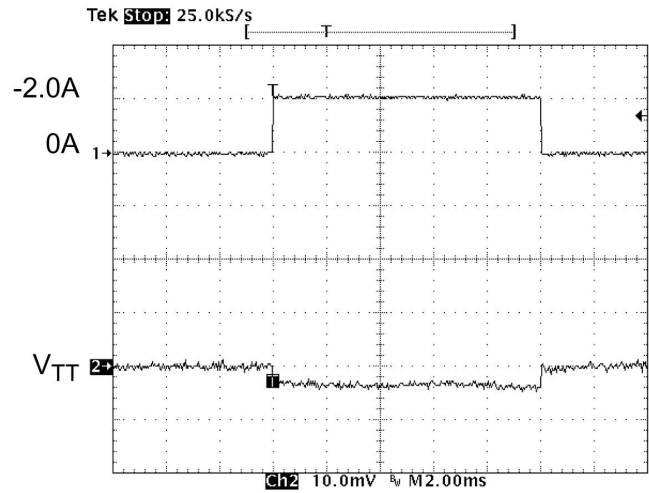

**Figure 9. Line Transient
(0A to 2.0A Source)**

Performance Information (cont'd)

Typical Thermal Characteristics (nominal conditions unless otherwise specified)

The overall junction to ambient thermal resistance (θ_{JA}) for device power dissipation (P_D) consists primarily of two paths in series. The first path is the junction to the case (θ_{JC}) which is defined by the package style, and the second path is case to ambient (θ_{CA}) thermal resistance which is dependent on board layout. The final operating junction temperature for any set of conditions can be estimated by the following thermal equation:

$$T_{JUNC} = T_{AMB} + P_D (\theta_{JC}) + P_D (\theta_{CA})$$

$$= T_{AMB} + P_D (\theta_{JA})$$

When a CM3106-12SN is mounted on a double sided printed circuit board with two square inches of copper allocated for "heat spreading", the resulting θ_{JA} is 151°C/W. Based on the over temperature limit of 150°C with an ambient of 70°C, the available power of this package will be:

$$P_D = (150^\circ\text{C} - 85^\circ\text{C}) / 151^\circ\text{C/W} = 0.43\text{W}$$

Since the θ_{JA} of the CM3106-12SB (PSOP) is 40°C/W, the available power for this package will be:

$$P_D = (150^\circ\text{C} - 85^\circ\text{C}) / 40^\circ\text{C/W} = 1.625\text{W}$$

DDR Memory Application

Since the output voltage is 1.25V, and the device can either source current from V_{DD} or sink current to Ground, the power dissipated in the device at any time is 1.25V times the current load. This means the the maximum average RMS current (in either direction) is 0.344A for the CM3106-12SN and 1.3A for the CM3106-12SB. The maximum instantaneous current is specified at 2A, so this condition should not be exceeded for more than 17% of the time for the CM3106-12SN and 65% of the time for the CM3106-12SB. It is highly unlikely in most usage of DDR memory that this might occur, because it means the DDR memory outputs are either all high or all low for 17% (SOIC) and 65% (PSOP) of the time.

If the ambient temperature is 40°C instead of 85°C, which is typically the maximum in most DDR memory applications, the power dissipated (P_D) can be 0.73W, for the CM3106-12SN and 2.75W for the CM3106-12SB. So the maximum average RMS current

increases from 0.42A to 0.58A for the CM3106-12SN and a maximum instantaneous current of 2A should not be exceeded for more than 29% of the time. For CM3106-12SB, the maximum RMS current increases from 1.3A to 2.2A. Thus, the maximum continuous current can be 2A all the time.

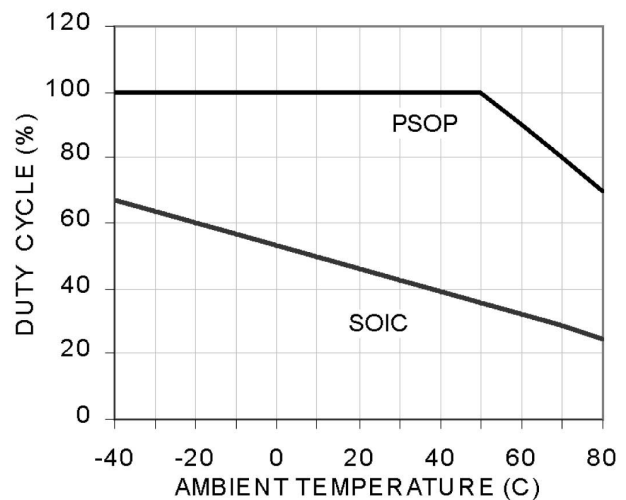

Figure 10. Duty Cycle vs. Ambient Temperature (I_LOAD=2.0A)

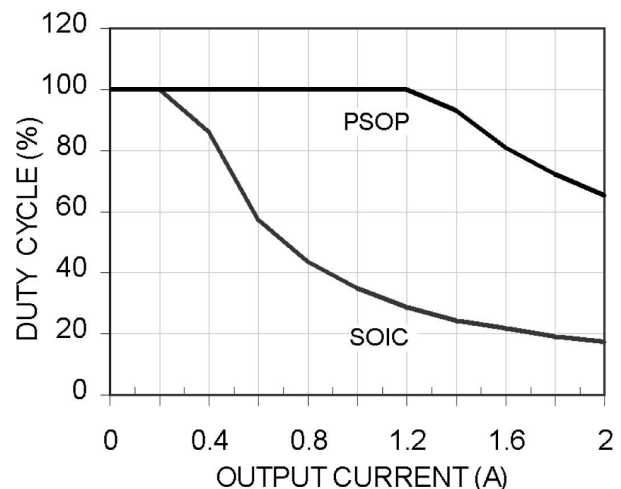

Figure 11. Duty Cycle vs. Output Current (Temp=70°C)

Performance Information (cont'd)

Typical Thermal Characteristics (cont'd) (nominal conditions unless otherwise specified)

The theoretical calculations of these relationships show the safe operating area of the CM3106 in the SOIC package.

Thermal characteristics were measured using a double sided board with two square inches of copper area connected to the GND pins for "heat spreading".

Measurements showing performance up to a junction temperature of 150°C were performed under light load conditions (5mA). This allows the ambient temperature to be representative of the internal junction temperature.

Note: The use of multi-layer board construction with separate ground and power planes will further enhance the overall thermal performance.

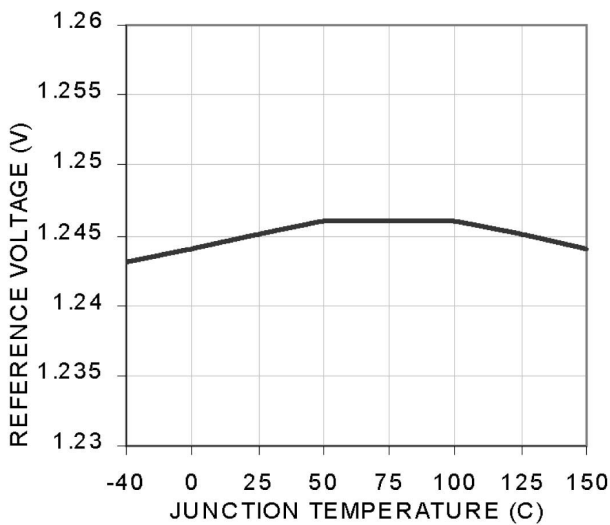

Figure 12. Reference Voltage vs. Temperature

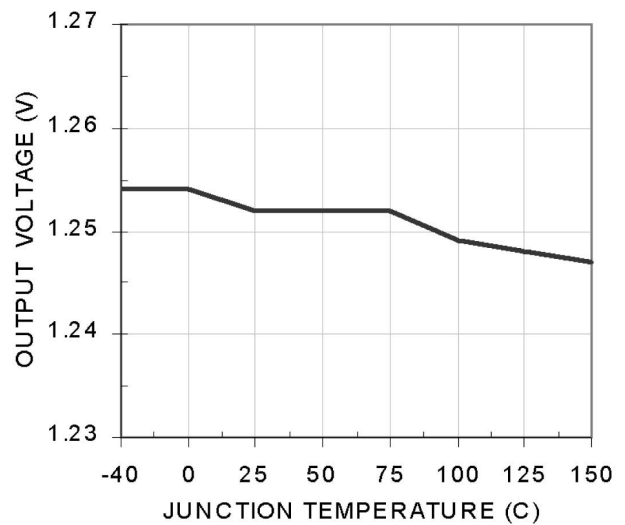

Figure 13. V_{TT} Output Voltage vs. Temperature (5mA load)

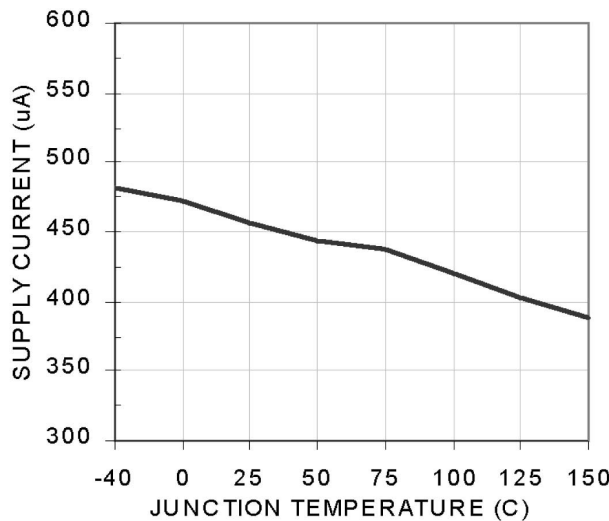

Figure 14. AV_{IN} Quiescent Current vs. Temperature

Application Information

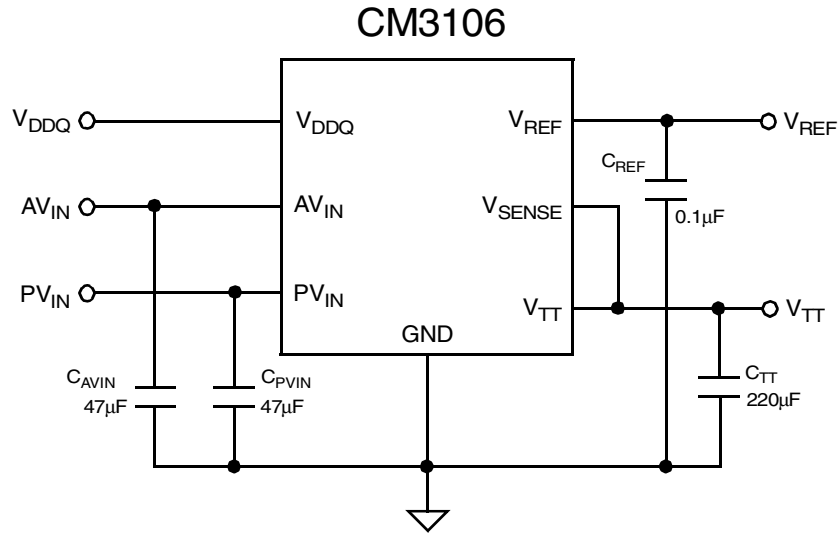

Figure 15. Typical Application Circuit

PCB Layout Considerations

The CM3106-12SB has a heat spreader attached to the underneath of the PSOP-8 package in order for heat to be transferred much easier from the package to the PCB. The heat spreader is a copper pad of dimensions just smaller than the package itself. By positioning the matching pad on the PCB top layer to connect to the spreader during manufacturing, the heat will be transferred between the two pads. The drawing below shows the recommended PCB layout. Note that there are six vias on either side to allow the heat to dissipate into the ground and power planes on the inner layers of

the PCB. Vias can be placed underneath the chip, but this can cause blockage of the solder. The ground and power planes should be at least 2 sq in. of copper by the vias. It also helps dissipation to spread if the chip is positioned away from the edge of the PCB, and not near other heat dissipating devices. A good thermal link from the PCB pad to the rest of the PCB will ensure a thermal link from the CM3106 package to ambient, θ_{JA} , of around 40°C/W.

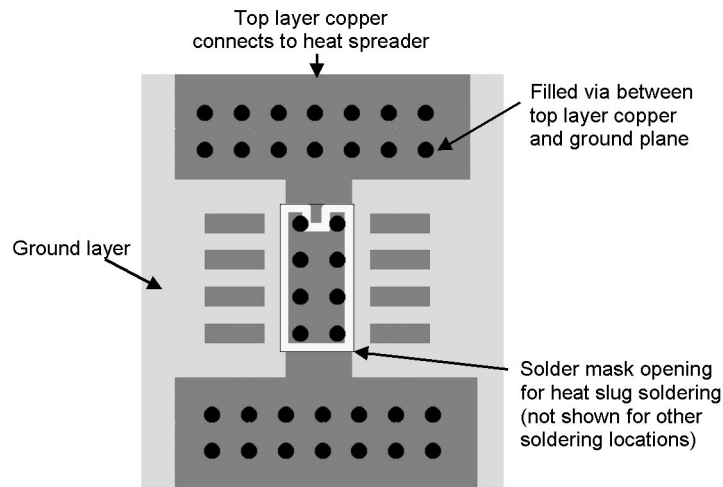

Figure 16. Recommended Heat Sink PCB Layout

Mechanical Details

The CM3106 is available in an 8-lead SOIC and PSOP package.

SOIC-8 Mechanical Specifications

Dimensions for CM3106 devices packaged in 8-pin SOIC packages are presented below.

For complete information on the SOIC-8 package, see the California Micro Devices SOIC Package Information document.

| PACKAGE DIMENSIONS | | | | |
|-------------------------------|-------------|------|-----------|-------|
| Package | SOIC | | | |
| Leads | 8 | | | |
| Dimensions | Millimeters | | Inches | |
| | Min | Max | Min | Max |
| A | 1.35 | 1.75 | 0.053 | 0.069 |
| A ₁ | 0.10 | 0.25 | 0.004 | 0.010 |
| B | 0.33 | 0.51 | 0.013 | 0.020 |
| C | 0.19 | 0.25 | 0.007 | 0.010 |
| D | 4.80 | 5.00 | 0.189 | 0.197 |
| E | 3.80 | 4.19 | 0.150 | 0.165 |
| e | 1.27 BSC | | 0.050 BSC | |
| H | 5.80 | 6.20 | 0.228 | 0.244 |
| L | 0.40 | 1.27 | 0.016 | 0.050 |
| # per tube | 100 pieces* | | | |
| # per tape and reel | 2500 pieces | | | |
| Controlling dimension: inches | | | | |

* This is an approximate number which may vary.

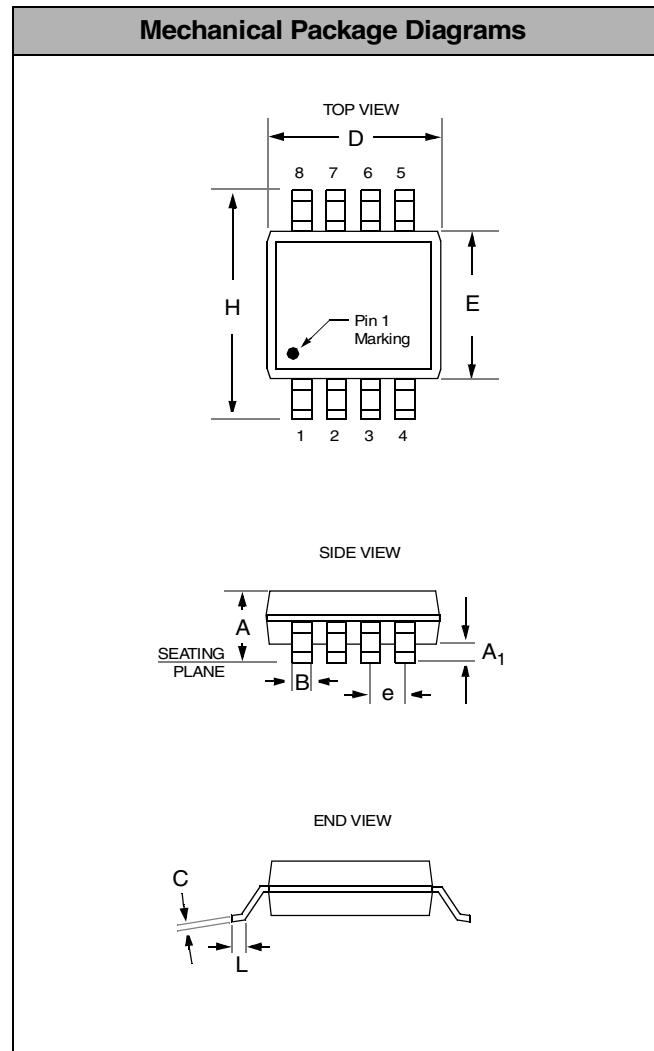

Package Dimensions for SOIC-8

Mechanical Details

PSOP-8 Mechanical Specifications

Dimensions for CM3106 devices packaged in 8-pin PSOP packages with an integrated heatslug are presented below.

| PACKAGE DIMENSIONS | | | | |
|-------------------------------|-------------|------|--------|-------|
| Package | PSOP-8 | | | |
| Leads | 8 | | | |
| Dimensions | Millimeters | | Inches | |
| | Min | Max | Min | Max |
| A | 1.30 | 1.62 | 0.051 | 0.064 |
| A ₁ | 0.03 | 0.10 | 0.001 | 0.004 |
| B | 0.33 | 0.51 | 0.013 | 0.020 |
| C | 0.18 | 0.25 | 0.007 | 0.010 |
| D | 4.83 | 5.00 | 0.190 | 0.197 |
| E | 3.81 | 3.99 | 0.150 | 0.157 |
| e | 1.02 | 1.52 | 0.040 | 0.060 |
| H | 5.79 | 6.20 | 0.228 | 0.244 |
| L | 0.41 | 1.27 | 0.016 | 0.050 |
| x** | 3.30 | 3.81 | 0.130 | 0.150 |
| y** | 2.29 | 2.79 | 0.090 | 0.110 |
| # per tube | 100 pieces* | | | |
| # per tape and reel | 2500 pieces | | | |
| Controlling dimension: inches | | | | |

* This is an approximate number which may vary.

** Centered on package centerline.

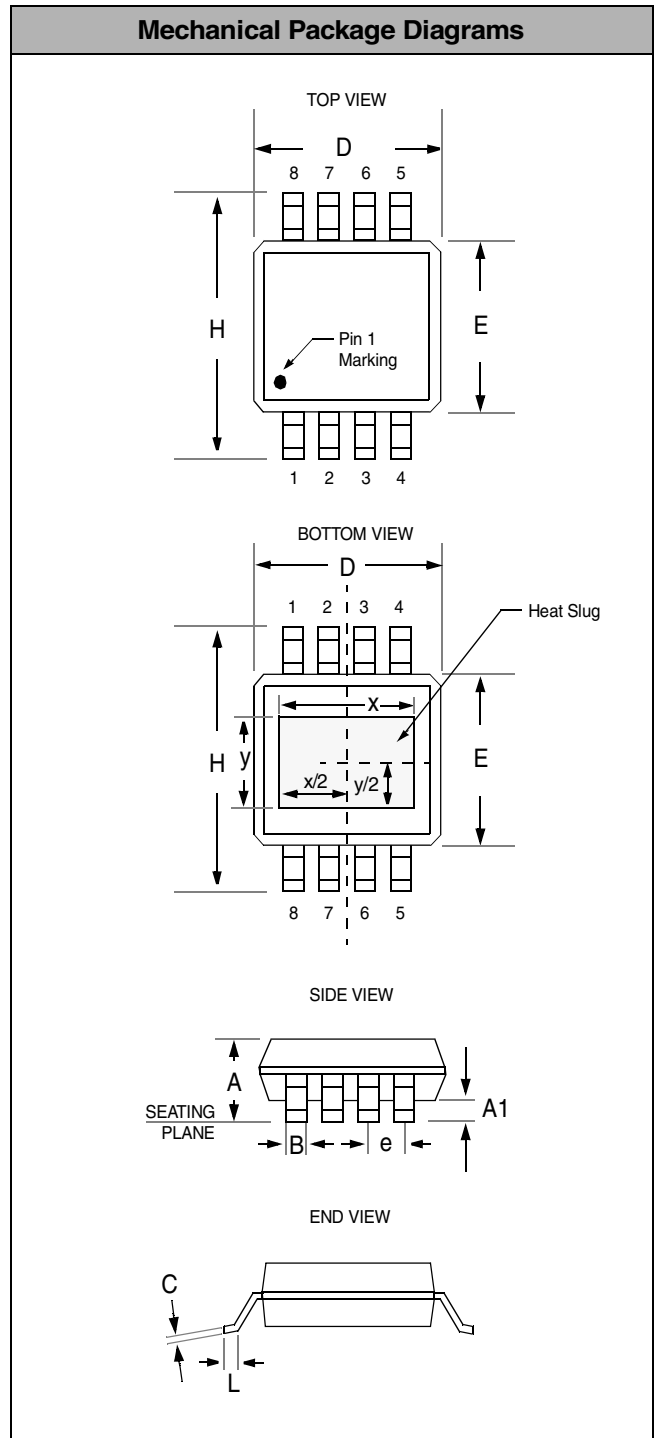

Package Dimensions for PSOP-8