

SPECIFICATION FOR APPROVAL

REF :

PAGE: 1

PROD. NAME	WOUND CHIP INDUCTOR	ABC'S DWG NO.	CC2520□□□□3□-□□□
		ABC'S ITEM NO.	

. CONFIGURATION & DIMENSIONS :

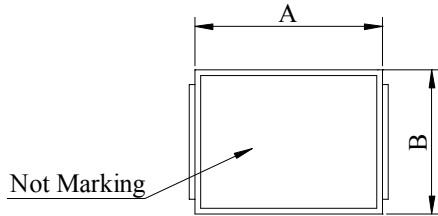

- A : 2.5±0.2 m/m
- B : 2.0±0.1 m/m
- C : 1.8±0.1 m/m
- E : 1.4±0.1 m/m
- F : 0.40 m/m

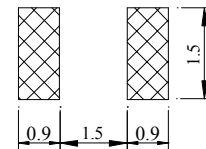
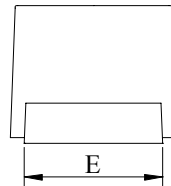
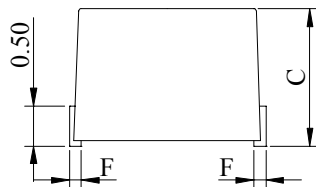

(PCB Pattern)

. SCHEMATIC DIAGRAM :



. MATERIALS :

- a . Core : Ferrite DR core
- b . Wire : Enamelled copper wire
- c . Terminal : Cu/Sn
- d . Encapsulate : Epoxy novolac molding compound
- e . Remark : Products comply with RoHS' requirements

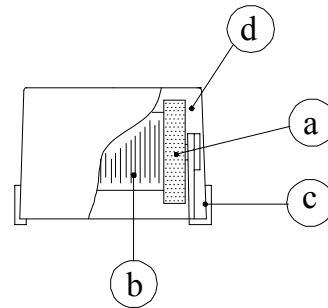

. GENERAL SPECIFICATION :

- a . Temp. rise : 20 max.
- b . Ambient temp. : 80 max.
- c . Storage temp. : -40 ----+100
- d . Operating temp. : -40 ----+85
- e . Terminal strength : 0.5 kg min.
- f . Rated current : Current cause inductance drop within 10%
- g . Resistance to solder heat : 260 .10 secs.
- h . Resistance to solvent : Per MIL-STD-202F

Peak Temp : 245 max.
 Max time above 225 : 30sec max.
 Max time above 200 : 50sec max.

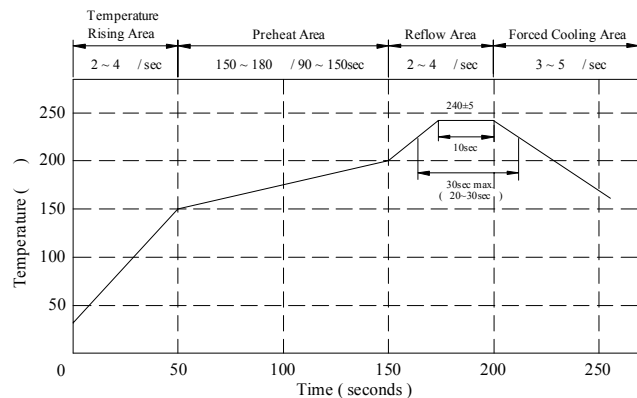

AR-001A

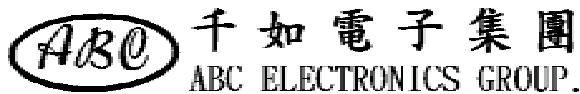

SPECIFICATION FOR APPROVAL

REF :

PAGE: 2

PROD. NAME	WOUND CHIP INDUCTOR	ABC'S DWG NO.	CC2520□□□□3□-□□□
		ABC'S ITEM NO.	

. ELECTRICAL CHARACTERISTICS :

DWG No.	Inductance (μH)	Q typ.	Test Freq (MHz)	SRF (MHz) min.	RDC (Ω) ±30%	IDC (mA) max.
CC25201R0M3□-□□□	1.0±20%	20	7.96	200	0.34	475
CC25201R5M3□-□□□	1.5±20%	20	7.96	165	0.42	435
CC25202R2M3□-□□□	2.2±20%	20	7.96	95	0.50	390
CC25203R3M3□-□□□	3.3±20%	20	7.96	55	0.65	340
CC25204R7M3□-□□□	4.7±20%	20	7.96	43	0.80	285
CC25206R8M3□-□□□	6.8±20%	20	7.96	39	1.00	275
CC2520100K3□-□□□	10.0±10%	30	2.52	32	1.69	210
CC2520150K3□-□□□	15.0±10%	30	2.52	21	2.20	175
CC2520220K3□-□□□	22.0±10%	30	2.52	18	2.80	160
CC2520330K3□-□□□	33.0±10%	30	2.52	16	4.20	120

1) . □ : Packaging information... A : Bulk B : Taping Reel

2) . "- □□□ " : Reference code

AR-001A



千如電子集團
ABC ELECTRONICS GROUP.

SPECIFICATION FOR APPROVAL

REF :

PAGE: 3

PROD. NAME	WOUND CHIP INDUCTOR	ABC'S DWG NO.	CC2520□□□□3□-□□□
		ABC'S ITEM NO.	

. PACKAGING INFORMATION :

(1) Configuration

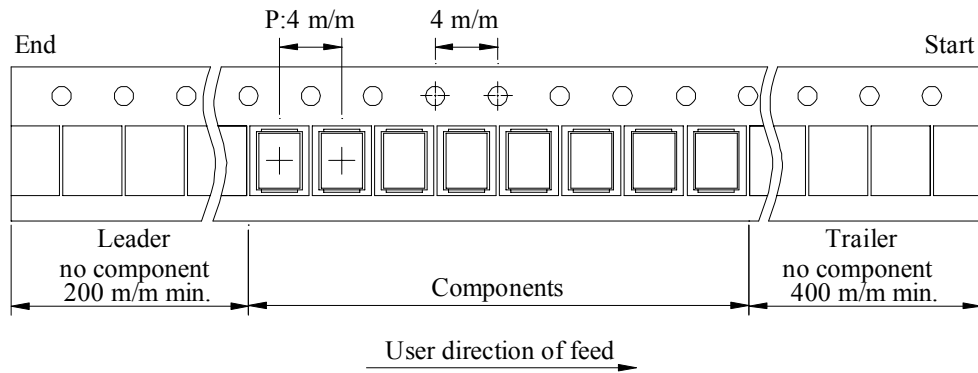
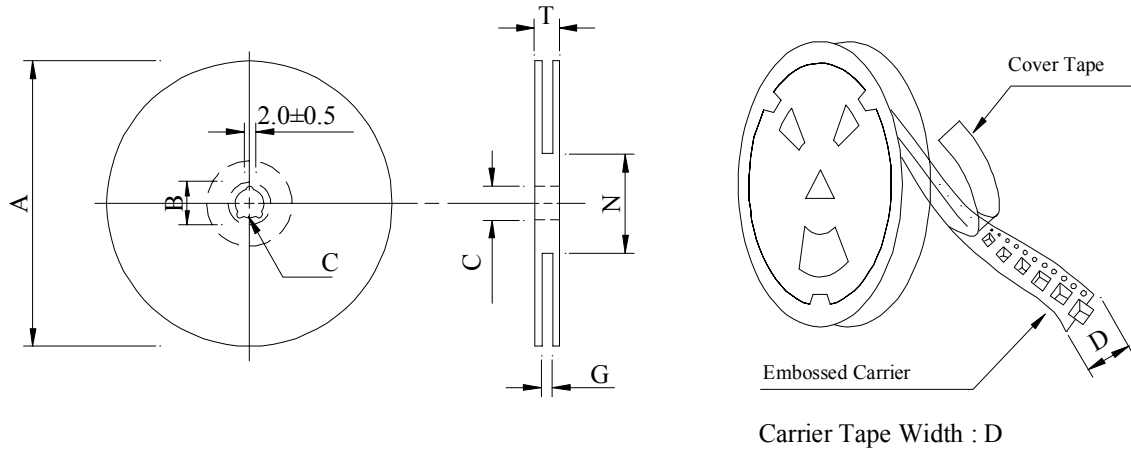

(2) Dimensions

Unit:m/m

Style	A	B	C	D	G	N	T
07 - 08	178	21±0.8	13	8	10 ⁺⁰	50 ⁻⁰	12.5

(3) Q'TY & G.W. Per package

Series	Inner : Reel			Outer : Carton		
	Q'TY (pcs)	G.W. (gw)	Style	Q'TY (pcs)	G.W. (Kg)	Size (cm)
CC2520	2,000	60	07 - 08	100,000	5.0	41 x 39 x 22

AR-001A



SPECIFICATION FOR APPROVAL

REF :

PAGE: 4

PROD. NAME	WOUND CHIP INDUCTOR	ABC'S DWG NO.	CC2520□□□□3□-□□□
		ABC'S ITEM NO.	

. DWGING NUMBER EXPRESSION :

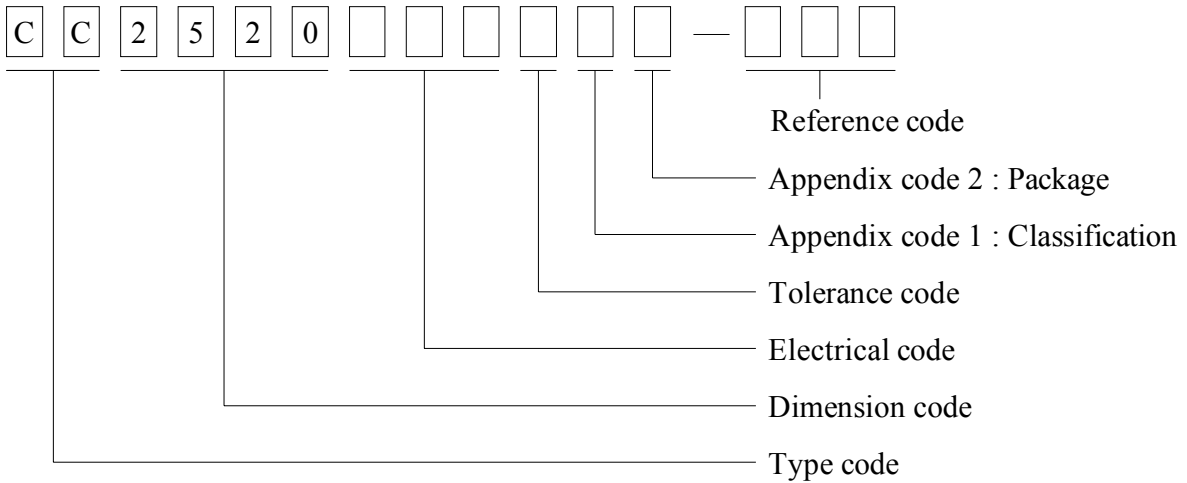

Appendix code 1 : Product Classification

- L : Lead Free Standard products comply with RoHS' requirements
- 1 ~ 9 : Lead Free Special products comply with RoHS' requirements

Appendix code 2 : Package Information

Code	Inner package	Inner package Q'TY	Remark
A	T.B.D.	T.B.D.	
B	T / R (Reel package)	2000 pcs	

AR-001A

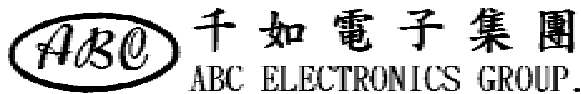

SPECIFICATION FOR APPROVAL

REF :

PAGE: 5

PROD. NAME	WOUND CHIP INDUCTOR	ABC'S DWG NO.	CC2520□□□□3□-□□□
		ABC'S ITEM NO.	
. RELIABILITY TEST :			
Test item	Specification	Test condition / Test method	
● Electrical performance test			
Inductance L	Refer to standard electrical characteristic list	□HP4194A with HP-16034E test fixture	
Q			
Self resonance frequency SRF		□HP4291A with HP-16093A test fixture	
DC Resistance RDC		CH-502AC	
Rated current IDC		Applied the current to coils , The Inductance change shall be less than 10% to initial value & temperature rise shall not be more than 20	
Temperature rise test	20 max.	1 . Applied the allowed DC current for 10 minutes 2 . Temperature measure by digital surface thermometer	
Over load test	After test , Inductors shall be no evidence of electrical and mechanical damage	Applied 2 times of rated allowed DC current to inductor for a period of 5 minutes	
Withstanding voltage test	After tset , Inductors shall be no evidence of electrical and mechanical damage	AC voltage of 1000VAC applied between inductors terminal and coating for 5 seconds	
Insulation resistance test	1000 MΩ min .	100 VDC applied between inductor terminal and coating	
● Mechanical performance test			
Vibration test (Low frequency)	1 . Inductors shall be no evidence of electrical and mechanical damage	1 . Amplitude : 1.5 m/m 2 . Frequency : 10 -- 55 -- 10 Hz / 1min. 3 . Direction : X , Y , Z 4 . Duration : 2 hrs / X , Y , Z	
Shock test	2 . Inductance shall not change more than±5%	Inductors shall be dropped 10 times from a height of 1m onto 3cm wooden board	
Resistance to soldering heat	3 . Q Shall not change more than ±20%	Temp : 260±5 Time : 10±1.0 sec.	

AR-001A



SPECIFICATION FOR APPROVAL

REF :

PAGE: 6

PROD. NAME	WOUND CHIP INDUCTOR	ABC'S DWG NO.	CC2520□□□□3□-□□□
		ABC'S ITEM NO.	
Terminal strength-pull test	Terminal shall not be loosened or ruptured	A 0.5kg load shall be applied to both Terminals in the axis direction for 1 minute .	
Solderability test	The terminal shall be at least 90% covered with solder	After fluxing , Inductor shall be dipped in a melted solder bath at 230±5 for 5 seconds .	
Resistance to solvent test	There shall be no case deformation change in appearance or obliteration of marking	MIL-STD-202F , Method 215D	
● Climatic test			
Temperature characteristic	1 . Inductors shall be no evidence of electrical and mechanical damage 2 . Inductance shall not change more than ±10% 3 . Q shall not change more than ±20%	-25 -- 85	
Humidity test		1 . Temp : 40±2 2 . R.H. : 90 -- 95% 3 . Time : 96±2 hours	
Cold test		1 . Temp : -25±2 2 . Time : 96±2 hours	
Thermal shock test		<p style="text-align: center;">Total : 5 cycles</p>	
Dry heat test		1 . Temp : 85±2 2 . Time : 96±2 hours	
High temperature load life test	There shall be no evidence of short or open circuiting	1 . Temp : 85±2 2 . Time : 1000±12 hours 3 . Load : Allowed DC current	
Humidity load life		1 . Temp : 40±2 2 . R.H. : 90 -- 95% 3 . Time : 1000±12 hours 4 . Load : Allowed DC current	
● Note : Unless otherwise specified , Allow the specimen to stand at room temperature for 1 hour or more but not more than 2 hours , Measure the electrical and mechanical performances			

AR-001A



SPECIFICATION FOR APPROVAL

REF :

PAGE: 7

PROD. NAME	WOUND CHIP INDUCTOR	ABC'S DWG NO.	CC2520□□□□3□-□□□
		ABC'S ITEM NO.	

UL CARD :

OBMW2 September 8, 2000
Magnet Wire-Component
JUNG SHING WIRE CO LTD E174837
231 CHUNG CHENG RD, SEC 3 JEN-TEH HSIANG, TAINAN
HSIEN TAIWAN

Mtl Dsg	Mark Dsg	BC	Coat Typ	OC	ANSI Type	Temp Class
AIW	---	Polyamideimide	---	---	MW81-C	220
CFUEWB	---	Polyurethane	---	---	MW75C	130
EIAIW	---	Polyesterimide	Polyamideimide	---	MW35C	200
EILOCKY	---	Polyesterimide	Polyamide	---	---	180
EILOCKW	---	Polyesterimide	Modified Epoxy	---	---	200
EIW	---	Polyesterimide	---	---	---	220
EIW-2	---	Polyesterimide	---	---	MW74-C	200
FL.EILOCKY	---	Modified Polyester	Polyamide	---	---	155
LSFFW	---	Polyurethane	---	---	MW79-C	155
LSUEW	---	Polyurethane	---	---	---	130
PEW	---	Polyester	---	---	---	155
PEY	---	Polyester	Nylon	---	MW24-C	155
SF.FLW	---	Modified Polyester	---	---	MW26C	155
SF.EIW	---	Polyesterimide	---	---	MW77C	180
SF.BY@	---	Modified Polyester	Nylon	---	MW27-C	155
SF.FLY@	---	Modified Polyester	Nylon	---	MW27-C	155
SF.BLOCKBS	---	Modified Polyester	Modified Polyamide	---	---	155
SF.EILOCKY#	---	Polyesterimide	Polyamide	---	---	180
SF.EILOCKBS	---	Polyesterimide	Modified Polyamide	---	---	180
SF.BW@	---	Modified Polyester	Polyamide	---	MW26C	155
SFFW	---	Polyurethane	---	---	MW79	155

287806002 Page 1 of 2

A not-for-profit organization dedicated to public safety and committed to quality service

Mtl Dsg	Mark Dsg	BC	Coat Typ	OC	ANSI Type	Temp Class
SFFY	---	Polyurethane	Polyamide	---	MW80C	155
UEW-1	---	Polyurethane	---	---	MW2-C	105
UEW-2	---	Polyurethane	---	---	---	130
UEW-4	---	Polyurethane	---	---	MW75C	130
UEY	---	Polyurethane	Nylon	---	MW28-C	130
UEY-2	---	Polyurethane	Polyamide	---	MW28-C	130

@-May be suffixed by LZ; # - May be suffixed by LZ, EL or LZI.
LZ - Signifies magnd wires twisted together; EL - signifies base coated magnet wire laid parallel with top coat applied overall; LZL - signifies base coated magnet wire twisted together and covered with top coat overall.

Marking: Company name or trademarks or 榮星電線, material designation or marked designation on packaed or reel, and Recognized Component Mark.

See General Information Preceding These Recognitions
For use only in equipment where the acceptability of the combination is determined by Underwriters Laboratories Inc.

287806002 Page 2 of 2

OBMW2E174837
September 8, 2000

AR-001A



SPECIFICATION FOR APPROVAL

REF :

PAGE: 8

PROD. NAME	WOUND CHIP INDUCTOR	ABC'S DWG NO.	CC2520□□□□3□-□□□
		ABC'S ITEM NO.	

OMFZ2 March 4, 1994
 Component-Plastics
 CHANG CHUN PLASTICS CO LTD E59481 (S)
(F1-cont. from F card)

BM-21	ALL	0.79	94HB	50	50	50	—	—	—	—	—
BM-22	ALL	0.79	94HB	50	50	50	—	—	—	—	—
BM-23	ALL	0.79	94V-0	50	50	50	—	—	—	—	—
EME-1100	BK	0.84	94V-0	130	130	130	—	—	—	—	—
	BK	6.4	94V-0	130	130	130	—	—	—	—	—
EME-1200	BK	0.84	94V-0	130	130	130	—	—	—	—	—
	BK	6.4	94V-0	130	130	130	—	—	—	—	—
EME-5961C	BK	0.3	94V-0	130	130	130	—	—	—	—	—
	BK	3.1	94V-0	130	130	130	—	—	—	—	—

Reports: January 19, 1988: January 19, 1988: January 19, 1988: June 2, 1988;
 June 2, 1998; June 2, 1988.

Replaces E59481C dated February 7, 1989. (Cont. on C1 card)
 262854001 N7047 Underwriters Laboratories Inc.® D11/0018965

AR-001A

