

# Cascadable Silicon Bipolar MMIC Amplifier

## Technical Data

**MSA-0104**

### Features

- **Cascadable 50  $\Omega$  Gain Block**
- **3 dB Bandwidth:**  
DC to 0.8 GHz
- **High Gain:**  
17.0 dB Typical at 0.5 GHz
- **Unconditionally Stable**  
( $k > 1$ )
- **Low Cost Plastic Package**

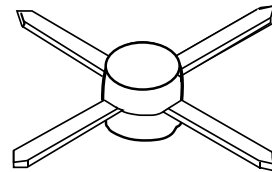
### Description

The MSA-0104 is a high performance silicon bipolar Monolithic Microwave Integrated Circuit (MMIC) housed in a low cost plastic package. This MMIC is

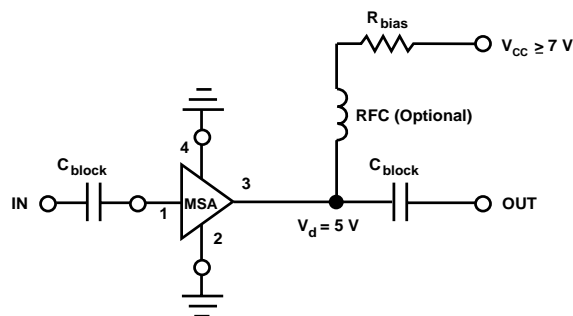
designed for use as a general purpose 50  $\Omega$  gain block. Typical applications include narrow and wide bandwidth IF and RF amplifiers in commercial and industrial applications.

The MSA-series is fabricated using HP's 10 GHz  $f_T$ , 25 GHz  $f_{MAX}$  silicon bipolar MMIC process which uses nitride self-alignment, ion implantation, and gold metallization to achieve excellent performance, uniformity and reliability. The use of an external bias resistor for temperature and current stability also allows bias flexibility.

### 04A Plastic Package



### Typical Biasing Configuration



### MSA-0104 Absolute Maximum Ratings

Parameter	Absolute Maximum <sup>[1]</sup>
Device Current	40 mA
Power Dissipation <sup>[2,3]</sup>	200 mW
RF Input Power	+13 dBm
Junction Temperature	150°C
Storage Temperature	-65 to 150°C

#### Thermal Resistance<sup>[2,4]</sup>:

$$\theta_{jc} = 100^{\circ}\text{C/W}$$

#### Notes:

1. Permanent damage may occur if any of these limits are exceeded.
2.  $T_{\text{CASE}} = 25^{\circ}\text{C}$ .
3. Derate at 10 mW/°C for  $T_{\text{C}} > 130^{\circ}\text{C}$ .
4. See MEASUREMENTS section "Thermal Resistance" for more information.

### MSA-0104 Electrical Specifications<sup>[1]</sup>, $T_{\text{A}} = 25^{\circ}\text{C}$

Symbol	Parameters and Test Conditions: $I_{\text{d}} = 17 \text{ mA}$ , $Z_0 = 50 \Omega$	Units	Min.	Typ.	Max.
$G_{\text{P}}$	Power Gain ( $ S_{21} ^2$ ) $f = 0.1 \text{ GHz}$ $f = 0.5 \text{ GHz}$	dB	17.0	18.5 17.0	
$\Delta G_{\text{P}}$	Gain Flatness $f = 0.1 \text{ to } 0.6 \text{ GHz}$	dB		$\pm 1.0$	
$f_3 \text{ dB}$	3 dB Bandwidth	GHz		0.8	
VSWR	Input VSWR $f = 0.1 \text{ to } 3.0 \text{ GHz}$			1.4:1	
	Output VSWR $f = 0.1 \text{ to } 3.0 \text{ GHz}$			1.3:1	
NF	50 $\Omega$ Noise Figure $f = 0.5 \text{ GHz}$	dB		5.5	
$P_{1 \text{ dB}}$	Output Power at 1 dB Gain Compression $f = 0.5 \text{ GHz}$	dBm		1.5	
$\text{IP}_3$	Third Order Intercept Point $f = 0.5 \text{ GHz}$	dBm		14.0	
tD	Group Delay $f = 0.5 \text{ GHz}$	psec		180	
$V_{\text{d}}$	Device Voltage	V	4.5	5.0	5.5
dV/dT	Device Voltage Temperature Coefficient	mV/°C		-9.0	

#### Notes:

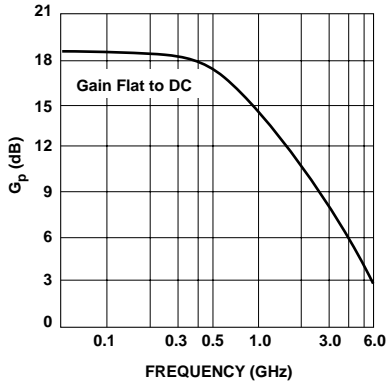
1. The recommended operating current range for this device is 13 to 25 mA. Typical performance as a function of current is on the following page.

### MSA-0104 Typical Scattering Parameters ( $Z_0 = 50 \Omega$ , $T_{\text{A}} = 25^{\circ}\text{C}$ , $I_{\text{d}} = 17 \text{ mA}$ )

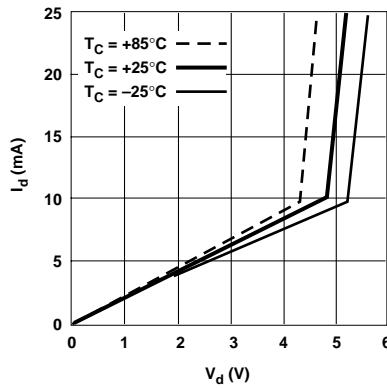
Freq. GHz	$S_{11}$		$S_{21}$			$S_{12}$			$S_{22}$	
	Mag	Ang	dB	Mag	Ang	dB	Mag	Ang	Mag	Ang
0.1	.06	141	18.4	8.31	170	-22.3	.077	5	.07	-9
0.2	.08	112	18.1	8.07	160	-22.3	.077	9	.07	-15
0.3	.10	94	17.8	7.75	151	-22.0	.079	15	.07	-22
0.4	.12	77	17.4	7.38	142	-21.6	.083	16	.07	-32
0.5	.13	70	16.9	7.01	134	-21.0	.089	19	.07	-37
0.6	.14	56	16.4	6.60	127	-20.7	.092	21	.08	-44
0.8	.16	41	15.4	5.87	114	-19.5	.106	27	.08	-53
1.0	.17	28	14.3	5.21	102	-18.9	.114	29	.08	-61
1.5	.17	5	12.1	4.02	78	-16.6	.148	30	.08	-73
2.0	.13	-12	10.2	3.25	59	-14.9	.179	25	.07	-90
2.5	.08	-20	8.9	2.77	46	-13.6	.209	25	.05	-112
3.0	.02	-37	7.7	2.42	31	-12.7	.232	18	.05	-134
3.5	.05	128	6.7	2.15	15	-11.9	.253	10	.06	-160
4.0	.12	113	5.7	1.92	-1	-11.3	.272	2	.06	-175
4.5	.19	97	4.8	1.73	-15	-10.8	.289	-7	.07	173
5.0	.27	80	3.9	1.56	-30	-10.6	.294	-15	.07	150

A model for this device is available in the DEVICE MODELS section.

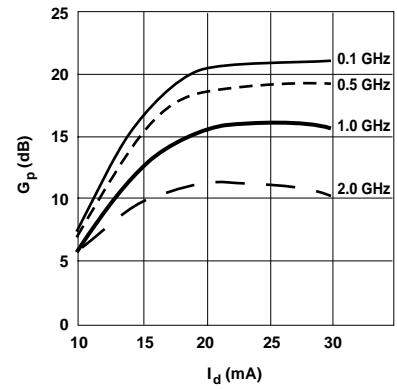
**MSA-0104 Typical Performance,  $T_A = 25^\circ\text{C}$**   
(unless otherwise noted)



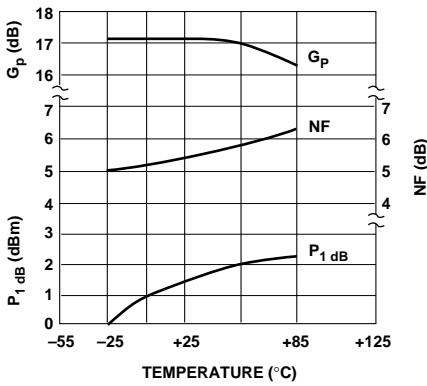
**Figure 1. Typical Power Gain vs. Frequency,  $T_A = 25^\circ\text{C}$ ,  $I_d = 17\text{ mA}$ .**



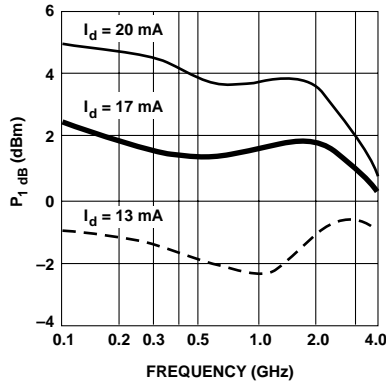
**Figure 2. Device Current vs. Voltage.**



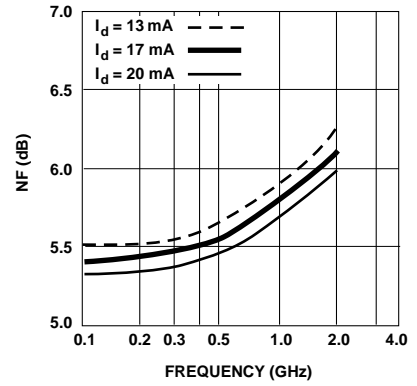
**Figure 3. Power Gain vs. Current.**



**Figure 4. Output Power at 1 dB Gain Compression, NF and Power Gain vs. Case Temperature,  $f = 0.5\text{ GHz}$ ,  $I_d = 17\text{ mA}$ .**

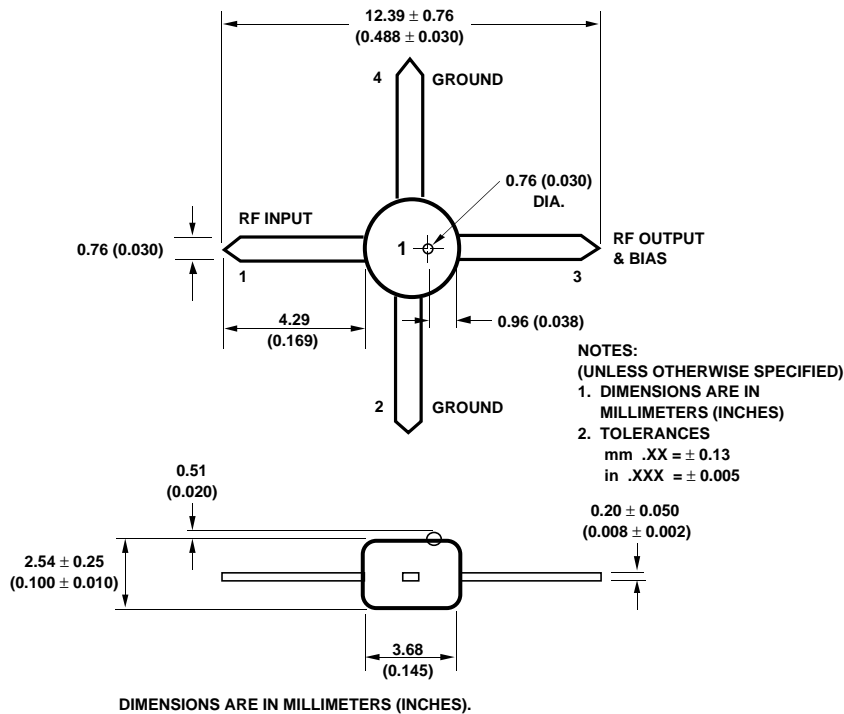


**Figure 5. Output Power at 1 dB Gain Compression vs. Frequency.**



**Figure 6. Noise Figure vs. Frequency.**

## 04A Plastic Package Dimensions



For technical assistance or the location of your nearest Hewlett-Packard sales office, distributor or representative call:

**Americas/Canada:** 1-800-235-0312 or 408-654-8675

**Far East/Australasia:** Call your local HP sales office.

**Japan:** (81 3) 3335-8152

**Europe:** Call your local HP sales office.

Data subject to change.  
 Copyright © 1997 Hewlett-Packard Co.

Printed in U.S.A. 5965-9690E (9/97)