

PLEASE CHECK WWW.MOLEX.COM FOR LATEST PART INFORMATION

Part Number: [0432236022](#)
Status: **Active**
Overview: [modular_plugs_jacks](#)
Description: Modular Jack, Right Angle, Low Profile, 6/4, 2 Ports

Documents:

[3D Model](#) [Product Specification PS-43223-001 \(PDF\)](#)
[Drawing \(PDF\)](#) [RoHS Certificate of Compliance \(PDF\)](#)

Agency Certification

CSA LR19980
 UL E107635

General

Product Family Modular Jacks/Plugs
 Series [43223](#)
 Comments Flush Mount|Flangeless|External Shield
 Component Type PCB Jack
 Magnetic No
 Overview [modular_plugs_jacks](#)
 Performance Category 3, 4
 Power over Ethernet (PoE) N/A
 Product Name RJ11

Physical

Boot Color N/A
 Color - Resin Black
 Durability (mating cycles max) 500
 Flammability 94V-0
 Inverted / Top Latch No
 Lightpipes/LEDs None
 Material - Metal Phosphor Bronze
 Material - Plating Mating Gold
 Material - Plating Termination Tin
 Material - Resin High Temperature Thermoplastic
 Orientation Right Angle (Side Entry)
 PCB Locator Yes
 PCB Retention Yes
 PCB Thickness Recommended (in) 0.062 In
 PCB Thickness Recommended (mm) 1.57 mm
 Packaging Type Tray
 Pitch - Mating Interface (in) 0.040 In
 Pitch - Mating Interface (mm) 1.02 mm
 Pitch - Term. Interface (in) 0.050 In
 Pitch - Term. Interface (mm) 1.27 mm
 Plating min: Mating (µin) 50
 Plating min: Mating (µm) 1.25
 Plating min: Termination (µin) 100
 Plating min: Termination (µm) 2.5
 Ports 2
 Positions / Loaded Contacts 6/4
 Surface Mount Compatible (SMC) No
 Temperature Range - Operating -40°C to +85°C
 Termination Interface: Style Through Hole
 Waterproof / Dustproof No
 Wire/Cable Type N/A

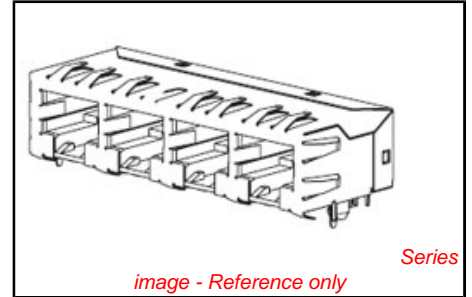

EU RoHS
ELV and RoHS
Compliant
REACH SVHC
 Not Reviewed
Halogen-Free
Status
Not Reviewed

China RoHS



Need more information on product environmental compliance?

Email productcompliance@molex.com
 For a multiple part number RoHS Certificate of Compliance, [click here](#)

Please visit the [Contact Us](#) section for any non-product compliance questions.

Search Parts in this Series
[43223Series](#)

Mates With
 FCC 68 Plugs

Electrical

Current - Maximum per Contact	1.5A
Shielded	No
Voltage - Maximum	150V AC (RMS)

Solder Process Data

Lead-free Process Capability	Wave Capable (TH only)
------------------------------	------------------------

Material Info

Old Part Number	A432236022
-----------------	------------

Reference - Drawing Numbers

Packaging Specification	PK-43249-004
Product Specification	PS-43223-001
Sales Drawing	SDA-43223
Test Summary	TS-43223-001

This document was generated on 06/07/2010

PLEASE CHECK WWW.MOLEX.COM FOR LATEST PART INFORMATION

NOTES:

- 1) MATERIAL:
HOUSING: GLASS FILLED NYLON, UL94V-0, COLOR: BLACK
INSULATOR: GLASS FILLED NYLON, UL94V-0, COLOR: BLACK
TERMINALS: PHOSPHOR BRONZE: .012/ 0.30 THICK
- 2) FINISH:
TERMINALS:
SELECT GOLD IN CONTACT AREA: 50 MICRONS/ 1.27 MICROMETERS MIN.
*SELECT TIN IN PC TAIL AREA: 100 MICRONS/ 2.54 MICROMETERS MIN.
WITH OVERALL NICKEL UNDERPLATE: 50 MICRONS/ 1.27 MICROMETERS MIN.
*THE PRIMARY SHIPPING CARTON WILL BE LABELED 'COMPLIANT TO ROHS DIRECTIVE 2002/95/EC AND ELV ANNEX II OF DIRECTIVE 2000/53/EC'. CARTONS WITHOUT THIS LABEL MAY CONTAIN PRODUCT WITH TIN-LEAD IN THE PC TAIL AREA.
- 3) PRODUCT SPECIFICATION AND PROCESSING PARAMETERS: PS-43223-001.
- 4) PACKAGING SPECIFICATION:
UNSHIELDED CONNECTOR ASSEMBLIES PACKAGED IN TRAYS PER MOLEX PACKAGING SPECIFICATION PK-43249-004.
- 5) SEE SHEETS 4-6 FOR P.C. BOARD LAYOUTS.
- 6) SEE SHEET 2 FOR THE SHIELDED JACK ASSEMBLY.
- 7) FOR 6 CIRCUIT JACKS CENTERLINE TO CENTERLINE SPACING IS .448/ 11.38, FOR 8 CIRCUIT JACKS CENTERLINE TO CENTERLINE SPACING IS .550/ 13.97.
- 8) ALL UNTOLERANCED DIMENSIONS ARE SHOWN FOR REFERENCE ONLY.
- 9) THIS PART CONFORMS TO CLASS B REQUIREMENTS OF COSMETIC SPECIFICATION PS-45499-002.

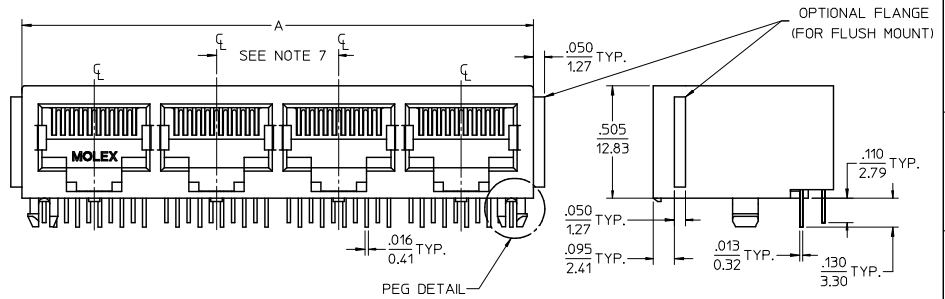

4 PORT 8 LOADED
10 JACK SHOWN

UNSHIELDED GANGED JACK ASSEMBLY
SEE SHEET 3

CENTER PEG
(8 PORT ASSY. ONLY)

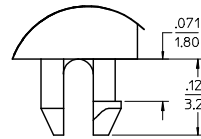

SNAP-FIT
PEG DETAIL
SCALE 8:1

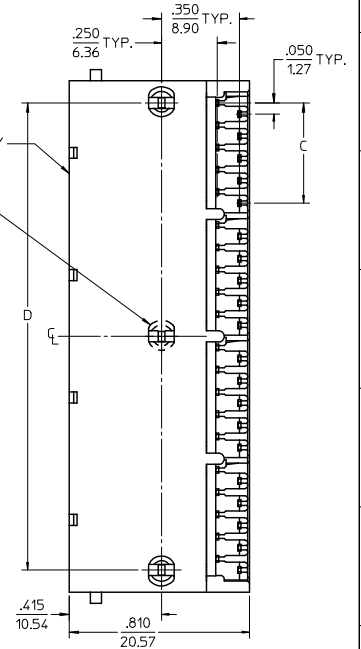

6 CIRCUIT HOUSING

CIRCUIT SIZE	NO. OF PORTS	DIM. A	DIM. C	DIM. D
6	2	.985 (25.02)	.250 (6.35)	.848 (21.54)
4	2	.985 (25.02)	.150 (3.81)	.848 (21.54)
2	2	.985 (25.02)	.050 (1.27)	.848 (21.54)
6	3	1.433 (36.40)	.250 (6.35)	1.296 (32.92)
4	3	1.433 (36.40)	.150 (3.81)	1.296 (32.92)
2	3	1.433 (36.40)	.050 (1.27)	1.296 (32.92)
6	4	1.881 (47.78)	.250 (6.35)	1.744 (44.30)
4	4	1.881 (47.78)	.150 (3.81)	1.744 (44.30)
2	4	1.881 (47.78)	.050 (1.27)	1.744 (44.30)
6	5	2.329 (59.16)	.250 (6.35)	2.192 (55.68)
4	5	2.329 (59.16)	.150 (3.81)	2.192 (55.68)
2	5	2.329 (59.16)	.050 (1.27)	2.192 (55.68)
6	6	2.777 (70.54)	.250 (6.35)	2.640 (67.06)
4	6	2.777 (70.54)	.150 (3.81)	2.640 (67.06)
2	6	2.777 (70.54)	.050 (1.27)	2.640 (67.06)
6	8	3.673 (93.29)	.250 (6.35)	3.536 (89.81)
4	8	3.673 (93.29)	.150 (3.81)	3.536 (89.81)
2	8	3.673 (93.29)	.050 (1.27)	3.536 (89.81)

8 CIRCUIT HOUSING

CIRCUIT SIZE	NO. OF PORTS	DIM. A	DIM. C	DIM. D
10	2	1.200 (30.48)	.450 (11.43)	1.000 (25.40)
8	2	1.200 (30.48)	.350 (8.89)	1.000 (25.40)
6	2	1.200 (30.48)	.250 (6.35)	1.000 (25.40)
10	3	1.750 (44.45)	.450 (11.43)	1.550 (39.37)
8	3	1.750 (44.45)	.350 (8.89)	1.550 (39.37)
6	3	1.750 (44.45)	.250 (6.35)	1.550 (39.37)
4	3	1.750 (44.45)	.150 (3.81)	1.550 (39.37)
10	4	2.300 (58.42)	.450 (11.43)	2.100 (53.34)
8	4	2.300 (58.42)	.350 (8.89)	2.100 (53.34)
4	4	2.300 (58.42)	.150 (3.81)	2.100 (53.34)
4	5	2.850 (72.39)	.450 (11.43)	2.650 (67.31)
10	5	2.850 (72.39)	.350 (8.89)	2.650 (67.31)
8	5	2.850 (72.39)	.250 (6.35)	2.650 (67.31)
10	6	3.400 (86.36)	.450 (11.43)	3.200 (81.28)
8	6	3.400 (86.36)	.350 (8.89)	3.200 (81.28)
10	8	4.500 (114.30)	.450 (11.43)	4.300 (109.22)
8	8	4.500 (114.30)	.350 (8.89)	4.300 (109.22)

ADD BLOCK TOL EC NO. IUP2009-0477 2008/09/05 DRWN:JBELL 2008/09/11 CHKD:JBELL 2008/09/11 APPR:SPWTH 2008/09/11	QUALITY SYMBOLS ▽=0 ▽=0	GENERAL TOLERANCES (UNLESS SPECIFIED) 4 PLACES ± --- ± --- 3 PLACES ± --- ± .015 2 PLACES ± 0.38 ± --- 1 PLACE ± --- ± --- ANGULAR ±1/2°		DIMENSION STYLE IN/MM	SCALE 3:1	DESIGN UNITS INCH	THIRD ANGLE PROJECTION
		DRAWN BY JTR	DATE 1993/10/18	TITLE LOW PROFILE GANGED, RIGHT ANGLE MODULAR JACK ASSEMBLY			
		CHECKED BY JTR	DATE 1993/10/18	MOLEX INCORPORATED			
		APPROVED BY RAS	DATE 1993/10/18	MATERIAL NO. SEE SHTS 3	DOCUMENT NO. SDA-43223	SHEET NO. 1 OF 6	
DRAFT WHERE APPLICABLE MUST REMAIN WITHIN DIMENSIONS		THIS DRAWING CONTAINS INFORMATION THAT IS PROPRIETARY TO MOLEX INCORPORATED AND SHOULD NOT BE USED WITHOUT WRITTEN PERMISSION					

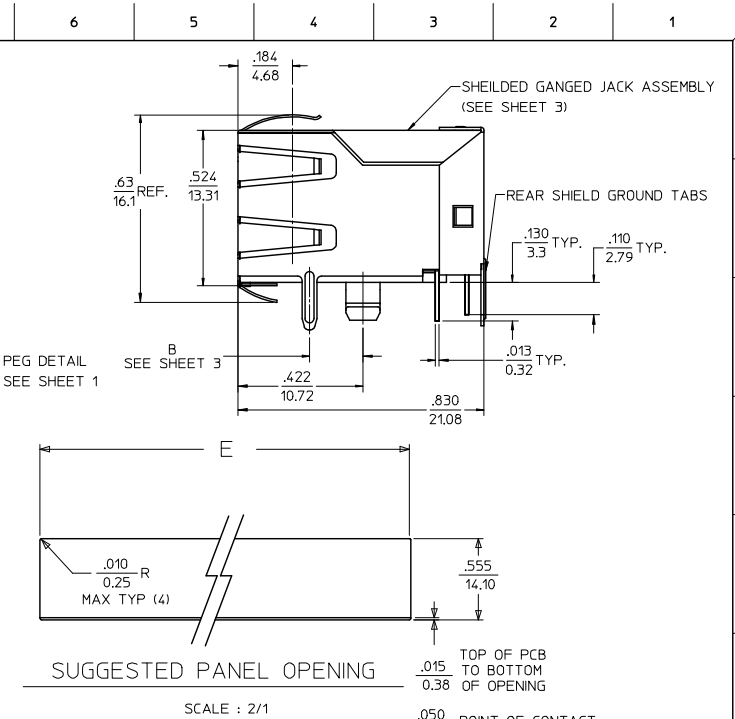
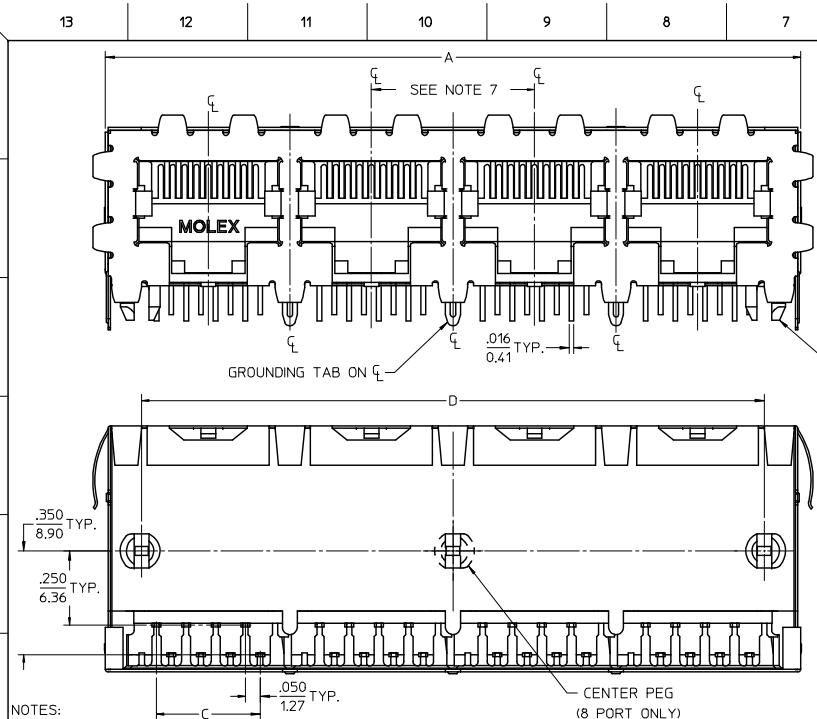

- NOTES:
- MATERIAL:
 - HOUSING: GLASS FILLED NYLON, UL94V-0, COLOR: BLACK
 - INSULATOR: GLASS FILLED NYLON, UL94V-0, COLOR: BLACK
 - TERMINALS: PHOSPHOR BRONZE: .012/ 0.30 THICK
 - SHIELD: BRASS, FRONT .007/ 0.18 THICK, REAR .010/ 0.25 THICK
 - FINISH:
 - TERMINALS:
 - SELECT GOLD IN CONTACT AREA: 50 MICRONS/ 1.27 MICROMETERS MIN.,
 - SELECT TIN IN PC TAIL AREA: 100 MICRONS/ 2.54 MICROMETERS MIN.,
 - WITH OVERALL NICKEL UNDERPLATE: 50 MICRONS/ 1.27 MICROMETERS MIN.
 - SHIELD:
 - 100 MICRONS/ 2.54 MICROMETERS NICKEL OVER 50 MICRONS/ 1.27 MICROMETERS COPPER UNDERPLATE. PCB GROUND TABS DIPPED IN TIN
 - THE PRIMARY SHIPPING CARTON WILL BE LABELED "COMPLIANT TO RoHS DIRECTIVE 2002/95/EC AND ELV ANNEX II OF DIRECTIVE 2000/53/EC". CARTONS WITHOUT THIS LABEL MAY CONTAIN PRODUCT WITH TIN-LEAD IN THE PC TAIL AND/OR SHIELD.
 - PRODUCT SPECIFICATION AND PROCESSING PARAMETERS: PS-43223-001.
 - PACKAGING SPECIFICATION:
 - SHIELDED CONNECTOR ASSEMBLIES PACKAGED IN TRAYS PER MOLEX PACKAGING SPECIFICATION PK-44150-004.
 - SEE SHEETS 4-6 FOR P.C. BOARD LAYOUTS.
 - REAR SHIELD IS AVAILABLE WITH (1) CENTERED GROUND TAB ON 4 & 8 PORT VERSIONS.
 - 8 CIRCUIT JACKS CENTERLINE TO CENTERLINE SPACING IS .550/ 13.97.
 - ALL UNTOLERANCED DIMENSIONS ARE SHOWN FOR REFERENCE ONLY.
 - THIS PART CONFORMS TO CLASS B REQUIREMENTS OF COSMETIC SPECIFICATION PS-45499-002.

HOUSING SIZE	CIRCUIT SIZE	NO. OF PORTS	DIM. A	DIM. C	DIM. D	DIM. E
8	8	2	1.224 (31.09)	.350 (8.89)	1.000 (25.40)	1.255 (31.88)
8	8	4	2.324 (59.03)	.350 (8.89)	2.100 (53.34)	2.355 (59.82)
8	8	6	3.424 (86.97)	.350 (8.89)	3.200 (81.28)	3.455 (87.76)
8	8	8	4.524 (114.91)	.350 (8.89)	4.300 (109.22)	4.555 (115.97)
8	2	8	4.524 (114.91)	.050 (1.27)	4.300 (109.22)	4.555 (115.97)

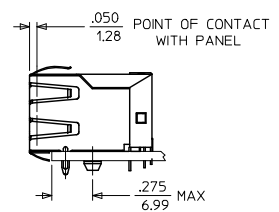

4 PORT 8 LOADED
8 JACK SHOWN

SEE SHEET 1 EC NO. UCP2009-0477 DRWN:JBELL 2008/09/11 CHKD:JBELL 2008/09/11 APPR:SMITH 2008/09/11 K1	QUALITY SYMBOLS	GENERAL TOLERANCES (UNLESS SPECIFIED)	DIMENSION STYLE IN/MM	SCALE 4:1	DESIGN UNITS INCH	THIRD ANGLE PROJECTION
	$\nabla=0$ $\nabla=0$	4 PLACES ± .015 3 PLACES ± .015 2 PLACES ± 0.38 1 PLACE ± .015 ANGULAR ± 1/2°	DRAWN BY JTR DATE 1993/10/18 CHECKED BY JTR DATE 1993/10/18 APPROVED BY RAS DATE 1993/10/18	TITLE	LOW PROFILE GANGED, RIGHT ANGLE MODULAR JACK ASSEMBLY	
	DRAFT WHERE APPLICABLE MUST REMAIN WITHIN DIMENSIONS	SEE SHTS 3	MATERIAL NO.	MOLEX INCORPORATED SDA-43223		
			SIZE	THIS DRAWING CONTAINS INFORMATION THAT IS PROPRIETARY TO MOLEX INCORPORATED AND SHOULD NOT BE USED WITHOUT WRITTEN PERMISSION		

13 12 11 10 9 8 7 6 5 4 3 2 1

FLUSH MOUNT (UNSHIELDED)

ASSEMBLY NUMBER	CONNECTOR SIZE	NUMBER OF CIRCUITS	NUMBER OF PORTS	PACKAGING STYLE	PACKAGING SPECIFICATION
43223-6001	6	6	2	TRAY	PK-43249-004
43223-6004	6	6	3	↑	↑
43223-6007	6	6	4	↑	↑
43223-6010	6	6	5	↑	↑
43223-6013	6	6	6	↑	↑
43223-6019	6	6	8	↑	↑
43223-6022	6	4	2	↑	↑
43223-6025	6	4	3	↑	↑
43223-6028	6	4	4	↑	↑
43223-6031	6	4	5	↑	↑
43223-6034	6	4	6	↑	↑
43223-6040	6	4	8	↑	↑
43223-6043	6	2	2	↑	↑
43223-6046	6	2	3	↑	↑
43223-6049	6	2	4	↑	↑
43223-6052	6	2	5	↑	↑
43223-6055	6	2	6	↑	↑
43223-6058	6	2	8	TRAY	PK-43249-004

FLANGELESS (UNSHIELDED)

ASSEMBLY NUMBER	CONNECTOR SIZE	NUMBER OF CIRCUITS	NUMBER OF PORTS	PACKAGING STYLE	PACKAGING SPECIFICATION
43223-6101	6	6	2	TRAY	PK-43249-004
43223-6104	6	6	3	↑	↑
43223-6107	6	6	4	↑	↑
43223-6110	6	6	5	↑	↑
43223-6113	6	6	6	↑	↑
43223-6119	6	6	8	↑	↑
43223-6122	6	4	2	↑	↑
43223-6125	6	4	3	↑	↑
43223-6128	6	4	4	↑	↑
43223-6131	6	4	5	↑	↑
43223-6134	6	4	6	↑	↑
43223-6140	6	4	8	↑	↑
43223-6143	6	2	2	↑	↑
43223-6146	6	2	3	↑	↑
43223-6149	6	2	4	↑	↑
43223-6152	6	2	5	↑	↑
43223-6155	6	2	6	↑	↑
43223-6158	6	2	8	TRAY	PK-43249-004

43223-8001	8	10	2	TRAY	PK-43249-004
43223-8004	8	10	3	↑	↑
43223-8007	8	10	4	↑	↑
43223-8010	8	10	5	↑	↑
43223-8013	8	10	6	↑	↑
43223-8019	8	10	8	↑	↑
43223-8022	8	8	2	↑	↑
43223-8025	8	8	3	↑	↑
43223-8028	8	8	4	↑	↑
43223-8031	8	8	5	↑	↑
43223-8034	8	8	6	↑	↑
43223-8040	8	8	8	↑	↑
43223-8041	8	4	5	↓	↓
43223-8042	8	6	3	TRAY	PK-43249-004

43223-8101	8	10	2	TRAY	PK-43249-004
43223-8104	8	10	3	↑	↑
43223-8107	8	10	4	↑	↑
43223-8110	8	10	5	↑	↑
43223-8113	8	10	6	↑	↑
43223-8119	8	10	8	↑	↑
43223-8122	8	8	2	↑	↑
43223-8131	8	8	3	↑	↑
43223-8140	8	8	4	↑	↑
43223-8149	8	8	5	↑	↑
43223-8158	8	8	6	↓	↓
43223-8176	8	8	8	TRAY	PK-43249-004

43223-8191	8	6	2	TUBE	PK-43249-005
43223-8192	8	4	4	TUBE	PK-43249-005
43223-8193	8	4	3	TUBE	PK-43249-005
43223-8195	8	8	2	TUBE	PK-43249-005
43223-8196	8	8	3	TUBE	PK-43249-005
43223-8197	8	8	4	TUBE	PK-43249-005

FLANGELESS (SHIELDED)

ASSEMBLY NUMBER	DIMENSION "B"	CONNECTOR SIZE	NUMBER OF CIRCUITS	NUMBER OF PORTS	NUMBER OF REAR SHIELD GROUND TABS	PACKAGING STYLE	PACKAGING SPECIFICATION
43223-8128	.180	8	8	2	1	TRAY	PK-44150-004
43223-8146	.180	8	8	4	3	↑	↑
43223-8164	.180	8	8	6	5	↑	↑
43223-8182	.180	8	8	8	7	↑	↑
43223-8185	.180	8	8	8	1	↑	↑
43223-8188	.180	8	8	4	1	↓	↓
43223-8194	.180	8	2	8	7	TRAY	PK-44150-004

43223-8301	.145	8	8	2	1	TRAY	PK-44150-004
43223-8302	.145	8	8	4	3	↑	↑
43223-8303	.145	8	8	6	5	↑	↑
43223-8304	.145	8	8	8	7	↑	↑
43223-8305	.145	8	8	8	1	↑	↑
43223-8306	.145	8	8	4	1	↓	↓
43223-8307	.145	8	2	8	7	TRAY	PK-44150-004

SNAP FIT PEG VERSIONS

SEE SHEET 1 EC NO: UCP2009-0477 DRWN: J.BELL 2008/09/11 CHKD: J.BELL 2008/09/11 APPR: S.SMITH 2008/09/11 K1	QUALITY SYMBOLS ▽=0 ▽=0	GENERAL TOLERANCES (UNLESS SPECIFIED)	DIMENSION STYLE IN/MM	SCALE 2:1	DESIGN UNITS INCH	THIRD ANGLE PROJECTION
		4 PLACES ±.005 ±.005	DRAWN BY JTR DATE 1993/10/18	TITLE LOW PROFILE GANGED, RIGHT ANGLE MODULAR JACK ASSEMBLY		
		3 PLACES ±.010 ±.015	CHECKED BY JTR DATE 1993/10/18	MOLEX INCORPORATED		
		2 PLACES ±0.38 ±.005	APPROVED BY RAS DATE 1993/10/18	MATERIAL NO. SDA-43223	DOCUMENT NO.	SHEET NO. 3 OF 6
DRAFT WHERE APPLICABLE MUST REMAIN WITHIN DIMENSIONS		THIS DRAWING CONTAINS INFORMATION THAT IS PROPRIETARY TO MOLEX INCORPORATED AND SHOULD NOT BE USED WITHOUT WRITTEN PERMISSION				

12 11 10 9 8 7 6 5 4 3 2 1

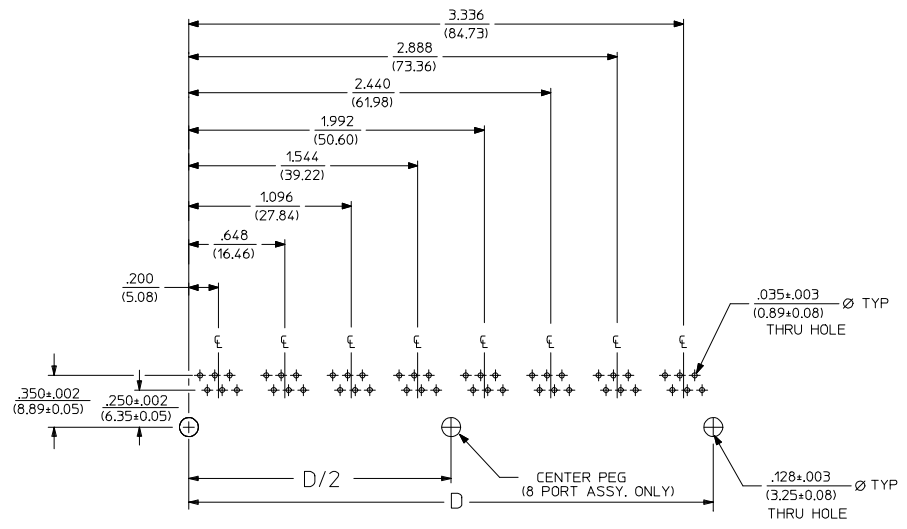
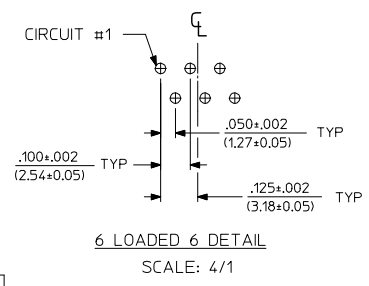
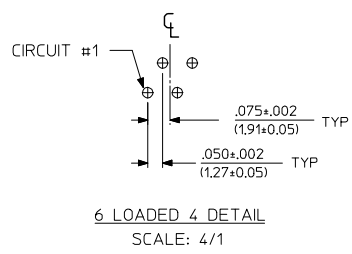
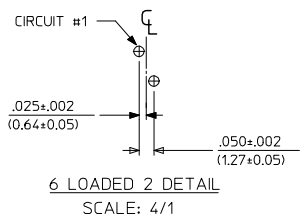

**SUGGESTED P.C. BOARD LAYOUT
COMPONENT SIDE OF BOARD
8 PORT, 6 LOADED 6, LAYOUT SHOWN
(SNAP-FIT VERSIONS)**

NOTES:
1. RECOMMENDED PCB THICKNESS .062±.005/(1.57±0.13)

NUMBER OF PORTS	DIM. D
2	.848 (21.54)
3	1.296 (32.92)
4	1.744 (44.30)
5	2.192 (55.68)
6	2.640 (67.06)
8	3.536 (89.81)

SEE SHEET 1 EC NO. UCP2009-0477 DRWN:JBELL 2008/09/05 CHKD:JBELL 2008/09/11 APPR:PSMITH 2008/09/11 K1	QUALITY SYMBOLS ▽=0 ▽=0	GENERAL TOLERANCES (UNLESS SPECIFIED) mm INCH		DIMENSION STYLE IN/MM		SCALE 2:1	DESIGN UNITS INCH	THIRD ANGLE PROJECTION		
		4 PLACES ±--- ±---	3 PLACES ±--- ±.015	2 PLACES ±0.38 ±---	1 PLACE ±--- ±---	ANGULAR ±1/2°	DRAWN BY JTR DATE 1993/10/18	TITLE LOW PROFILE GANGED, RIGHT ANGLE MODULAR JACK ASSEMBLY		
		DRAFT WHERE APPLICABLE MUST REMAIN WITHIN DIMENSIONS		SEE SHT 3	MATERIAL NO. RAS		APPROVED BY RAS DATE 1993/10/18	MOLEX INCORPORATED		
				SIZE C	THIS DRAWING CONTAINS INFORMATION THAT IS PROPRIETARY TO MOLEX INCORPORATED AND SHOULD NOT BE USED WITHOUT WRITTEN PERMISSION		DOCUMENT NO. SDA-43223		SHEET NO. 4 OF 6	

13 12 11 10 9 8 7 6 5 4 3 2 1

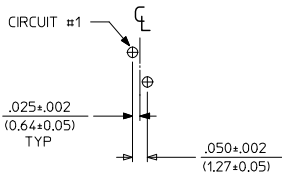

8 LOADED 2 DETAIL
SCALE: 4/1

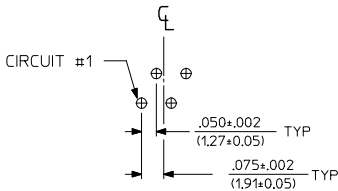

8 LOADED 4 DETAIL
SCALE: 4/1

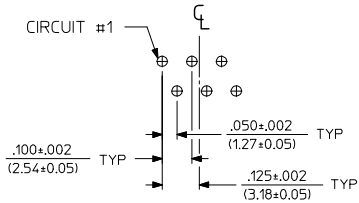

8 LOADED 6 DETAIL
SCALE: 4/1

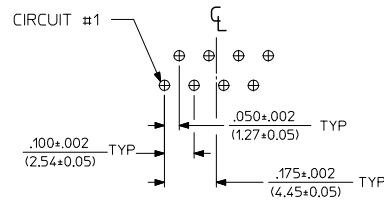

8 LOADED 8 DETAIL
SCALE: 4/1

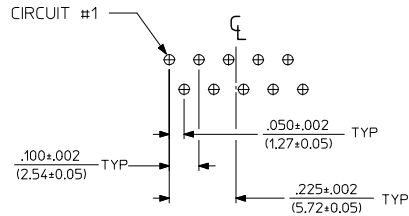

8 LOADED 10 DETAIL
SCALE: 4/1

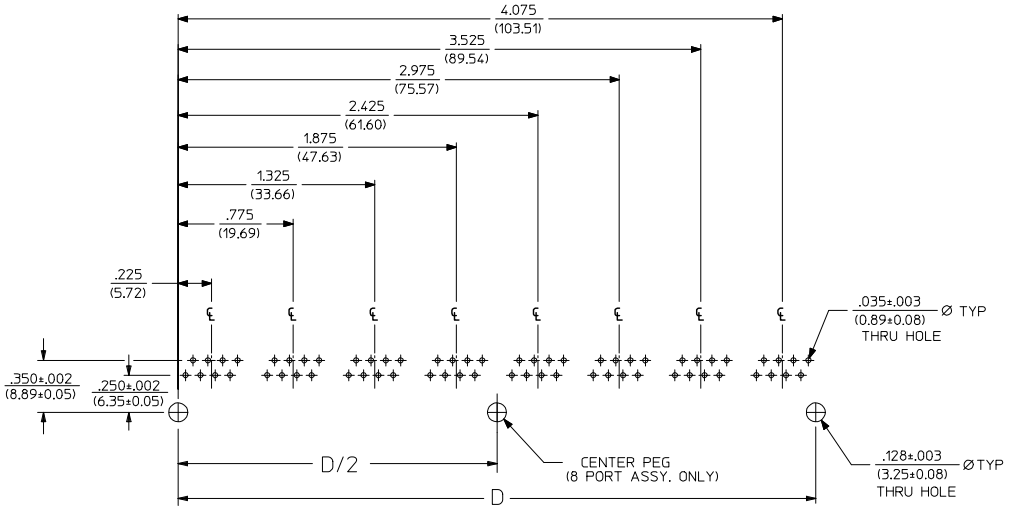

SUGGESTED P.C. BOARD LAYOUT
COMPONENT SIDE OF BOARD
8 PORT, 8 LOADED 8
(SNAP-FIT VERSIONS)

NOTES:
1. RECOMMENDED PCB THICKNESS: .062±.005/(1.57±0.13)

NUMBER OF PORTS	DIM. D
2	1.000 (25.40)
3	1.550 (39.37)
4	2.100 (53.34)
5	2.650 (67.31)
6	3.200 (81.28)
8	4.300 (109.32)

SEE SHEET 1 EC NO: UCP2009-0477 DRAWN: J.BELL 2008/09/11 CHKD: J.BELL 2008/09/11 APPR: J.SMITH 2008/09/11 REV: K1	QUALITY SYMBOLS	GENERAL TOLERANCES (UNLESS SPECIFIED)	DIMENSION STYLE IN/MM	SCALE 2:1	DESIGN UNITS INCH	THIRD ANGLE PROJECTION	
	▽=0 ▽=0	4 PLACES ±.015 3 PLACES ±.015 2 PLACES ±0.38 1 PLACE ±.015 ANGULAR ±1/2°	mm INCH DRAWN BY JTR DATE 1993/10/18 CHECKED BY JTR DATE 1993/10/18 APPROVED BY RAS DATE 1993/10/18			TITLE	
		DRAFT WHERE APPLICABLE MUST REMAIN WITHIN DIMENSIONS	SEE SHT 3				LOW PROFILE GANGED, RIGHT ANGLE MODULAR JACK ASSEMBLY
							MOLEX INCORPORATED
						MATERIAL NO. SDA-43223	
						DOCUMENT NO. 5 OF 6	
						SHEET NO. 5 OF 6	
						THIS DRAWING CONTAINS INFORMATION THAT IS PROPRIETARY TO MOLEX INCORPORATED AND SHOULD NOT BE USED WITHOUT WRITTEN PERMISSION	

12 11 10 9 8 7 6 5 4 3 2 1

13 12 11 10 9 8 7 6 5 4 3 2 1

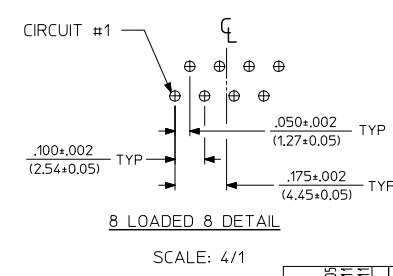
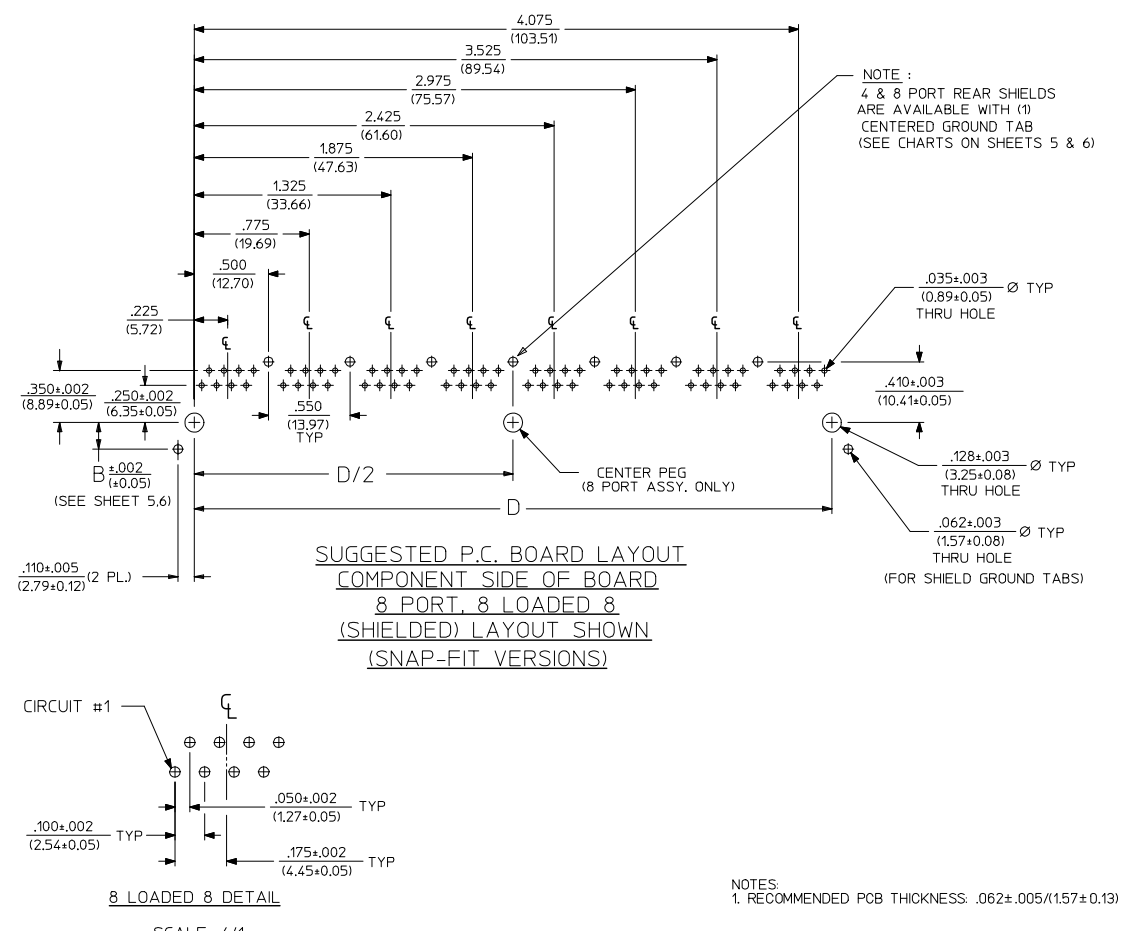
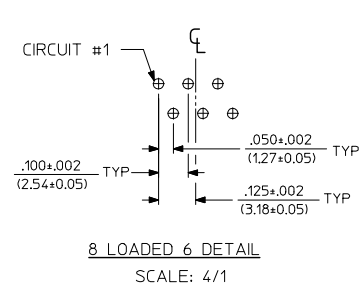
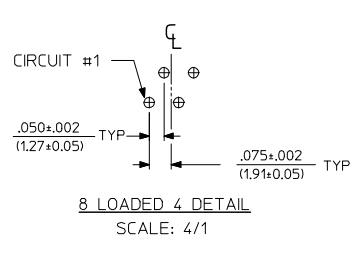
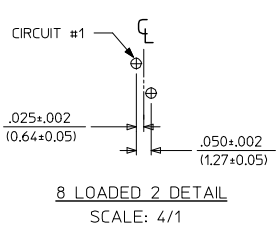

NUMBER OF PORTS	DIM. D
2	1.000 (25.40)
4	2.100 (53.34)
6	3.200 (81.28)
8	4.300 (109.32)

SEE SHEET 1 EC NO: UCP2009-0477 DRWN: JBEL 2008/09/05 CHKD: JBEL 2008/09/11 APPR: SMITH 2008/09/11 K1	QUALITY SYMBOLS ▽=0 ▽=0	GENERAL TOLERANCES (UNLESS SPECIFIED) 4 PLACES ±.005 ±.005 3 PLACES ±.005 ±.015 2 PLACES ±.038 ±.038 1 PLACE ±.038 ±.038 ANGULAR ±1/2°	DIMENSION STYLE IN/MM DRAWN BY: JTR DATE: 1993/10/18 CHECKED BY: JTR DATE: 1993/10/18 APPROVED BY: RAS DATE: 1993/10/18	SCALE: 2:1 DESIGN UNITS: INCH THIRD ANGLE PROJECTION	TITLE: LOW PROFILE GANGED, RIGHT ANGLE MODULAR JACK ASSEMBLY MOLEX INCORPORATED
	DRAFT WHERE APPLICABLE MUST REMAIN WITHIN DIMENSIONS	MATERIAL NO.: SEE SHT 3 SIZE: C	DOCUMENT NO.: SDA-43223	SHEET NO.: 6 OF 6	
	THIS DRAWING CONTAINS INFORMATION THAT IS PROPRIETARY TO MOLEX INCORPORATED AND SHOULD NOT BE USED WITHOUT WRITTEN PERMISSION				
	THIS DRAWING CONTAINS INFORMATION THAT IS PROPRIETARY TO MOLEX INCORPORATED AND SHOULD NOT BE USED WITHOUT WRITTEN PERMISSION				

12 11 10 9 8 7 6 5 4 3 2 1