

APPLICATION

- Neutrino Physics

FEATURES

- Large Photocathode Area
- Fast Time Response
- High Stability
- Less Dark Count

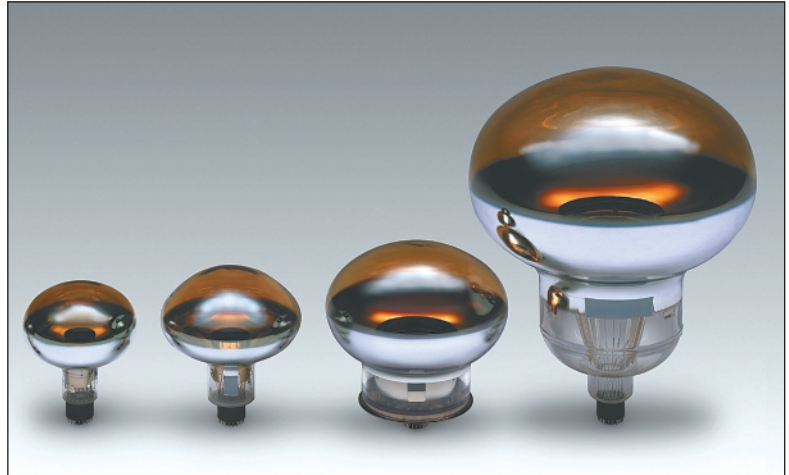

R5912
R5912-02

R7081
R7081-20

R8055

R3600-02
R7250

SPECIFICATIONS

Type No.	Diameter (mm) / (inch)	Minimum Effective Area (mm)	Surface Area		Dynode		Weight (g)
			Min. (cm ²)	Typ. (cm ²)	Structure	Number of Stages	
R5912	202 / 8	φ190	330	380	Box & Line	10	approx. 1100
R5912-02	202 / 8	φ190	330	380	Box & Line	14	approx. 1100
R7081	253 / 10	φ220	470	530	Box & Line	10	approx. 1400
R7081-20	253 / 10	φ220	470	530	Box & Line	14	approx. 1400
R8055	332 / 13	φ312	960	1080	Box & Line	10	approx. 3000
R3600-02	508 / 20	φ460	2030	2410	Venetian blind	11	approx. 8000
R7250	508 / 20	φ430	1680	1740	Box & Line	10	approx. 8000

COMMON SPECIFICATIONS

Spectral Response	300 nm to 650 nm
Peak Wavelength	420 nm
Photocathode Material	Bialkali
Window Material	Borosilicate glass

Subject to local technical requirements and regulations, availability of products included in this promotional material may vary. Please consult with our sales office. Information furnished by HAMAMATSU is believed to be reliable. However, no responsibility is assumed for possible inaccuracies or omissions. Specifications are subject to change without notice. No patent rights are granted to any of the circuits described herein. ©2008 Hamamatsu Photonics K.K.

LARGE PHOTOCATHODE AREA PHOTOMULTIPLIER TUBES

SPECIFICATIONS

Type No.	Cathode Sensitivity					Anode Sensitivity				
	Luminous (2856 K)		Radiant at 420 nm Typ. (mA/W)	Blue Sensitivity Index (CS 5-58)		Quantum Efficiency at 390 nm Typ. (%)	Luminous (2856 K) Typ. (A/lm)	Radiant at 420 nm Typ. (A/W)	Gain Typ.	Applied Voltage for Typical Gain Typ. (V)
	Min. (μ A/lm)	Typ. (μ A/lm)		Min.	Typ.					
R5912	40	80	80	6.0	10.0	25	700	7.2×10^5	1.0×10^7	1500
R5912-02	40	80	80	6.0	10.0	25	70 000	7.2×10^7	1.0×10^9	1700
R7081	40	80	80	6.0	10.0	25	800	8.0×10^5	1.0×10^7	1500
R7081-20	40	80	80	6.0	10.0	25	80 000	8.0×10^7	1.0×10^9	1700
R8055	35	60	65	5.5	8.0	20	3000	3.25×10^6	5.0×10^7	2000
R3600-02	35	60	65	5.5	8.0	20	600	6.5×10^5	1.0×10^7	2000
R7250	35	60	65	5.5	8.0	20	600	6.5×10^5	1.0×10^7	2000

NOTE: Anode characteristics are measured with the voltage distribution ratio shown below.
(): Measured with the special voltage distribution ratio (Tapered Divider) shown below.

Type No.	Maximum Ratings							Direct Interelectrode Capacitances	
	Supply Voltage		Average Anode Current (mA)	Operating Ambient Temperature ($^{\circ}$ C)	Storage Temperature ($^{\circ}$ C)	Ambient Pressure (Gauge) (MPa)	Anode to Last Dynode (pF)	Anode to All Other Dynodes (pF)	
	Anode to Cathode (V)	Anode to Last Dynode (V)							
R5912	2000	300	0.1	-30 to +50	-30 to +50	0.7	approx. 3	approx. 7	
R5912-02	2000	300	0.1	-30 to +50	-30 to +50	0.7	approx. 3	approx. 7	
R7081	2000	300	0.1	-30 to +50	-30 to +50	0.7	approx. 3	approx. 7	
R7081-20	2000	300	0.1	-30 to +50	-30 to +50	0.7	approx. 3	approx. 7	
R8055	2500	300	0.1	-30 to +50	-30 to +50	0.15	approx. 10	approx. 20	
R3600-02	2500	300	0.1	-30 to +50	-30 to +50	0.6	approx. 36	approx. 40	
R7250	2500	300	0.1	-30 to +50	-30 to +50	0.6	approx. 10	approx. 15	

Anode Sensitivity

(at +25 °C)

Dark Current (After 30 min storage in darkness)		Dark Count (After 15 hours storage in darkness)		Time Response			Single Photo-electron (Peak to valley ratio)		Pulse Linearity		Type No.
Typ. (nA)	Max. (nA)	Typ. (s ⁻¹)	Max. (s ⁻¹)	Rise Time Typ. (ns)	Electron Transit Time Typ. (ns)	Transit Time Spread (FWHM) Typ. (ns)	Min.	Typ.	at ±2 % Deviation Typ. (mA)	at ±5 % Deviation Typ. (mA)	
50	700	4000	8000	3.8	55	2.4	1.5	2.5	20 (60)	40 (80)	
1000	5000	6000	12 000	4	68	2.8	1.5	2.5	40	70	R5912-02
50	700	7000	15 000	4.3	63	2.9	1.5	2.5	20 (60)	40 (80)	R7081
1000	5000	9000	19 000	4.5	78	3.3	1.5	2.5	40	70	R7081-20
200	1000	15 000	30 000	5.3	88	2.8	1.5	2.5	60	80	R8055
200	1000	25 000	80 000	10	95	5.5	1.1	1.7	20	40	R3600-02
200	1000	25 000	80 000	7	110	3.5	1.5	2.5	60	80	R7250

Type No.	Supply Voltage (V)	Voltage Distribution Ratio K: Photocathode Dy: Dynode P: Anode F: Focus																		
		K	Dy1	F2	F1	F3	Dy2	Dy3	Dy4	Dy5	Dy6	Dy7	Dy8	Dy9	Dy10	P				
R5912, R7081	1500	11.3	0	0.6	0	3.4	5	3.33	1.67	1	1	1	1	1	1	1				
		Capacitors in μF										0.01	0.01	0.01						
R5912, R7081 (Taperd Divider)	1500	11.3	0	0.6	0	3.4	5	3.33	1.67	1	1.2	1.5	2.2	3	2.4					
		Capacitors in μF										0.01	0.01	0.01						
R8055	2000	18.5	0	0.6	0	3.4	5	3.3	1.7	1	1	1	2	3	4					
		Capacitors in μF										0.01	0.01	0.01						
R7250	2000	18.5	0	0.6	0	3.4	5	3.3	1.7	1	1	1	2	3	4					
		Capacitors in μF										0.01	0.01	0.01						
R3600-02	2000	K	F2	F1	F3	Dy1	Dy2	Dy3	Dy4	Dy5	Dy6	Dy7	Dy8	Dy9	Dy10	Dy11	P			
		5	1	2	0.02	3	1	1	1	1	1	1	1	1	1	1	1			
Capacitors in μF										0.01	0.01	0.01								
R5912-02 R7081-20	1700	K	Dy1	F2	F1	F3	Dy2	Dy3	Dy4	Dy5	Dy6	Dy7	Dy8	Dy9	Dy10	Dy11	Dy12	Dy13	Dy14	P
		11.3	0	0.6	0	3.4	5	3.33	1.67	1	1	1	1	1	1.2	1.5	2.2	3	2.4	
Capacitors in μF										0.01	0.01	0.01	0.02	0.02						

LARGE PHOTOCATHODE AREA PHOTOMULTIPLIER TUBES

SPECTRAL RESPONSE CHARACTERISTICS

- R5912, R5912-02
- R7081, R7081-20

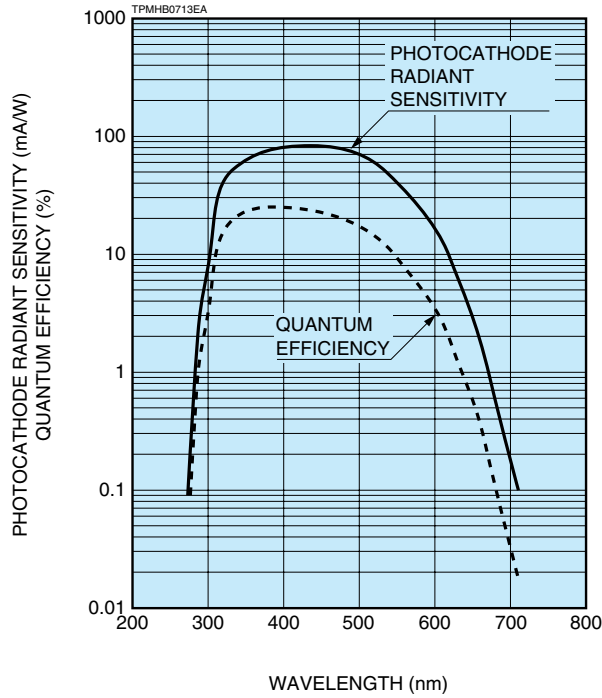

- R8055, R3600-02, R7250

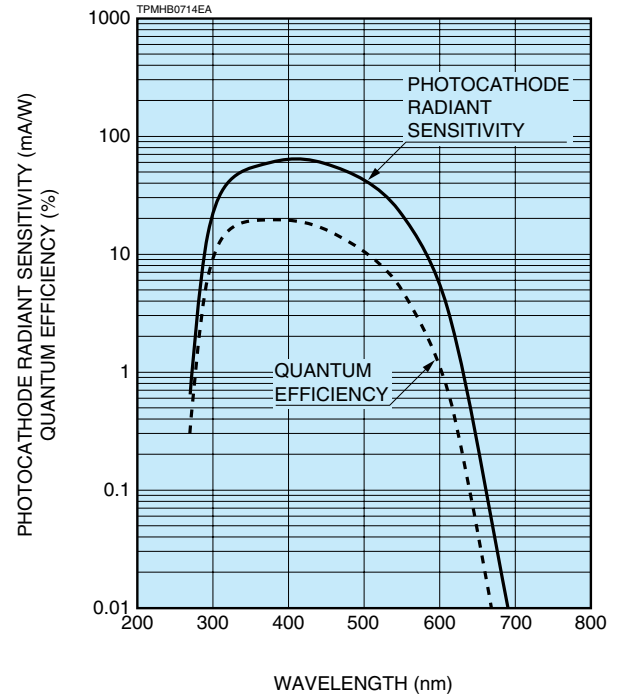

GAIN

●R5912, R5912-02

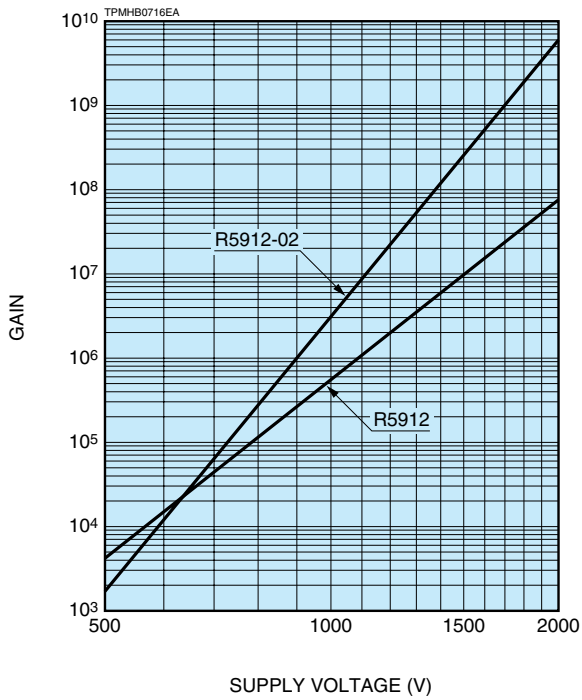

●R7081, R7081-20

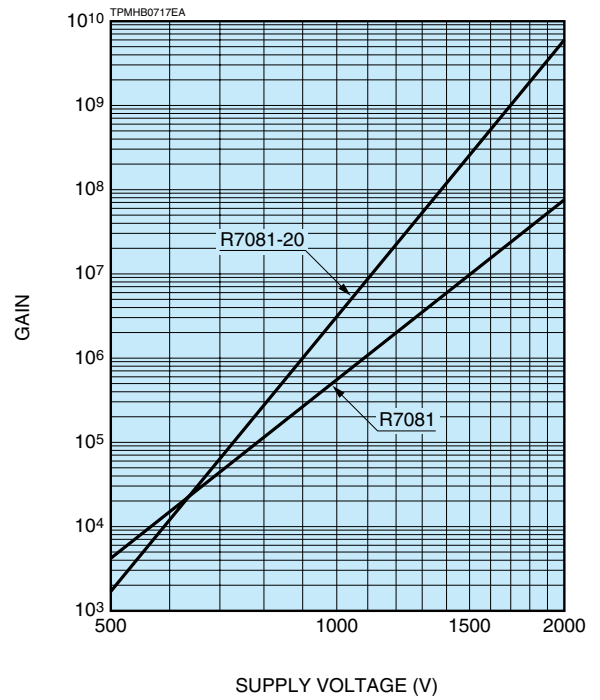

●R8055

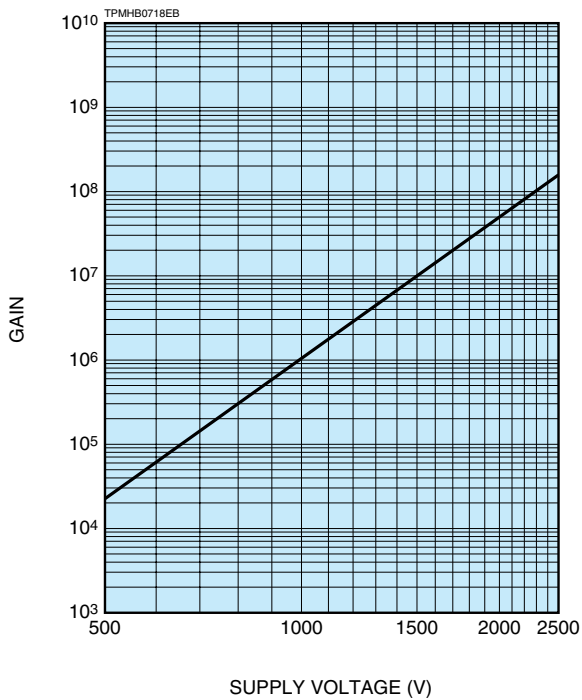

●R3600-02, R7250

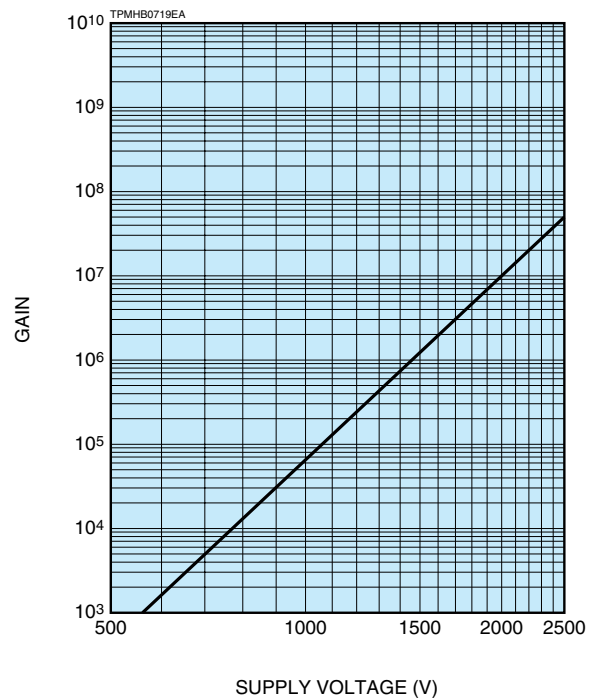

LARGE PHOTOCATHODE AREA PHOTOMULTIPLIER TUBES

TYPICAL TIME RESPONSE

●R5912, R5912-02

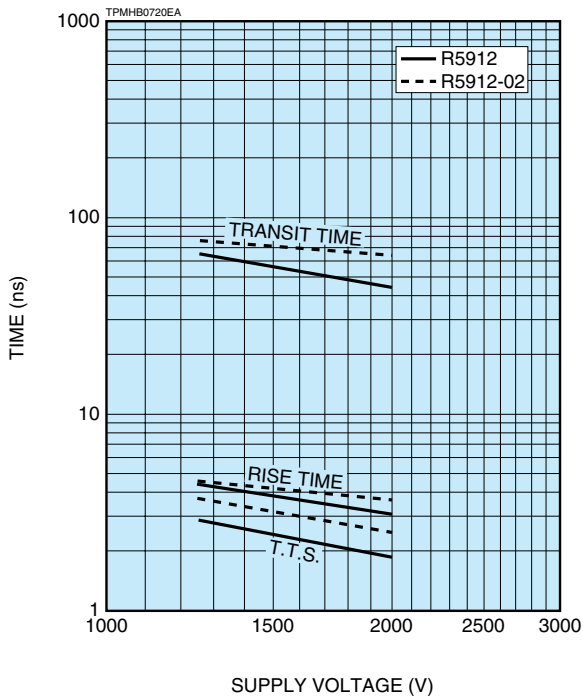

●R7081, R7081-20

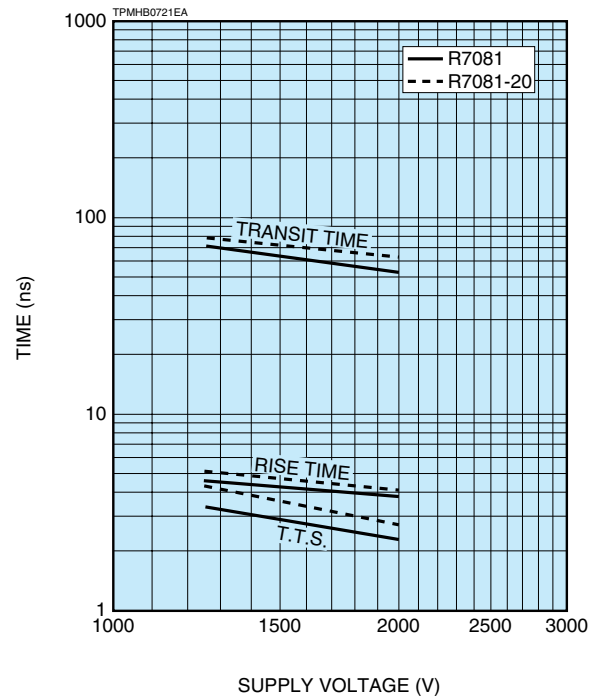

●R8055

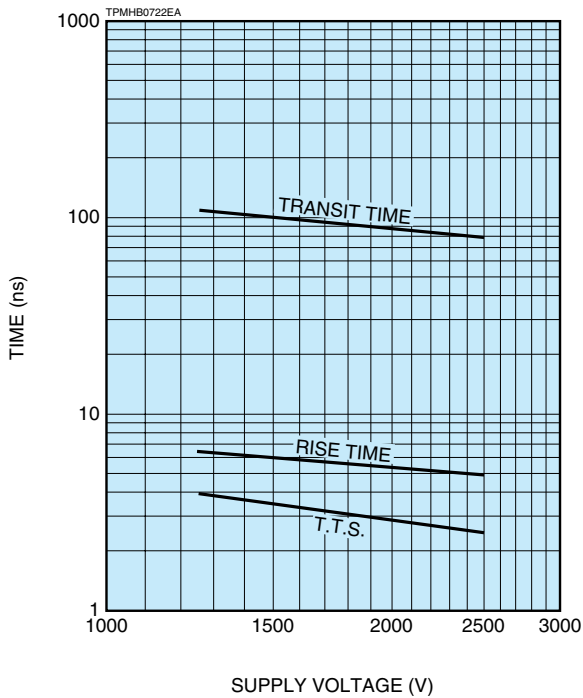

●R3600-02, R7250

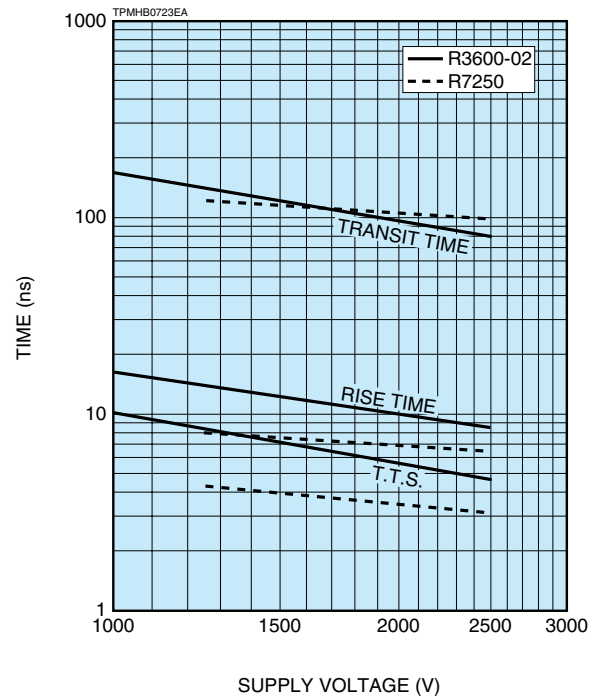

DIMENSIONAL OUTLINE (Unit: mm)

●R5912, R5912-02

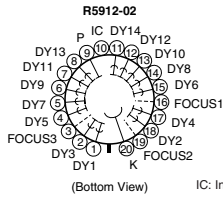
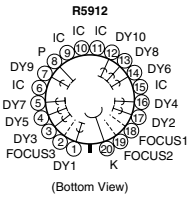
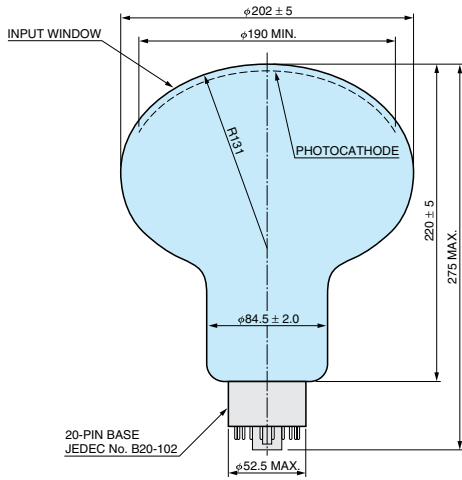

IC: Internal Connection
(Do not use)

TPMHA0500EA

●R7081, R7081-20

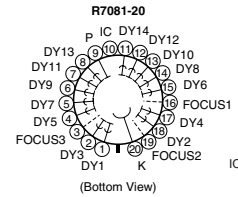
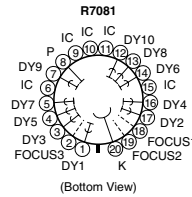
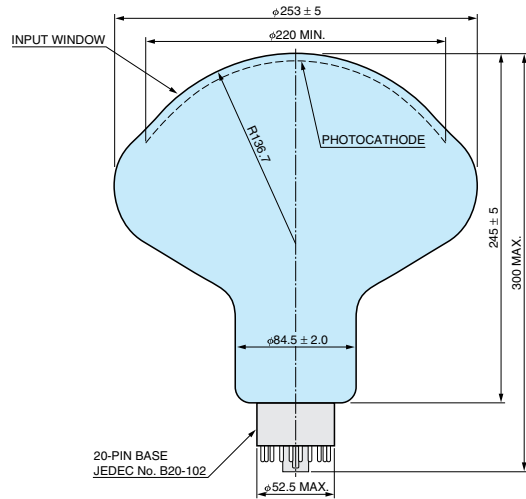

IC: Internal Connection
(Do not use)

TPMHA0501EA

●R8055

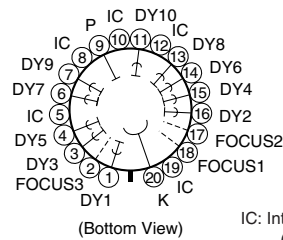
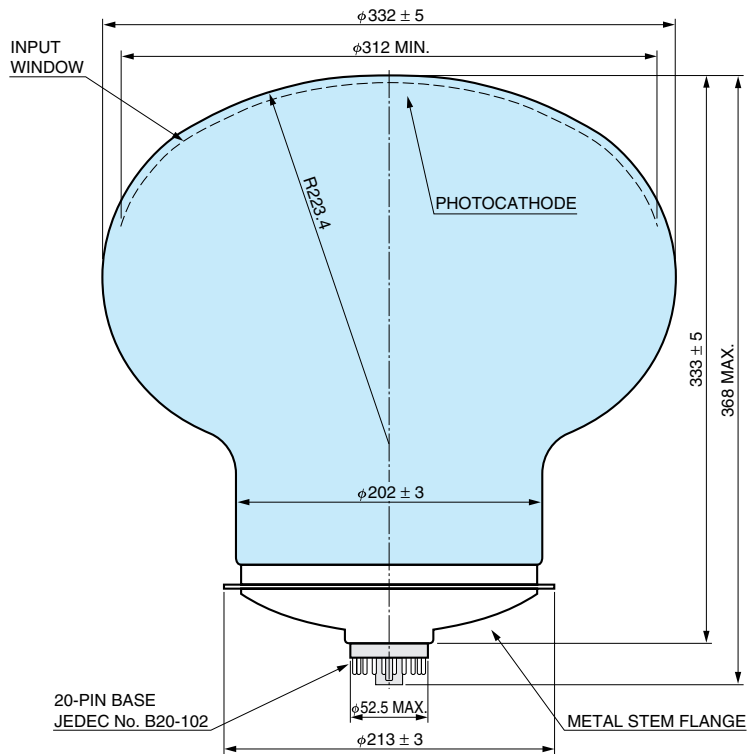

IC: Internal Connection
(Do not use)

TPMHA0502EA

LARGE PHOTOCATHODE AREA PHOTOMULTIPLIER TUBES

DIMENSIONAL OUTLINE (Unit: mm)

●R3600-02

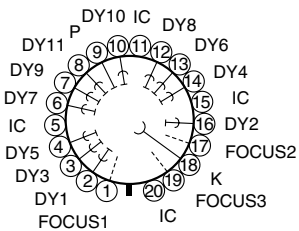
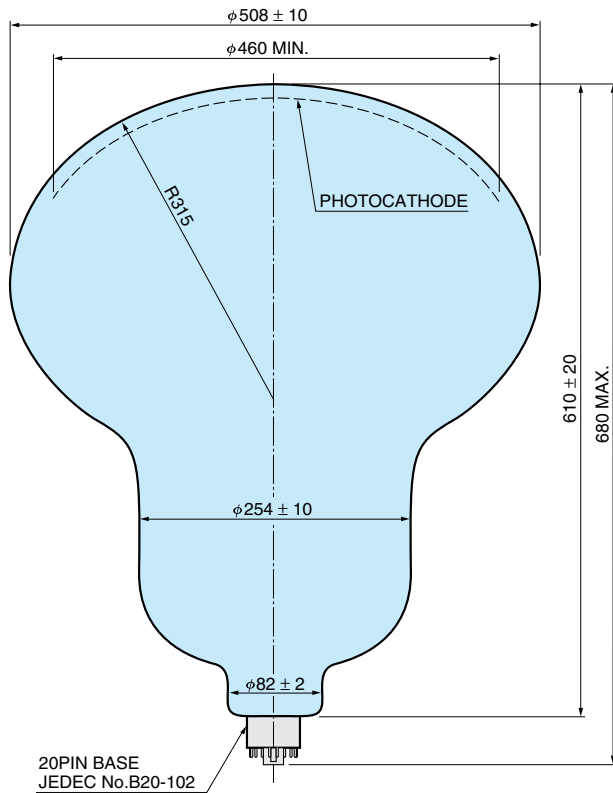

IC: Internal Connection
(Do not use)

TPMHA0092EE

●R7250

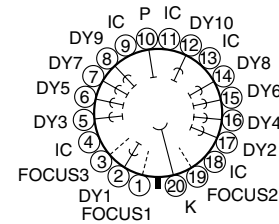
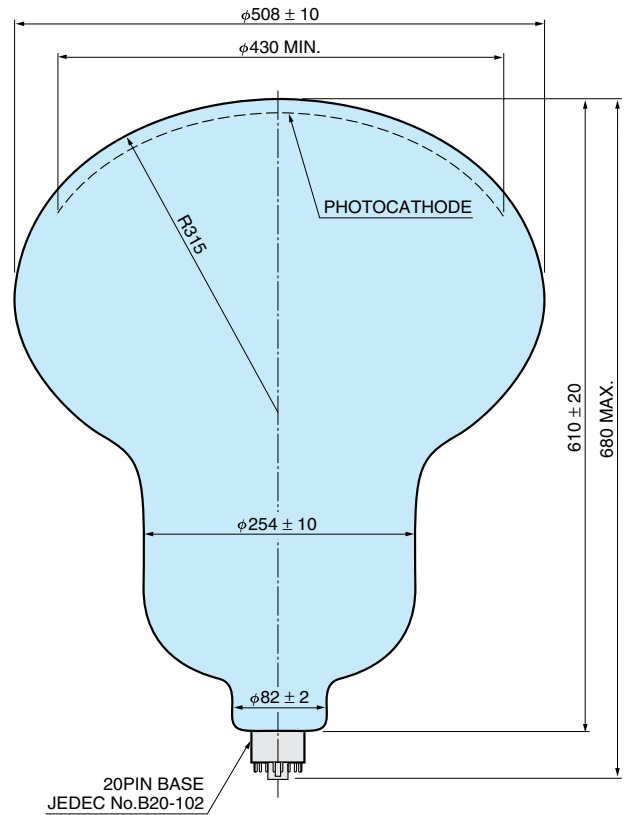

IC: Internal Connection
(Do not use)

TPMHA0475ED

HAMAMATSU

WEB SITE www.hamamatsu.com

HAMAMATSU PHOTONICS K.K., Electron Tube Division

314-5, Shimokanzo, Iwata City, Shizuoka Pref., 438-0193, Japan, Telephone: (81)539/62-5248, Fax: (81)539/62-2205

U.S.A.: Hamamatsu Corporation: 360 Foothill Road, P. O. Box 6910, Bridgewater, N.J. 08807-0910, U.S.A., Telephone: (1)908-231-0960, Fax: (1)908-231-1218 E-mail: usa@hamamatsu.com

Germany: Hamamatsu Photonics Deutschland GmbH: Arzbergerstr. 10, D-82211 Herrsching am Ammersee, Germany, Telephone: (49)8152-375-0, Fax: (49)8152-2658 E-mail: info@hamamatsu.de

France: Hamamatsu Photonics France S.A.R.L.: 19, Rue du Saule Trapu, Parc du Moulin de Massy, 91882 Massy Cedex, France, Telephone: (33)1 69 53 71 00, Fax: (33)1 69 53 71 10 E-mail: infos@hamamatsu.fr

United Kingdom: Hamamatsu Photonics UK Limited: 2 Howard Court, 10 Tewin Road Welwyn Garden City Hertfordshire AL7 1BW, United Kingdom, Telephone: 44-(0)1707-294888, Fax: 44(0)1707-325777 E-mail: info@hamamatsu.co.uk

North Europe: Hamamatsu Photonics Norden AB: Smidesvägen 12, SE-171-41 SOLNA, Sweden, Telephone: (46)8-509-031-00, Fax: (46)8-509-031-01 E-mail: info@hamamatsu.se

Italy: Hamamatsu Photonics Italia: S.R.L.: Strada della Moia, 1/E, 20020 Arese, (Milano), Italy, Telephone: (39)02-935 81 733, Fax: (39)02-935 81 741 E-mail: info@hamamatsu.it

TPMH1286E05
JAN. 2008 IP